

CLOSET CARRIERS

12000 Series Minimum Dimensions

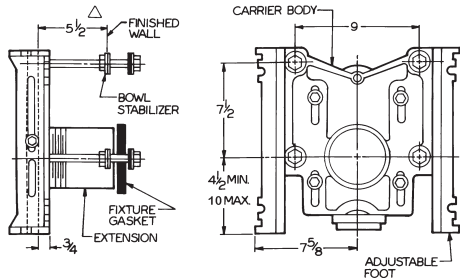

Carrier shown in Siphon Jet Position

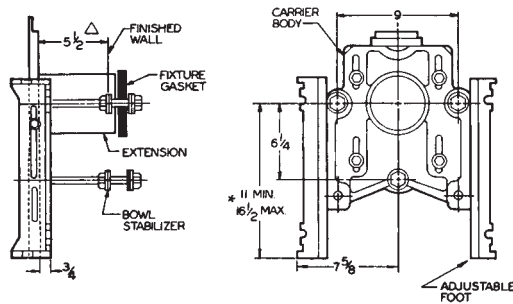

Carrier shown in Blowout Position

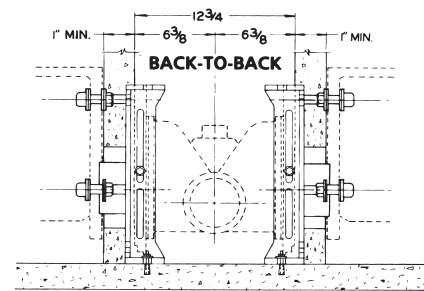
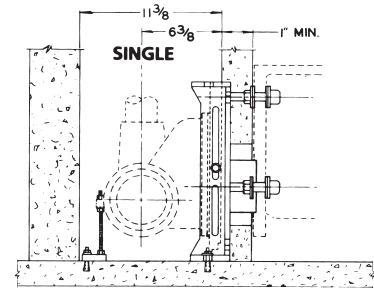

△ FOR DIM. SHORTER THAN 5-1/2" (1" MIN.), CUT EXT.
FOR LONGER EXT. (10-1/2" MAX.), SPECIFY -10 OPTION.
* FOR DIM. GREATER THAN 12-1/2", SPECIFY 12000-M1358.

-32 Option Minimum Dimensions

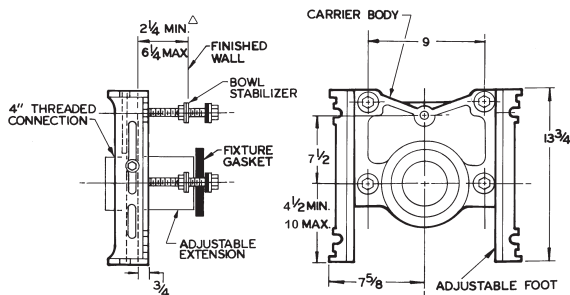

Carrier shown in Siphon Jet Position

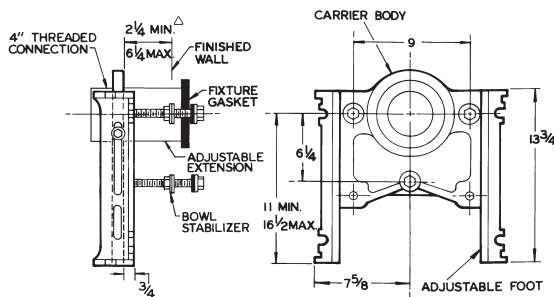

Carrier shown in Blowout Position

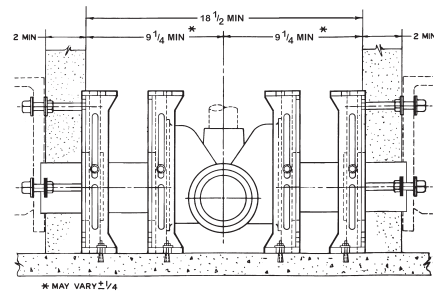
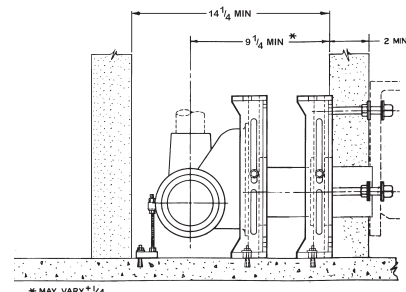

△ FOR DIM. LESS THAN 3-3/4" CUT EXT.
* MAY VARY ± 1/4"

ADJUSTABLE EXTENSIONS AVAILABLE FOR -32 OPTION

Wall Thickness	Length of Extension	Length of Threaded Rod	Part No.	Description
1" through 5-1/2"	7"	9-1/2"	07095A	ABS Extension
5-1/2" through 10-1/2"	12"	14-1/2"	07095E	ABS Extension