



**LIST PRICE
GUIDE 2008**

TABLE OF CONTENTS

Closet Carriers.....	3-4
Fixture Carriers.....	5-6
Roof Drains	7-10
Floor Drains.....	11-18
Stainless Steel Products	18-19
Sanitary Floor Sinks.....	20-22
Cleanouts.....	23-25
Interceptors.....	26-29
Backwater Valves	30
Hydrants	31
Shock Absorbers.....	32
Trench Drains	32-33
Miscellaneous Products	33
Traps & Accessories.....	34-35
PVC Products	36

HOW TO USE THIS PRICE GUIDE

Every product in this guide is provided with list prices for the product and its options in a concise table. The description of each option is shown in the lower right corner of each page spread. A thumbnail photo is included for quick identification. All drawings and dimensions are available at www.Josam.com.

All prices are list prices. Please consult your local Josam representative for your current multiplier.

 **WARNING:** Cancer and Reproductive Harm - www.p65warnings.ca.gov

Effective January 1, 2008

Plumbing Drainage Guide – 2008 (PDG-2008)

Supersedes all previously published terms and conditions. Subject to change without notice.

Applicable to all sales of, and contracts to sell products of Josam Company

CONTACT YOUR WHOLESALE FOR DETAILS ON DISCOUNT AND TERMS OF PAYMENT

PAYMENT TERMS:

For accounts with established credit, payment terms are 2% cash discount, payable 30 days from date of invoice, net 31 days. Invoices still unpaid after 31 days from date of invoice will be subject to interest charges of 1-1/2% per month. Minimum invoice: \$50.00 net. Confirmed irrevocable letter of credit or cash in advance of shipment is required for accounts without an established line of credit. Any terms and conditions appearing on your orders which are inconsistent with the terms of our quotation and conditions of sale shall be of no effect.

FREIGHT ALLOWANCE:

All shipments will be F.O.B. Michigan City, Indiana or Service Center. A freight allowance will be made on all shipments of \$5,000.00 net amount or more within the continental USA except for Alaska, Hawaii and Puerto Rico. Full freight allowance is limited to normal ground services and does not include charges for specially expedited or guaranteed deliveries requiring air shipment or guaranteed motor freight contracts.

RETURN POLICY:

Standard catalog material may be returned only upon written authorization of Seller. Credit will be issued to the Buyer's account toward purchase of additional material only. Obsolete, discontinued or specially produced items will not be accepted for return and credit.

When return results from causes involving Buyer's responsibility, credit for saleable goods returned will be issued at invoice price less a 25% restocking charge for handling and inspection. Return of less than \$100.00 net price will not be allowed. For other than saleable goods returned, any necessary charges to render the returned material saleable will be added. Galvanized material will be credited at the same value as painted cast iron. Chrome plated material will be credited at the value of satin finish bronze. On all returns, incoming and outgoing freight charges to and from Michigan City, Indiana, will be deducted from any credit allowed.

WARRANTY:

Our products are warranted to be free of defects in material and workmanship, but our liability shall be limited solely to those defects, which our inspection finds to be due to our fault. Notification of a claim for defective material or workmanship must be given in writing to Josam Company, Michigan City, Indiana within 60 days from date of shipment. **WE SHALL NOT BE RESPONSIBLE FOR ANY LABOR CHARGES OR ANY LOSS, INJURY OR DAMAGES WHATSOEVER, INCLUDING INCIDENTAL OR CONSEQUENTIAL DAMAGES.** The sole and exclusive remedy shall be limited to the replacement or repair of the defective goods at the Seller's discretion. Before installation and use, Buyer shall determine the suitability of the product for his intended use and the Buyer assumes all risk and liability whatever in connection therewith.

QUOTATIONS:

Quotations are based on discount in effect at the time of quotation and will be protected on this basis for a period of 30 days from job bid due date. If an order is received within this 30-day period, it must indicate a release of material for shipment within 60 days from date of order, and all released shipments will be protected at prices quoted. If order is not released by customer within this 60-day period, it will be priced at discount prevailing at time of shipment.

EXPORT ORDERS:

Factors which govern export orders differ from domestic orders. Please contact Josam International.

ACCEPTANCE OF ORDERS:

All catalogs, price lists or other literature describing our products are not to be construed as offers to sell same. All orders are subject to acceptance by the general office of Seller in Michigan City, Indiana, either by shipment or by written acceptance. Your order, when shipped or accepted by us, shall constitute the complete contract between us, subject to and incorporating therein the terms and conditions herein contained, and any inconsistent provisions contained in your order shall not apply. Prices, discounts and special programs contained in any of our catalogs, price lists or other literature are subject to change without notice.

CANCELLATION:

Orders are not subject to cancellation without our written consent. If an order is cancelled, the Buyer shall pay all costs incurred in connection with filling the order. Any items not cataloged or items not normally stocked by us and made or purchased to fill the order become the Buyer's property and must be paid for by the Buyer.

ILLUSTRATIONS, DESCRIPTIONS AND DIMENSIONS:

All illustrations, descriptions, and detailed dimensions represent standard features and do not necessarily indicate all variations available. All weights stated in our catalogs, literature and drawings are approximate and are not guaranteed.

All designs, descriptions and dimensions are subject to change without notice, and unless Buyer specifically states otherwise on order, standard products in effect at time order is shipped will be supplied.

RISKS:

Our responsibility ceases after the product has been delivered to the carrier in good order. It is the responsibility of the consignee to inspect each shipment carefully and file a claim with the carrier for any damage or shortage. Content shortages must be reported within 15 days after receipt of material.









DELIVERY:











Shipping dates are estimates and time of delivery is not the essence of this sale or the contract therefor. We will ship as near schedule as possible. Under no circumstances will the Seller have any responsibility on account of any delays in manufacture, transportation, or otherwise. Material is subject to shipment in whole or in part, at our option, and each shipment is subject to immediate invoicing.









TAXES:

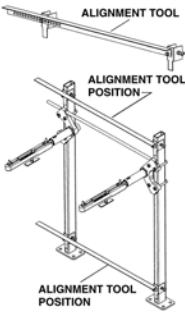



Any sales, or manufacturers' tax imposed under existing or future statutes shall be added to the price herewith effective and shall be paid by the Buyer unless proper exemption certificates are filed with Josam Company.

JOSAM COMPANY • MICHIGAN CITY, INDIANA 46360 • PHONE: (800) 365-6726 • FAX: (800) 627-0008

11001 11007 11008 	CLOSET CARRIERS LIST PRICE			12724 	VERTICAL ADJUSTABLE BACK-TO-BACK, NO-HUB, ON STACK LIST PRICE																																
	SERIES NO 11001 w/ 4" Pipe Grip Adapter \$330.00 11007 w/ 3" Copper Ftg. Adapter 350.00 11008 w/ 4" Copper Ftg. Adapter 350.00				SERIES NO 12724 Back-to-Back 2" Vent \$1,389.00 -HS \$1,423.00																																
12674 	HORIZONTAL NO-HUB ADJUSTABLE LIST PRICE			14004 	VERTICAL CLOSE HUB & SPIGOT, OFFSET LIST PRICE																																
	<table border="1"> <thead> <tr> <th>SERIES NO.</th> <th>12674 Single L.H.</th> <th>12684 Single R.H.</th> <th>12694 Back-to-Back</th> </tr> </thead> <tbody> <tr> <td>No-Hub</td> <td>\$694.00</td> <td>\$694.00</td> <td>\$1,295.00</td> </tr> <tr> <td>-HS</td> <td>694.00</td> <td>694.00</td> <td>1,295.00</td> </tr> <tr> <td>-58</td> <td>873.00</td> <td>873.00</td> <td>1,474.00</td> </tr> <tr> <td>-HS-58</td> <td>873.00</td> <td>873.00</td> <td>1,474.00</td> </tr> </tbody> </table>	SERIES NO.	12674 Single L.H.		12684 Single R.H.	12694 Back-to-Back	No-Hub	\$694.00	\$694.00	\$1,295.00	-HS	694.00	694.00	1,295.00	-58	873.00	873.00	1,474.00	-HS-58	873.00	873.00	1,474.00			<table border="1"> <thead> <tr> <th>SERIES NO</th> <th>No-Hub</th> <th>-HS</th> </tr> </thead> <tbody> <tr> <td>14004 Sgl. L.H., L.H. 2" Vent</td> <td></td> <td>\$623.00</td> </tr> <tr> <td>14024 Sgl. R.H., R.H. 2" Vent</td> <td></td> <td>623.00</td> </tr> <tr> <td>14044 Back-to-Back, 2" Vent</td> <td></td> <td>1,066.00</td> </tr> </tbody> </table>	SERIES NO	No-Hub	-HS	14004 Sgl. L.H., L.H. 2" Vent		\$623.00	14024 Sgl. R.H., R.H. 2" Vent		623.00	14044 Back-to-Back, 2" Vent		1,066.00
SERIES NO.	12674 Single L.H.	12684 Single R.H.	12694 Back-to-Back																																		
No-Hub	\$694.00	\$694.00	\$1,295.00																																		
-HS	694.00	694.00	1,295.00																																		
-58	873.00	873.00	1,474.00																																		
-HS-58	873.00	873.00	1,474.00																																		
SERIES NO	No-Hub	-HS																																			
14004 Sgl. L.H., L.H. 2" Vent		\$623.00																																			
14024 Sgl. R.H., R.H. 2" Vent		623.00																																			
14044 Back-to-Back, 2" Vent		1,066.00																																			
12684 Opposite (Not Shown)	ADD FOR OPTIONS: -PF.....\$0.00 -10.....\$0.00 -OR.....0.00 -24*.....Deduct 67.00 -SD*.....318.00 -30.....0.00 -HS.....0.00 -30-2.....0.00 -AUX**.....159.00 -32*.....211.00 -VP*.....57.00 -35.....0.00 -1*.....36.00 -58.....179.00 -6*.....37.00			14024 Opposite (Not Shown)	ADD FOR OPTIONS: -VP*.....\$57.00 -21*.....\$143.00 -1*.....36.00 -54.....159.00 -6*.....37.00																																
12694 	* Pricing for options is per fixture. Add or subtract twice for Back-to-Back Carriers ** Not Available on 12694.				14044 	* Pricing for options is per fixture. Add or subtract twice for Back-to-Back Carriers																															
12704 	VERTICAL ADJUSTABLE SINGLE, NO-HUB, ON STACK LIST PRICE			OPTION DESCRIPTIONS																																	
	<table border="1"> <thead> <tr> <th>SERIES NO</th> <th>No-Hub</th> <th>-HS</th> </tr> </thead> <tbody> <tr> <td>12704 L.Hand 2" Vent</td> <td>\$785.00</td> <td>\$819.00</td> </tr> <tr> <td>12714 R.Hand 2" Vent</td> <td>785.00</td> <td>819.00</td> </tr> </tbody> </table>	SERIES NO	No-Hub	-HS	12704 L.Hand 2" Vent	\$785.00	\$819.00	12714 R.Hand 2" Vent	785.00	819.00			-AUX Auxiliary Inlet, 2" -D4 Double 4" No-Hub Branches -HD4 Double 4" Hub Branches -HLH4 Left-Hand 4" Hub Branch -HRH4 Right-Hand 4" Hub Branch -HS Hub & Spigot -HVS4 Vent Side 4" Hub Branch -LH4 Left-Hand 4" No-Hub Branch -OR O-Ring Carrier -OS4 Opposite Vent 4" No-Hub Branch -PF Pylon Foot, Standard -RH4 Right-Hand 4" No-Hub Branch -SD Special-Duty 500 lb. Carrier -VP Vandal-Proof Trim -VS4 Vent Side 4" No-Hub Branch -1 Positioning Frame -6 Supply Pipe Support (Specify Galvanized or Copper Pipe) -10 ABS Extension through 10-1/2" Wall -21 Hanger Type Closet Adapter -24 Carrier for Floor-Mounted, Back-Outlet China Bowls -30 Cast Iron Adjustable Extension with Connector -30-2 Cast Iron Adjustable Extension with Connector and Test Cap -32 Carrier for Wide Chase Installations -35 Closet Carrier for Wheelchair High Rough -49 No-Hub High Auxiliary Inlet, Under Vent -50 No-Hub High Auxiliary Inlet, Opposite Vent -53 Threaded High Auxiliary Inlet, Under Vent -54 Threaded High Auxiliary Inlet, Opposite Vent -58 Horizontal No-Hub Cast Long Barrel																								
SERIES NO	No-Hub	-HS																																			
12704 L.Hand 2" Vent	\$785.00	\$819.00																																			
12714 R.Hand 2" Vent	785.00	819.00																																			
12714 	ADD FOR OPTIONS: -PF.....\$0.00 -6.....\$37.00 -OR.....0.00 -10.....0.00 -SD.....318.00 -24.....Deduct 67.00 -HS.....34.00 -30.....0.00 -LH4.....134.00 -30-2.....0.00 -HLH4.....134.00 -32.....211.00 -RH4.....134.00 -35.....0.00 -HRH4.....134.00 -49.....159.00 -D4.....269.00 -50.....159.00 -HD4.....269.00 -53.....159.00 -VP.....57.00 -54.....159.00 -1.....36.00																																				

<p>14064</p>  <p>14104</p> 	<p style="text-align: center;">VERTICAL CLOSE HUB & SPIGOT, ON STACK</p> <table border="1"> <thead> <tr> <th colspan="2">LIST PRICE</th> </tr> </thead> <tbody> <tr> <td colspan="2">SERIES NO</td> </tr> <tr> <td>14064 Sgl., 4" Vent</td> <td>\$623.00</td> </tr> <tr> <td>14104 Sgl., 2" Vent</td> <td>623.00</td> </tr> <tr> <td colspan="2">ADD FOR OPTIONS:</td> </tr> <tr> <td>-SD</td> <td>\$318.00</td> </tr> <tr> <td>-VP</td> <td>57.00</td> </tr> <tr> <td>-1</td> <td>36.00</td> </tr> <tr> <td>-6</td> <td>\$37.00</td> </tr> <tr> <td>-45</td> <td>159.00</td> </tr> <tr> <td>-46</td> <td>159.00</td> </tr> </tbody> </table>	LIST PRICE		SERIES NO		14064 Sgl., 4" Vent	\$623.00	14104 Sgl., 2" Vent	623.00	ADD FOR OPTIONS:		-SD	\$318.00	-VP	57.00	-1	36.00	-6	\$37.00	-45	159.00	-46	159.00	<p>15964</p> 	<p style="text-align: center;">90° INSTITUTIONAL FITTING VERTICAL NO-HUB, ON STACK</p> <table border="1"> <thead> <tr> <th colspan="2">LIST PRICE</th> </tr> </thead> <tbody> <tr> <td colspan="2">SERIES NO</td> </tr> <tr> <td>15964 Double Waste Fitting with Vent and Carriers</td> <td>\$1,887.00</td> </tr> <tr> <td colspan="2">ADD FOR OPTIONS:</td> </tr> <tr> <td>-VP</td> <td>\$114.00</td> </tr> <tr> <td>-1</td> <td>72.00</td> </tr> <tr> <td>-6</td> <td>74.00</td> </tr> <tr> <td>-10</td> <td>0.00</td> </tr> <tr> <td>-24</td> <td>Deduct 134.00</td> </tr> <tr> <td>-26</td> <td>\$0.00</td> </tr> <tr> <td>-30</td> <td>0.00</td> </tr> <tr> <td>-30-2</td> <td>0.00</td> </tr> <tr> <td>-49</td> <td>159.00</td> </tr> <tr> <td>-54</td> <td>159.00</td> </tr> </tbody> </table>	LIST PRICE		SERIES NO		15964 Double Waste Fitting with Vent and Carriers	\$1,887.00	ADD FOR OPTIONS:		-VP	\$114.00	-1	72.00	-6	74.00	-10	0.00	-24	Deduct 134.00	-26	\$0.00	-30	0.00	-30-2	0.00	-49	159.00	-54	159.00
LIST PRICE																																																					
SERIES NO																																																					
14064 Sgl., 4" Vent	\$623.00																																																				
14104 Sgl., 2" Vent	623.00																																																				
ADD FOR OPTIONS:																																																					
-SD	\$318.00																																																				
-VP	57.00																																																				
-1	36.00																																																				
-6	\$37.00																																																				
-45	159.00																																																				
-46	159.00																																																				
LIST PRICE																																																					
SERIES NO																																																					
15964 Double Waste Fitting with Vent and Carriers	\$1,887.00																																																				
ADD FOR OPTIONS:																																																					
-VP	\$114.00																																																				
-1	72.00																																																				
-6	74.00																																																				
-10	0.00																																																				
-24	Deduct 134.00																																																				
-26	\$0.00																																																				
-30	0.00																																																				
-30-2	0.00																																																				
-49	159.00																																																				
-54	159.00																																																				
<p>14404</p>  <p>14424 Opposite (Not Shown)</p> <p>14444</p> 	<p style="text-align: center;">VERTICAL CLOSE NO-HUB, OFFSET</p> <table border="1"> <thead> <tr> <th colspan="2">LIST PRICE</th> </tr> </thead> <tbody> <tr> <td colspan="2">SERIES NO</td> </tr> <tr> <td>14404 Sgl. L.H., L.H. 2" Vent</td> <td>\$623.00</td> </tr> <tr> <td>14424 Sgl. R.H., R.H. 2" Vent</td> <td>623.00</td> </tr> <tr> <td>14444 Back-to-Back, 2" Vent</td> <td>1,066.00</td> </tr> <tr> <td colspan="2">ADD FOR OPTIONS:</td> </tr> <tr> <td>-SD*</td> <td>\$318.00</td> </tr> <tr> <td>-VP*</td> <td>57.00</td> </tr> <tr> <td>-1*</td> <td>36.00</td> </tr> <tr> <td>-6*</td> <td>37.00</td> </tr> <tr> <td>-10</td> <td>0.00</td> </tr> <tr> <td>-24*</td> <td>Deduct \$67.00</td> </tr> <tr> <td>-30</td> <td>0.00</td> </tr> <tr> <td>-30-2</td> <td>0.00</td> </tr> <tr> <td>-50</td> <td>159.00</td> </tr> <tr> <td>-54</td> <td>159.00</td> </tr> </tbody> </table> <p>* Pricing for options is per fixture. Add or subtract twice for Back-to-Back Carriers</p>	LIST PRICE		SERIES NO		14404 Sgl. L.H., L.H. 2" Vent	\$623.00	14424 Sgl. R.H., R.H. 2" Vent	623.00	14444 Back-to-Back, 2" Vent	1,066.00	ADD FOR OPTIONS:		-SD*	\$318.00	-VP*	57.00	-1*	36.00	-6*	37.00	-10	0.00	-24*	Deduct \$67.00	-30	0.00	-30-2	0.00	-50	159.00	-54	159.00	<p>15984</p> 	<p style="text-align: center;">90° INSTITUTIONAL FITTING VERTICAL NO-HUB, ON STACK</p> <table border="1"> <thead> <tr> <th colspan="2">LIST PRICE</th> </tr> </thead> <tbody> <tr> <td colspan="2">SERIES NO</td> </tr> <tr> <td>15984 Double Waste Fitting, No-Hub Branches, 2" Vent</td> <td>\$718.00</td> </tr> <tr> <td colspan="2">ADD FOR OPTIONS:</td> </tr> <tr> <td>-26</td> <td>\$0.00</td> </tr> <tr> <td>-49</td> <td>159.00</td> </tr> <tr> <td>-54</td> <td>\$159.00</td> </tr> </tbody> </table>	LIST PRICE		SERIES NO		15984 Double Waste Fitting, No-Hub Branches, 2" Vent	\$718.00	ADD FOR OPTIONS:		-26	\$0.00	-49	159.00	-54	\$159.00				
LIST PRICE																																																					
SERIES NO																																																					
14404 Sgl. L.H., L.H. 2" Vent	\$623.00																																																				
14424 Sgl. R.H., R.H. 2" Vent	623.00																																																				
14444 Back-to-Back, 2" Vent	1,066.00																																																				
ADD FOR OPTIONS:																																																					
-SD*	\$318.00																																																				
-VP*	57.00																																																				
-1*	36.00																																																				
-6*	37.00																																																				
-10	0.00																																																				
-24*	Deduct \$67.00																																																				
-30	0.00																																																				
-30-2	0.00																																																				
-50	159.00																																																				
-54	159.00																																																				
LIST PRICE																																																					
SERIES NO																																																					
15984 Double Waste Fitting, No-Hub Branches, 2" Vent	\$718.00																																																				
ADD FOR OPTIONS:																																																					
-26	\$0.00																																																				
-49	159.00																																																				
-54	\$159.00																																																				
<p>14464</p>  <p>14484</p> 	<p style="text-align: center;">VERTICAL CLOSE NO-HUB, ON STACK</p> <table border="1"> <thead> <tr> <th colspan="2">LIST PRICE</th> </tr> </thead> <tbody> <tr> <td colspan="2">SERIES NO</td> </tr> <tr> <td>14464 Single, 4" Vent</td> <td>\$623.00</td> </tr> <tr> <td>14484 Back-to-Back, 4" Vent Siphon Jet Closets Only</td> <td>1,102.00</td> </tr> <tr> <td colspan="2">ADD FOR OPTIONS:</td> </tr> <tr> <td>-SD*</td> <td>\$318.00</td> </tr> <tr> <td>-VP*</td> <td>57.00</td> </tr> <tr> <td>-1*</td> <td>36.00</td> </tr> <tr> <td>-6*</td> <td>37.00</td> </tr> <tr> <td>-10</td> <td>0.00</td> </tr> <tr> <td>-24*</td> <td>Deduct \$67.00</td> </tr> <tr> <td>-30</td> <td>0.00</td> </tr> <tr> <td>-30-2</td> <td>0.00</td> </tr> <tr> <td>-45</td> <td>159.00</td> </tr> <tr> <td>-46</td> <td>159.00</td> </tr> </tbody> </table> <p>* Pricing for options is per fixture. Add or subtract twice for Back-to-Back Carriers</p>	LIST PRICE		SERIES NO		14464 Single, 4" Vent	\$623.00	14484 Back-to-Back, 4" Vent Siphon Jet Closets Only	1,102.00	ADD FOR OPTIONS:		-SD*	\$318.00	-VP*	57.00	-1*	36.00	-6*	37.00	-10	0.00	-24*	Deduct \$67.00	-30	0.00	-30-2	0.00	-45	159.00	-46	159.00	<p>16123</p> 	<p style="text-align: center;">FLOOR-MOUNT PVC ADAPTER TYPE, ON STACK</p> <table border="1"> <thead> <tr> <th colspan="2">LIST PRICE</th> </tr> </thead> <tbody> <tr> <td colspan="2">SERIES NO</td> </tr> <tr> <td>16123 Single, for PVC Pipe Siphon Jet Closets Only</td> <td>\$448.00</td> </tr> <tr> <td colspan="2">ADD FOR OPTIONS:</td> </tr> <tr> <td>-VP</td> <td>\$57.00</td> </tr> <tr> <td>-1</td> <td>36.00</td> </tr> <tr> <td>-6</td> <td>37.00</td> </tr> <tr> <td>-13</td> <td>\$0.00</td> </tr> <tr> <td>-21</td> <td>143.00</td> </tr> </tbody> </table>	LIST PRICE		SERIES NO		16123 Single, for PVC Pipe Siphon Jet Closets Only	\$448.00	ADD FOR OPTIONS:		-VP	\$57.00	-1	36.00	-6	37.00	-13	\$0.00	-21	143.00		
LIST PRICE																																																					
SERIES NO																																																					
14464 Single, 4" Vent	\$623.00																																																				
14484 Back-to-Back, 4" Vent Siphon Jet Closets Only	1,102.00																																																				
ADD FOR OPTIONS:																																																					
-SD*	\$318.00																																																				
-VP*	57.00																																																				
-1*	36.00																																																				
-6*	37.00																																																				
-10	0.00																																																				
-24*	Deduct \$67.00																																																				
-30	0.00																																																				
-30-2	0.00																																																				
-45	159.00																																																				
-46	159.00																																																				
LIST PRICE																																																					
SERIES NO																																																					
16123 Single, for PVC Pipe Siphon Jet Closets Only	\$448.00																																																				
ADD FOR OPTIONS:																																																					
-VP	\$57.00																																																				
-1	36.00																																																				
-6	37.00																																																				
-13	\$0.00																																																				
-21	143.00																																																				
<p>14504</p> 	<p style="text-align: center;">VERTICAL CLOSE NO-HUB, ON STACK</p> <table border="1"> <thead> <tr> <th colspan="2">LIST PRICE</th> </tr> </thead> <tbody> <tr> <td colspan="2">SERIES NO</td> </tr> <tr> <td>14504 Single, 2" Vent</td> <td>\$623.00</td> </tr> <tr> <td colspan="2">ADD FOR OPTIONS:</td> </tr> <tr> <td>-SD</td> <td>\$318.00</td> </tr> <tr> <td>-VP</td> <td>57.00</td> </tr> <tr> <td>-1</td> <td>36.00</td> </tr> <tr> <td>-6</td> <td>37.00</td> </tr> <tr> <td>-10</td> <td>0.00</td> </tr> <tr> <td>-24</td> <td>Deduct \$67.00</td> </tr> <tr> <td>-30</td> <td>0.00</td> </tr> <tr> <td>-30-2</td> <td>0.00</td> </tr> <tr> <td>-45</td> <td>159.00</td> </tr> <tr> <td>-46</td> <td>159.00</td> </tr> </tbody> </table>	LIST PRICE		SERIES NO		14504 Single, 2" Vent	\$623.00	ADD FOR OPTIONS:		-SD	\$318.00	-VP	57.00	-1	36.00	-6	37.00	-10	0.00	-24	Deduct \$67.00	-30	0.00	-30-2	0.00	-45	159.00	-46	159.00	<p>Closet Carrier OPTION DESCRIPTIONS</p> <ul style="list-style-type: none"> -SD Special-Duty 500 lb. Carrier -VP Vandal-Proof Trim -1 Positioning Frame -6 Supply Pipe Support (Specify Galvanized or Copper Pipe) -10 ABS Extension through 10-1/2" Wall -13 3" ABS Fitting Adapter -21 Hanger Type Closet Adapter -24 Carrier for Floor-Mounted, Back-Outlet China Bowls -26 Fitting Anchor Foot -30 Cast Iron Adjustable Extension with Connector -30-2 Cast Iron Adjustable Extension with Connector and Test Cap -45 Threaded Left-Hand Auxiliary Inlet -46 Threaded Right-Hand Auxiliary Inlet -49 No-Hub High Auxiliary Inlet, Under Vent -50 No-Hub High Auxiliary Inlet, Opposite Vent -54 Threaded High Auxiliary Inlet, Opposite Vent 																							
LIST PRICE																																																					
SERIES NO																																																					
14504 Single, 2" Vent	\$623.00																																																				
ADD FOR OPTIONS:																																																					
-SD	\$318.00																																																				
-VP	57.00																																																				
-1	36.00																																																				
-6	37.00																																																				
-10	0.00																																																				
-24	Deduct \$67.00																																																				
-30	0.00																																																				
-30-2	0.00																																																				
-45	159.00																																																				
-46	159.00																																																				

 <p>17000</p>	<p align="center">REUSABLE ALIGNMENT TOOL</p> <table border="1"> <thead> <tr> <th colspan="3">LIST PRICE</th> </tr> </thead> <tbody> <tr> <td>TYPE NO.</td> <td>17000</td> <td>\$118.00</td> </tr> </tbody> </table>	LIST PRICE			TYPE NO.	17000	\$118.00	 <p>17390</p>	<p align="center">WALL-MOUNT ADJUSTABLE EXPOSED ARMS</p> <table border="1"> <thead> <tr> <th colspan="3">LIST PRICE</th> </tr> </thead> <tbody> <tr> <td>TYPE NO.</td> <td>17390</td> <td>\$428.00</td> </tr> </tbody> </table> <p>ADD FOR OPTIONS: -BP.....\$0.00 -VP.....\$57.00 -10*.....\$21.00</p> <p>* Hardware for Walls over 4-1/2", Specify Wall Thickness, Price Per Inch</p>	LIST PRICE			TYPE NO.	17390	\$428.00																																						
LIST PRICE																																																					
TYPE NO.	17000	\$118.00																																																			
LIST PRICE																																																					
TYPE NO.	17390	\$428.00																																																			
 <p>17100</p>	<p align="center">FLOOR-MOUNT ADJUSTABLE CONCEALED ARMS</p> <table border="1"> <thead> <tr> <th colspan="3">LIST PRICE</th> </tr> </thead> <tbody> <tr> <td>TYPE NO.</td> <td>17100</td> <td>17100-BB</td> </tr> <tr> <td></td> <td>\$432.00</td> <td>\$615.00</td> </tr> </tbody> </table> <p>ADD FOR OPTIONS:</p> <table border="1"> <thead> <tr> <th>17100</th> <th>17100-BB</th> </tr> </thead> <tbody> <tr><td>-BB</td><td>\$183.00</td></tr> <tr><td>-10*</td><td>21.00</td></tr> <tr><td>-60</td><td>64.00</td></tr> <tr><td>-67</td><td>29.00</td></tr> <tr><td>-75</td><td>71.00</td></tr> <tr><td>-76</td><td>129.00</td></tr> <tr><td>-77</td><td>129.00</td></tr> </tbody> </table> <p>ABOVE ABOVE ABOVE ABOVE ABOVE ABOVE ABOVE</p> <p>* Extension Sleeves Longer than 6-1/2", Specify Wall Thickness, Price Per Inch.</p>	LIST PRICE			TYPE NO.	17100	17100-BB		\$432.00	\$615.00	17100	17100-BB	-BB	\$183.00	-10*	21.00	-60	64.00	-67	29.00	-75	71.00	-76	129.00	-77	129.00	 <p>17405</p>	<p align="center">WALL-MOUNT EXPOSED ARMS ONLY</p> <table border="1"> <thead> <tr> <th colspan="3">LIST PRICE</th> </tr> </thead> <tbody> <tr> <td>TYPE NO.</td> <td>17405</td> <td>\$277.00</td> </tr> </tbody> </table> <p>ADD FOR OPTIONS: -VP.....\$57.00 -10*.....\$21.00</p> <p>* Hardware for Walls over 4", Specify Wall Thickness, Price Per Inch</p>	LIST PRICE			TYPE NO.	17405	\$277.00																			
LIST PRICE																																																					
TYPE NO.	17100	17100-BB																																																			
	\$432.00	\$615.00																																																			
17100	17100-BB																																																				
-BB	\$183.00																																																				
-10*	21.00																																																				
-60	64.00																																																				
-67	29.00																																																				
-75	71.00																																																				
-76	129.00																																																				
-77	129.00																																																				
LIST PRICE																																																					
TYPE NO.	17405	\$277.00																																																			
 <p>17120</p>	<p align="center">WALL-MOUNT ADJUSTABLE CONCEALED ARMS</p> <table border="1"> <thead> <tr> <th colspan="3">LIST PRICE</th> </tr> </thead> <tbody> <tr> <td>TYPE NO.</td> <td>17120</td> <td>\$255.00</td> </tr> </tbody> </table> <p>ADD FOR OPTIONS:</p> <table border="1"> <tbody> <tr> <td>-BP</td> <td>\$0.00</td> <td>-76</td> <td>\$129.00</td> </tr> <tr> <td>-MMB.....</td> <td>Deduct 54.00</td> <td>-77</td> <td>129.00</td> </tr> <tr> <td>-10*</td> <td>21.00</td> <td></td> <td></td> </tr> <tr> <td>-75</td> <td>71.00</td> <td></td> <td></td> </tr> </tbody> </table> <p>* Extension Sleeves Longer than 4", Specify Wall Thickness, Price Per Inch</p>	LIST PRICE			TYPE NO.	17120	\$255.00	-BP	\$0.00	-76	\$129.00	-MMB.....	Deduct 54.00	-77	129.00	-10*	21.00			-75	71.00			 <p>17550</p>	<p align="center">FLOOR-MOUNT HANGER PLATE TYPE</p> <table border="1"> <thead> <tr> <th colspan="4">LIST PRICE</th> </tr> </thead> <tbody> <tr> <td>17550</td> <td>17550-BB</td> <td>17550-UR</td> <td>17550-WCBL</td> </tr> <tr> <td>\$ 327.00</td> <td>\$432.00</td> <td>\$327.00</td> <td>\$535.00</td> </tr> </tbody> </table> <p>ADD FOR OPTIONS:</p> <table border="1"> <thead> <tr> <th>17550</th> <th>17550-BB</th> </tr> </thead> <tbody> <tr><td>-BB</td><td>\$105.00</td></tr> <tr><td>-CL</td><td>124.00</td></tr> <tr><td>-UR**</td><td>0.00</td></tr> <tr><td>-WC**</td><td>0.00</td></tr> <tr><td>-WCBL**</td><td>208.00</td></tr> <tr><td>-10*</td><td>21.00</td></tr> <tr><td>-60</td><td>64.00</td></tr> </tbody> </table> <p>ABOVE ----- ----- ----- ----- ----- \$42.00 128.00</p> <p>* Hardware for Walls over 4", Specify Wall Thickness, Price Per Inch ** Cannot be Furnished with -60</p>	LIST PRICE				17550	17550-BB	17550-UR	17550-WCBL	\$ 327.00	\$432.00	\$327.00	\$535.00	17550	17550-BB	-BB	\$105.00	-CL	124.00	-UR**	0.00	-WC**	0.00	-WCBL**	208.00	-10*	21.00	-60	64.00
LIST PRICE																																																					
TYPE NO.	17120	\$255.00																																																			
-BP	\$0.00	-76	\$129.00																																																		
-MMB.....	Deduct 54.00	-77	129.00																																																		
-10*	21.00																																																				
-75	71.00																																																				
LIST PRICE																																																					
17550	17550-BB	17550-UR	17550-WCBL																																																		
\$ 327.00	\$432.00	\$327.00	\$535.00																																																		
17550	17550-BB																																																				
-BB	\$105.00																																																				
-CL	124.00																																																				
-UR**	0.00																																																				
-WC**	0.00																																																				
-WCBL**	208.00																																																				
-10*	21.00																																																				
-60	64.00																																																				
 <p>17125</p>	<p align="center">WALL-MOUNT, NON-ADJUSTABLE CONCEALED ARMS</p> <table border="1"> <thead> <tr> <th colspan="3">LIST PRICE</th> </tr> </thead> <tbody> <tr> <td>TYPE NO.</td> <td>17125</td> <td>\$199.00</td> </tr> </tbody> </table> <p>ADD FOR OPTIONS:</p> <table border="1"> <tbody> <tr> <td>-10*</td> <td>\$21.00</td> <td>-75.....</td> <td>\$71.00</td> </tr> </tbody> </table> <p>* Extension Sleeves Longer than 4", Specify Wall Thickness, Price Per Inch</p>	LIST PRICE			TYPE NO.	17125	\$199.00	-10*	\$21.00	-75.....	\$71.00	<p align="center">Fixture Carrier OPTION DESCRIPTIONS</p> <ul style="list-style-type: none"> -BB Back-to-Back Carrier -BP with Back Plates -CL Corner Lavatory Carrier -HD Heavy-Duty -MMB with Movable Mounting Brackets -UR Urinal Carrier -VP Vandal-Proof Trim -WC Water Cooler Carrier -WCBL Water Cooler Bi-Level Carrier -10 Extension Sleeves or Hardware for Thicker Walls, See Product -60 Valve Plate for Attaching to Upright -66 Split Header for Stainless Steel Arms -67 Concealed Arm Carrier for Wheelchair Lavatory -75 2" Chrome Plated Escutcheons -76 4" Chrome Plated Escutcheons -77 6" Chrome Plated Escutcheons 																																									
LIST PRICE																																																					
TYPE NO.	17125	\$199.00																																																			
-10*	\$21.00	-75.....	\$71.00																																																		
 <p>17380</p>	<p align="center">FLOOR-MOUNT ADJUSTABLE EXPOSED ARMS</p> <table border="1"> <thead> <tr> <th colspan="3">LIST PRICE</th> </tr> </thead> <tbody> <tr> <td>TYPE NO.</td> <td>17380</td> <td>17380-BB</td> </tr> <tr> <td></td> <td>\$616.00</td> <td>\$967.00</td> </tr> </tbody> </table> <p>ADD FOR OPTIONS:</p> <table border="1"> <thead> <tr> <th>17380</th> <th>17380-BB</th> </tr> </thead> <tbody> <tr><td>-BB**</td><td>\$351.00</td></tr> <tr><td>-HD</td><td>73.00</td></tr> <tr><td>-VP</td><td>57.00</td></tr> <tr><td>-10*</td><td>21.00</td></tr> <tr><td>-60</td><td>64.00</td></tr> <tr><td>-66**</td><td>P.O.A.*</td></tr> </tbody> </table> <p>ABOVE ABOVE ABOVE ABOVE ABOVE ABOVE ABOVE</p> <p>* Hardware for Walls over 4-1/2", Specify Wall Thickness, Price Per Inch" ** -66 cannot be Furnished with -BB. • Price on Application</p>	LIST PRICE			TYPE NO.	17380	17380-BB		\$616.00	\$967.00	17380	17380-BB	-BB**	\$351.00	-HD	73.00	-VP	57.00	-10*	21.00	-60	64.00	-66**	P.O.A.*																													
LIST PRICE																																																					
TYPE NO.	17380	17380-BB																																																			
	\$616.00	\$967.00																																																			
17380	17380-BB																																																				
-BB**	\$351.00																																																				
-HD	73.00																																																				
-VP	57.00																																																				
-10*	21.00																																																				
-60	64.00																																																				
-66**	P.O.A.*																																																				

	<p align="center">FLOOR-MOUNT BEARING PLATE TYPE</p> <table border="1"> <thead> <tr> <th colspan="4">LIST PRICE</th> </tr> <tr> <th>17560</th> <th>17560-BB</th> <th>17560-UR 17560-WC</th> <th>17560-WCBL</th> </tr> </thead> <tbody> <tr> <td>\$365.00</td> <td>\$509.00</td> <td>\$365.00</td> <td>\$723.00</td> </tr> </tbody> </table> <p>ADD FOR OPTIONS:</p> <table border="1"> <thead> <tr> <th></th> <th>17560</th> <th>17560-BB</th> </tr> </thead> <tbody> <tr> <td>-BB</td> <td>\$144.00</td> <td>ABOVE</td> </tr> <tr> <td>-UR**</td> <td>0.00</td> <td>----</td> </tr> <tr> <td>-WC**</td> <td>0.00</td> <td>----</td> </tr> <tr> <td>-WCBL**</td> <td>358.00</td> <td>----</td> </tr> <tr> <td>-10*</td> <td>21.00</td> <td>\$42.00</td> </tr> <tr> <td>-60</td> <td>64.00</td> <td>128.00</td> </tr> </tbody> </table> <p>* Hardware for Walls over 4", Specify Wall Thickness, Price Per Inch ** Cannot be Furnished with -60</p>	LIST PRICE				17560	17560-BB	17560-UR 17560-WC	17560-WCBL	\$365.00	\$509.00	\$365.00	\$723.00		17560	17560-BB	-BB	\$144.00	ABOVE	-UR**	0.00	----	-WC**	0.00	----	-WCBL**	358.00	----	-10*	21.00	\$42.00	-60	64.00	128.00	<p>Fixture Carrier OPTION DESCRIPTIONS</p> <ul style="list-style-type: none"> -BB Back-to-Back Carrier -DP Double Plate Carrier -UR Urinal Carrier -VP Vandal-Proof Trim -WC Water Cooler Carrier -WCBL Water Cooler Bi-Level Carrier -10 Hardware for Thicker Walls -11 Cast Iron Adjustable Extension through 12" Length, Specify 6", 9" or 12" on Order -45 Threaded High Left-Hand Auxiliary Vent -46 Threaded High Right-Hand Auxiliary Vent -60 Valve Plate for Attaching to Upright -66 Split Header for Stainless Steel Arms
LIST PRICE																																			
17560	17560-BB	17560-UR 17560-WC	17560-WCBL																																
\$365.00	\$509.00	\$365.00	\$723.00																																
	17560	17560-BB																																	
-BB	\$144.00	ABOVE																																	
-UR**	0.00	----																																	
-WC**	0.00	----																																	
-WCBL**	358.00	----																																	
-10*	21.00	\$42.00																																	
-60	64.00	128.00																																	
	<p align="center">WALL-MOUNT HANGER PLATE TYPE</p> <table border="1"> <thead> <tr> <th colspan="3">LIST PRICE</th> </tr> <tr> <th>17590</th> <th>17590-DP</th> <th>17590-UR</th> </tr> </thead> <tbody> <tr> <td>\$90.00</td> <td>\$111.00</td> <td>\$90.00</td> </tr> </tbody> </table> <p>ADD FOR OPTIONS:</p> <table border="1"> <tbody> <tr> <td>-DP.....</td> <td>\$21.00</td> <td>-10*.....</td> <td>\$21.00</td> </tr> <tr> <td>-UR.....</td> <td>0.00</td> <td></td> <td></td> </tr> </tbody> </table> <p>* Hardware for Walls over 7" for 17590 or 4" for 17590-DP and 17590 -UR-DP, Specify Wall Thickness, Price Per Inch</p>	LIST PRICE			17590	17590-DP	17590-UR	\$90.00	\$111.00	\$90.00	-DP.....	\$21.00	-10*.....	\$21.00	-UR.....	0.00																			
LIST PRICE																																			
17590	17590-DP	17590-UR																																	
\$90.00	\$111.00	\$90.00																																	
-DP.....	\$21.00	-10*.....	\$21.00																																
-UR.....	0.00																																		
	<p align="center">FLOOR-MOUNT HEAVY-DUTY TYPE</p> <table border="1"> <thead> <tr> <th colspan="3">LIST PRICE</th> </tr> <tr> <th>TYPE NO.</th> <th>17720</th> <th>\$1,109.00</th> </tr> </thead> <tbody> <tr> <td colspan="3">ADD FOR OPTIONS:</td> </tr> <tr> <td>-VP.....</td> <td>\$57.00</td> <td>-66.....</td> <td>P.O.A. •</td> </tr> <tr> <td>-10*.....</td> <td>43.00</td> <td></td> <td></td> </tr> </tbody> </table> <p>* Hardware for Walls over 4", Specify Wall Thickness, Price Per Inch • Price on Application</p>	LIST PRICE			TYPE NO.	17720	\$1,109.00	ADD FOR OPTIONS:			-VP.....	\$57.00	-66.....	P.O.A. •	-10*.....	43.00																			
LIST PRICE																																			
TYPE NO.	17720	\$1,109.00																																	
ADD FOR OPTIONS:																																			
-VP.....	\$57.00	-66.....	P.O.A. •																																
-10*.....	43.00																																		
	<p align="center">FLOOR-MOUNT WITH ADJUSTABLE COUPLING</p> <table border="1"> <thead> <tr> <th colspan="3">LIST PRICE</th> </tr> <tr> <th>TYPE NO.</th> <th>17730</th> <th>\$522.00</th> </tr> </thead> <tbody> <tr> <td colspan="3">ADD FOR OPTIONS:</td> </tr> <tr> <td>-VP.....</td> <td>\$57.00</td> <td>-60.....</td> <td>\$64.00</td> </tr> <tr> <td>-11.....</td> <td>0.00</td> <td></td> <td></td> </tr> </tbody> </table>	LIST PRICE			TYPE NO.	17730	\$522.00	ADD FOR OPTIONS:			-VP.....	\$57.00	-60.....	\$64.00	-11.....	0.00																			
LIST PRICE																																			
TYPE NO.	17730	\$522.00																																	
ADD FOR OPTIONS:																																			
-VP.....	\$57.00	-60.....	\$64.00																																
-11.....	0.00																																		
	<p align="center">FLOOR-MOUNT WITH FITTING</p> <table border="1"> <thead> <tr> <th colspan="3">LIST PRICE</th> </tr> <tr> <th>TYPE NO.</th> <th>17735</th> <th>\$865.00</th> </tr> </thead> <tbody> <tr> <td colspan="3">ADD FOR OPTIONS:</td> </tr> <tr> <td>-VP.....</td> <td>\$57.00</td> <td>-45.....</td> <td>\$159.00</td> </tr> <tr> <td>-10*.....</td> <td>0.00</td> <td>-46.....</td> <td>159.00</td> </tr> </tbody> </table> <p>* Hardware for Walls over 5-3/8", Specify Wall Thickness, Price Per Inch NOTE: Other Fittings Available on Request. Contact your Josam Representative.</p>	LIST PRICE			TYPE NO.	17735	\$865.00	ADD FOR OPTIONS:			-VP.....	\$57.00	-45.....	\$159.00	-10*.....	0.00	-46.....	159.00																	
LIST PRICE																																			
TYPE NO.	17735	\$865.00																																	
ADD FOR OPTIONS:																																			
-VP.....	\$57.00	-45.....	\$159.00																																
-10*.....	0.00	-46.....	159.00																																

	15" DOME, LARGE SUMP					
	LIST PRICE					
	PIPE SIZE	21500	21500-AE	21500-16	21500-AE-16	
	2", 3", 4"	\$326.00	\$652.00	\$519.00	\$845.00	
	5", 6"	466.00	792.00	659.00	985.00	
	8"	605.00	931.00	N/A	N/A	
	10"	954.00	1,280.00	N/A	N/A	
ADD FOR OPTIONS:						
	-AE	\$326.00	-6	\$606.00	-23	\$382.00
	-AER	150.00	-10**	305.00	-26	113.00
	-IRMA	361.00	-10-20**	482.00	-33	231.00
	-CR	192.00	-16	193.00	-VP	57.00
	-1	112.00	-17	105.00	-66	170.00
	-1C*	45.00	-19	361.00	-T	36.00
	-2	125.00	-20	441.00	-X	0.00
	-3	237.00	-21	190.00	-Y	0.00
	-3C	170.00	-22	96.00	-Z	0.00
	-4	86.00				
* Minimum Deck Opening 16.5" Dia.						
** Specify Height, Price Each 4" or Fraction						
◇ -16 and -17 cannot be furnished together						

	12" BEEHIVE DOME, MEDIUM SUMP					
	LIST PRICE					
	PIPE SIZE	2"-6"				
		\$288.00				
ADD FOR OPTIONS:						
	-1	\$69.00	-10-20**	\$80.00	-VP	\$52.00
	-1C*	45.00	-17	87.00	-66	73.00
	-2	118.00	-19	288.00	-T	36.00
	-3	187.00	-20	180.00	-X	0.00
	-3C	163.00	-21	73.00	-Z	0.00
	-10**	40.00	-23	187.00		
* Minimum Deck Opening 13.75" Dia.						
** Specify Height, Price Per Inch						

	9" HIGH DOME, SMALL SUMP					
	LIST PRICE					
	PIPE SIZE	2", 3", 4"				
		\$243.00				
ADD FOR OPTIONS:						
	-TSO	\$85.00	-3C	\$156.00	-23	153.00
	-1	69.00	-10**	40.00	-VP	\$52.00
	-1C*	38.00	-10-20**	80.00	-T	36.00
	-2	118.00	-17	87.00	-X	0.00
	-3	187.00	-20	92.00	-Y	0.00
			-21	37.00	-Z	0.00
◇ Cannot be used with Drain Receiver						
* Minimum Deck Opening 10.75" Dia.						
** Specify Height, Price Per Inch						

	COMBINATION DRAIN/OVERFLOW, SMALL SUMP					
	LIST PRICE					
	PIPE SIZE	2", 3", 4"				
		\$335.00				
ADD FOR OPTIONS:						
	-1	\$158.00	-23	\$153.00	-VP	\$52.00
	-10*	80.00	-28	0.00	-IRMA	425.00
	-20	184.00	-33	129.00	-Z	0.00
* Specify Height, Price Per Inch						

	COMBINATION DRAIN/OVERFLOW, MEDIUM SUMP					
	LIST PRICE					
	PIPE SIZE	2"-6"				
		\$895.00				
ADD FOR OPTIONS:						
	-10*	\$80.00	-33	\$430.00	-T	\$72.00
	-20	360.00	-VP	104.00	-X	0.00
	-23	374.00	-IRMA	576.00	-Z	0.00
* Specify Height, Price Per Inch						

	COMBINATION DRAIN/OVERFLOW, LARGE SUMP					
	LIST PRICE					
	PIPE SIZE	2", 3", 4"	5", 6"	8"		
		\$1,146.00	\$1,425.00	\$1,704.00		
ADD FOR OPTIONS:						
	-10*	\$608.00	-VP	\$114.00	-Y	\$0.00
	-20	882.00	-IRMA	726.00	-Z	0.00
	-23	764.00	-T	72.00		
	-33	462.00	-X	0.00		
* Specify Height, Price Each 4" or Fraction						

	14" PROMENADE TOP, LARGE SUMP					
	LIST PRICE					
	PIPE SIZE	23500	23500-AE	23500-6	23500-IRMA	
	2", 3", 4"	\$554.00	\$880.00	\$1,160.00	\$915.00	
	5", 6"	685.00	1,011.00	1,291.00	1,046.00	
	8"	813.00	1,139.00	N/A	1,174.00	
	10"	1,086.00	1,412.00	N/A	1,447.00	
ADD FOR OPTIONS:						
	-AE	\$326.00	-6	\$606.00	-51	\$376.00
	-IRMA	361.00	-10**	305.00	-PG	358.00
	-CR	192.00	-10-20**	482.00	-VP	67.00
	-1	112.00	-18	273.00	-66	170.00
	-1C*	45.00	-20	409.00	-T	36.00
	-2	125.00	-36	283.00	-X	0.00
	-3	237.00	-37-50	746.00	-Y	0.00
	-3C	170.00	-37-51	657.00	-Z	0.00
	-4	86.00	-50	461.00		
* Minimum Deck Opening 16.5" Dia.						
** Specify Height, Price Each 4" or Fraction						













Roof Drain OPTION DESCRIPTIONS







- AE LEVELEZE® Adjustable Extension
- AER Adjustable Extension using Threaded Rods and Hardware
- CR Clamping Drain Receiver
- IRMA Perforated Stainless Steel Extension
- PG Parking Grate
- VP Vandal-Proof Dome or Grate
- 1 Deck Clamp Assembly
- 1C Drain Receiver Clips
- 2 Drain Receiver
- 3 Deck Clamp Assembly and Drain Receiver
- 3C Drain Receiver and Drain Receiver Clips
- 4 Secondary Flashing Clamp (use with -AE Only)
- 6 Extra Wide Flange Drain Body (2" through 6", -X Only)
- 10 Fixed Extended Collar, Cast Iron
- 10-20 Fixed Extended Collar, Galvanized
- 16 Internal Water Guard 2-6" Outlets Only
- 17 2" High Solid Clamping Collar
- 18 Extra Deep Sump
- 19 Clamp Collar w/Perforated SS Gravel Guard
- 20 Galvanized Cast Iron Parts
- 21 Galvanized Cast Iron Dome Only
- 22 Cast Iron Dome
- 23 Rough Bronze Dome
- 26 Aluminum Dome
- 28 Cast Iron Dome for Overflow Drain
- 33 Stainless Mesh Screen-Covered Dome
- 36 Ductile Iron Grate (Cast Iron Top Only)
- 37-50 HD Ductile Iron Undergrate Laminated Top, Satin Finish Nikaloy
- 37-51 HD Ductile Iron Undergrate Laminated Top, Satin Finish Bronze
- 50 C.I. Undergrate Laminated Top, Satin Finish Nikaloy
- 51 C.I. Undergrate Laminated Top, Satin Finish Bronze











- ### Outlets
- 66 No-Hub Side Outlet, 2"-6"
 - T Threaded Outlet
 - TSO Threaded Side Outlet
 - X Inside Caulk Outlet
 - Y Hub Outlet w/Gasket, 2"-4"
 - Z No-Hub Spigot Outlet

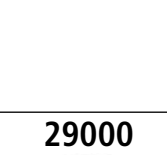



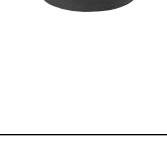

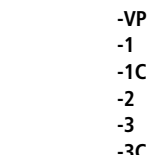

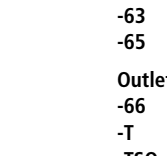
ROOF DRAINS















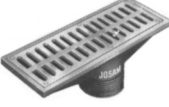



 <p>23510</p>	<p>15" EXTRA HEAVY-DUTY PARKING GRATE, LARGE SUMP</p> <table border="1"> <thead> <tr> <th colspan="4">LIST PRICE</th> </tr> <tr> <th>PIPE SIZE</th> <th>2", 3", 4"</th> <th>5", 6"</th> <th>8"</th> </tr> </thead> <tbody> <tr> <td></td> <td>\$719.00</td> <td>\$851.00</td> <td>\$1,016.00</td> </tr> </tbody> </table> <p>ADD FOR OPTIONS:</p> <table> <tr> <td>-CR</td> <td>\$192.00</td> <td>-10**</td> <td>\$326.00</td> <td>-VP</td> <td>\$66.00</td> </tr> <tr> <td>-1</td> <td>112.00</td> <td>-10-20**</td> <td>460.00</td> <td>-T</td> <td>36.00</td> </tr> <tr> <td>-1C*</td> <td>45.00</td> <td>-20</td> <td>409.00</td> <td>-X</td> <td>0.00</td> </tr> <tr> <td>-2</td> <td>125.00</td> <td>-36</td> <td>282.00</td> <td>-Y</td> <td>0.00</td> </tr> <tr> <td>-3</td> <td>237.00</td> <td>-50</td> <td>1,184.00</td> <td>-Z</td> <td>0.00</td> </tr> <tr> <td>-3C</td> <td>170.00</td> <td>-51</td> <td>1,063.00</td> <td></td> <td></td> </tr> </table> <p>* Minimum Deck Opening 16.5" Dia. ** Specify Height, Price Each 4" or Fraction</p>	LIST PRICE				PIPE SIZE	2", 3", 4"	5", 6"	8"		\$719.00	\$851.00	\$1,016.00	-CR	\$192.00	-10**	\$326.00	-VP	\$66.00	-1	112.00	-10-20**	460.00	-T	36.00	-1C*	45.00	-20	409.00	-X	0.00	-2	125.00	-36	282.00	-Y	0.00	-3	237.00	-50	1,184.00	-Z	0.00	-3C	170.00	-51	1,063.00			 <p>24030</p>	<p>13" SUPER-FLO® TOP, MEDIUM SUMP COMPOSITION DECK FLANGE</p> <table border="1"> <thead> <tr> <th colspan="3">LIST PRICE</th> </tr> <tr> <th>PIPE SIZE</th> <th>4", 5", 6", 8"</th> <th></th> </tr> </thead> <tbody> <tr> <td></td> <td></td> <td>\$819.00</td> </tr> </tbody> </table> <p>ADD FOR OPTIONS:</p> <table> <tr> <td>-1</td> <td>\$103.00</td> <td>-31</td> <td>\$52.00</td> <td>-VP</td> <td>\$68.00</td> </tr> <tr> <td>-20</td> <td>367.00</td> <td>-36</td> <td>121.00</td> <td>-X</td> <td>0.00</td> </tr> <tr> <td>-29</td> <td>111.00</td> <td>-50</td> <td>332.00</td> <td></td> <td></td> </tr> <tr> <td>-29-20</td> <td>203.00</td> <td>-51</td> <td>302.00</td> <td></td> <td></td> </tr> </table>	LIST PRICE			PIPE SIZE	4", 5", 6", 8"				\$819.00	-1	\$103.00	-31	\$52.00	-VP	\$68.00	-20	367.00	-36	121.00	-X	0.00	-29	111.00	-50	332.00			-29-20	203.00	-51	302.00		
LIST PRICE																																																																																				
PIPE SIZE	2", 3", 4"	5", 6"	8"																																																																																	
	\$719.00	\$851.00	\$1,016.00																																																																																	
-CR	\$192.00	-10**	\$326.00	-VP	\$66.00																																																																															
-1	112.00	-10-20**	460.00	-T	36.00																																																																															
-1C*	45.00	-20	409.00	-X	0.00																																																																															
-2	125.00	-36	282.00	-Y	0.00																																																																															
-3	237.00	-50	1,184.00	-Z	0.00																																																																															
-3C	170.00	-51	1,063.00																																																																																	
LIST PRICE																																																																																				
PIPE SIZE	4", 5", 6", 8"																																																																																			
		\$819.00																																																																																		
-1	\$103.00	-31	\$52.00	-VP	\$68.00																																																																															
-20	367.00	-36	121.00	-X	0.00																																																																															
-29	111.00	-50	332.00																																																																																	
-29-20	203.00	-51	302.00																																																																																	
 <p>23710</p>	<p>11" PROMENADE TOP, MEDIUM SUMP</p> <table border="1"> <thead> <tr> <th colspan="3">LIST PRICE</th> </tr> <tr> <th>PIPE SIZE</th> <th>2"-6"</th> <th></th> </tr> </thead> <tbody> <tr> <td></td> <td></td> <td>\$496.00</td> </tr> </tbody> </table> <p>ADD FOR OPTIONS:</p> <table> <tr> <td>-1</td> <td>\$69.00</td> <td>-12**</td> <td>\$40.00</td> <td>-66</td> <td>\$71.00</td> </tr> <tr> <td>-1C*</td> <td>45.00</td> <td>-20</td> <td>230.00</td> <td>-T</td> <td>36.00</td> </tr> <tr> <td>-2</td> <td>115.00</td> <td>-50</td> <td>339.00</td> <td>-X</td> <td>0.00</td> </tr> <tr> <td>-3</td> <td>184.00</td> <td>-51</td> <td>295.00</td> <td>-Z</td> <td>0.00</td> </tr> <tr> <td>-3C</td> <td>160.00</td> <td>-VP</td> <td>66.00</td> <td></td> <td></td> </tr> </table> <p>* Minimum Deck Opening 13.75" Dia. ** Specify Height, Price Per Inch</p>	LIST PRICE			PIPE SIZE	2"-6"				\$496.00	-1	\$69.00	-12**	\$40.00	-66	\$71.00	-1C*	45.00	-20	230.00	-T	36.00	-2	115.00	-50	339.00	-X	0.00	-3	184.00	-51	295.00	-Z	0.00	-3C	160.00	-VP	66.00			 <p>24040</p>	<p>9" SUPER-FLO® TOP, MEDIUM SUMP COMPOSITION DECK FLANGE</p> <table border="1"> <thead> <tr> <th colspan="3">LIST PRICE</th> </tr> <tr> <th>PIPE SIZE</th> <th>2", 3", 4"</th> <th></th> </tr> </thead> <tbody> <tr> <td></td> <td></td> <td>\$463.00</td> </tr> </tbody> </table> <p>ADD FOR OPTIONS:</p> <table> <tr> <td>-1</td> <td>\$69.00</td> <td>-31</td> <td>\$52.00</td> <td>-51</td> <td>\$190.00</td> </tr> <tr> <td>-20</td> <td>276.00</td> <td>-36</td> <td>96.00</td> <td>-VP</td> <td>68.00</td> </tr> <tr> <td>-29</td> <td>63.00</td> <td>-38 Deduct</td> <td>41.00</td> <td>-X</td> <td>0.00</td> </tr> <tr> <td>-29-20</td> <td>95.00</td> <td>-50</td> <td>231.00</td> <td></td> <td></td> </tr> </table>	LIST PRICE			PIPE SIZE	2", 3", 4"				\$463.00	-1	\$69.00	-31	\$52.00	-51	\$190.00	-20	276.00	-36	96.00	-VP	68.00	-29	63.00	-38 Deduct	41.00	-X	0.00	-29-20	95.00	-50	231.00											
LIST PRICE																																																																																				
PIPE SIZE	2"-6"																																																																																			
		\$496.00																																																																																		
-1	\$69.00	-12**	\$40.00	-66	\$71.00																																																																															
-1C*	45.00	-20	230.00	-T	36.00																																																																															
-2	115.00	-50	339.00	-X	0.00																																																																															
-3	184.00	-51	295.00	-Z	0.00																																																																															
-3C	160.00	-VP	66.00																																																																																	
LIST PRICE																																																																																				
PIPE SIZE	2", 3", 4"																																																																																			
		\$463.00																																																																																		
-1	\$69.00	-31	\$52.00	-51	\$190.00																																																																															
-20	276.00	-36	96.00	-VP	68.00																																																																															
-29	63.00	-38 Deduct	41.00	-X	0.00																																																																															
-29-20	95.00	-50	231.00																																																																																	
 <p>23730</p>	<p>9" PROMENADE TOP, SMALL SUMP</p> <table border="1"> <thead> <tr> <th colspan="3">LIST PRICE</th> </tr> <tr> <th>PIPE SIZE</th> <th>2", 3", 4"</th> <th></th> </tr> </thead> <tbody> <tr> <td></td> <td></td> <td>\$377.00</td> </tr> </tbody> </table> <p>ADD FOR OPTIONS:</p> <table> <tr> <td>-TSO ◊</td> <td>\$85.00</td> <td>-12**</td> <td>\$40.00</td> <td>-T</td> <td>\$36.00</td> </tr> <tr> <td>-1</td> <td>69.00</td> <td>-12-20**</td> <td>80.00</td> <td>-X</td> <td>0.00</td> </tr> <tr> <td>-1C*</td> <td>38.00</td> <td>-20</td> <td>123.00</td> <td>-Y</td> <td>0.00</td> </tr> <tr> <td>-2</td> <td>115.00</td> <td>-50</td> <td>197.00</td> <td>-Z</td> <td>0.00</td> </tr> <tr> <td>-3</td> <td>184.00</td> <td>-51</td> <td>176.00</td> <td></td> <td></td> </tr> <tr> <td>-3C</td> <td>153.00</td> <td>-VP</td> <td>66.00</td> <td></td> <td></td> </tr> </table> <p>◊ Cannot be used with Drain Receiver * Minimum Deck Opening 10.25" Dia. ** Specify Height, Price Per Inch</p>	LIST PRICE			PIPE SIZE	2", 3", 4"				\$377.00	-TSO ◊	\$85.00	-12**	\$40.00	-T	\$36.00	-1	69.00	-12-20**	80.00	-X	0.00	-1C*	38.00	-20	123.00	-Y	0.00	-2	115.00	-50	197.00	-Z	0.00	-3	184.00	-51	176.00			-3C	153.00	-VP	66.00			 <p>24050</p>	<p>GARAGE DRAIN, 13" SPECIAL-DUTY TOP, WIDE FLANGE</p> <table border="1"> <thead> <tr> <th colspan="3">LIST PRICE</th> </tr> <tr> <th>PIPE SIZE</th> <th>5", 6"</th> <th>8"</th> </tr> </thead> <tbody> <tr> <td></td> <td>\$1,164.00</td> <td>\$1,301.00</td> </tr> </tbody> </table> <p>ADD FOR OPTIONS:</p> <table> <tr> <td>-1</td> <td>\$103.00</td> <td>-29-20</td> <td>\$205.00</td> <td>-51</td> <td>\$496.00</td> </tr> <tr> <td>-12*</td> <td>40.00</td> <td>-31</td> <td>52.00</td> <td>-VP</td> <td>68.00</td> </tr> <tr> <td>-20</td> <td>501.00</td> <td>-36</td> <td>121.00</td> <td>-X</td> <td>0.00</td> </tr> <tr> <td>-29</td> <td>95.00</td> <td>-50</td> <td>604.00</td> <td></td> <td></td> </tr> </table> <p>*Specify Height, Price Per Inch</p>	LIST PRICE			PIPE SIZE	5", 6"	8"		\$1,164.00	\$1,301.00	-1	\$103.00	-29-20	\$205.00	-51	\$496.00	-12*	40.00	-31	52.00	-VP	68.00	-20	501.00	-36	121.00	-X	0.00	-29	95.00	-50	604.00					
LIST PRICE																																																																																				
PIPE SIZE	2", 3", 4"																																																																																			
		\$377.00																																																																																		
-TSO ◊	\$85.00	-12**	\$40.00	-T	\$36.00																																																																															
-1	69.00	-12-20**	80.00	-X	0.00																																																																															
-1C*	38.00	-20	123.00	-Y	0.00																																																																															
-2	115.00	-50	197.00	-Z	0.00																																																																															
-3	184.00	-51	176.00																																																																																	
-3C	153.00	-VP	66.00																																																																																	
LIST PRICE																																																																																				
PIPE SIZE	5", 6"	8"																																																																																		
	\$1,164.00	\$1,301.00																																																																																		
-1	\$103.00	-29-20	\$205.00	-51	\$496.00																																																																															
-12*	40.00	-31	52.00	-VP	68.00																																																																															
-20	501.00	-36	121.00	-X	0.00																																																																															
-29	95.00	-50	604.00																																																																																	
 <p>23740</p>	<p>8" HEAVY-DUTY TOP, MEDIUM SUMP</p> <table border="1"> <thead> <tr> <th colspan="3">LIST PRICE</th> </tr> <tr> <th>PIPE SIZE</th> <th>2", 3", 4"</th> <th></th> </tr> </thead> <tbody> <tr> <td></td> <td></td> <td>\$959.00</td> </tr> </tbody> </table> <p>ADD FOR OPTIONS:</p> <table> <tr> <td>-TSO ◊</td> <td>\$85.00</td> <td>-3</td> <td>184.00</td> <td>-51 Deduct</td> <td>46.00</td> </tr> <tr> <td>-1</td> <td>69.00</td> <td>-3C</td> <td>\$153.00</td> <td>-VP</td> <td>\$66.00</td> </tr> <tr> <td>-1C*</td> <td>38.00</td> <td>-12**</td> <td>48.00</td> <td>-T</td> <td>36.00</td> </tr> <tr> <td>-2</td> <td>115.00</td> <td>-12-20**</td> <td>74.00</td> <td>-X</td> <td>0.00</td> </tr> <tr> <td></td> <td></td> <td>-20</td> <td>131.00</td> <td>-Y</td> <td>0.00</td> </tr> </table> <p>◊ Cannot be used with Drain Receiver * Minimum Deck Opening 10.25" Dia. ** Specify Height, Price Per Inch</p>	LIST PRICE			PIPE SIZE	2", 3", 4"				\$959.00	-TSO ◊	\$85.00	-3	184.00	-51 Deduct	46.00	-1	69.00	-3C	\$153.00	-VP	\$66.00	-1C*	38.00	-12**	48.00	-T	36.00	-2	115.00	-12-20**	74.00	-X	0.00			-20	131.00	-Y	0.00	 <p>24060</p>	<p>15" SPECIAL-DUTY TOP COMPOSITION DECK FLANGE</p> <table border="1"> <thead> <tr> <th colspan="3">LIST PRICE</th> </tr> <tr> <th>PIPE SIZE</th> <th>4", 6"</th> <th>8"</th> </tr> </thead> <tbody> <tr> <td></td> <td>\$1,452.00</td> <td>\$1,628.00</td> </tr> </tbody> </table> <p>ADD FOR OPTIONS:</p> <table> <tr> <td>-1</td> <td>\$111.00</td> <td>-29-20</td> <td>\$236.00</td> <td>-51</td> <td>\$360.00</td> </tr> <tr> <td>-20</td> <td>504.00</td> <td>-31</td> <td>121.00</td> <td>-VP</td> <td>68.00</td> </tr> <tr> <td>-29</td> <td>143.00</td> <td>-50</td> <td>416.00</td> <td>-X</td> <td>0.00</td> </tr> </table>	LIST PRICE			PIPE SIZE	4", 6"	8"		\$1,452.00	\$1,628.00	-1	\$111.00	-29-20	\$236.00	-51	\$360.00	-20	504.00	-31	121.00	-VP	68.00	-29	143.00	-50	416.00	-X	0.00															
LIST PRICE																																																																																				
PIPE SIZE	2", 3", 4"																																																																																			
		\$959.00																																																																																		
-TSO ◊	\$85.00	-3	184.00	-51 Deduct	46.00																																																																															
-1	69.00	-3C	\$153.00	-VP	\$66.00																																																																															
-1C*	38.00	-12**	48.00	-T	36.00																																																																															
-2	115.00	-12-20**	74.00	-X	0.00																																																																															
		-20	131.00	-Y	0.00																																																																															
LIST PRICE																																																																																				
PIPE SIZE	4", 6"	8"																																																																																		
	\$1,452.00	\$1,628.00																																																																																		
-1	\$111.00	-29-20	\$236.00	-51	\$360.00																																																																															
-20	504.00	-31	121.00	-VP	68.00																																																																															
-29	143.00	-50	416.00	-X	0.00																																																																															
 <p>24020</p>	<p>9" SUPER-FLO® TOP, MEDIUM SUMP COMPOSITION DECK FLANGE</p> <table border="1"> <thead> <tr> <th colspan="3">LIST PRICE</th> </tr> <tr> <th>PIPE SIZE</th> <th>2", 3", 4"</th> <th></th> </tr> </thead> <tbody> <tr> <td></td> <td></td> <td>\$372.00</td> </tr> </tbody> </table> <p>ADD FOR OPTIONS:</p> <table> <tr> <td>-1</td> <td>\$69.00</td> <td>-31</td> <td>\$52.00</td> <td>-51</td> <td>\$148.00</td> </tr> <tr> <td>-20</td> <td>314.00</td> <td>-36</td> <td>97.00</td> <td>-VP</td> <td>68.00</td> </tr> <tr> <td>-29</td> <td>30.00</td> <td>-38 Deduct</td> <td>41.00</td> <td>-X</td> <td>0.00</td> </tr> <tr> <td>-29-20</td> <td>66.00</td> <td>-50</td> <td>151.00</td> <td></td> <td></td> </tr> </table>	LIST PRICE			PIPE SIZE	2", 3", 4"				\$372.00	-1	\$69.00	-31	\$52.00	-51	\$148.00	-20	314.00	-36	97.00	-VP	68.00	-29	30.00	-38 Deduct	41.00	-X	0.00	-29-20	66.00	-50	151.00			 <p>24200</p>	<p>16" PROMENADE TOP, ALL LEVEL BONDING FLANGE</p> <table border="1"> <thead> <tr> <th colspan="3">LIST PRICE</th> </tr> <tr> <th>PIPE SIZE</th> <th>2"-6"</th> <th></th> </tr> </thead> <tbody> <tr> <td></td> <td></td> <td>\$2,218.00</td> </tr> </tbody> </table> <p>ADD FOR OPTIONS:</p> <table> <tr> <td>-1</td> <td>\$111.00</td> <td>-50</td> <td>\$934.00</td> <td>-60-50</td> <td>\$1,256.00</td> </tr> <tr> <td>-20</td> <td>441.00</td> <td>-51</td> <td>844.00</td> <td>-60-51</td> <td>1,131.00</td> </tr> <tr> <td>-VP</td> <td>68.00</td> <td>-60</td> <td>102.00</td> <td>-X</td> <td>0.00</td> </tr> </table>	LIST PRICE			PIPE SIZE	2"-6"				\$2,218.00	-1	\$111.00	-50	\$934.00	-60-50	\$1,256.00	-20	441.00	-51	844.00	-60-51	1,131.00	-VP	68.00	-60	102.00	-X	0.00																					
LIST PRICE																																																																																				
PIPE SIZE	2", 3", 4"																																																																																			
		\$372.00																																																																																		
-1	\$69.00	-31	\$52.00	-51	\$148.00																																																																															
-20	314.00	-36	97.00	-VP	68.00																																																																															
-29	30.00	-38 Deduct	41.00	-X	0.00																																																																															
-29-20	66.00	-50	151.00																																																																																	
LIST PRICE																																																																																				
PIPE SIZE	2"-6"																																																																																			
		\$2,218.00																																																																																		
-1	\$111.00	-50	\$934.00	-60-50	\$1,256.00																																																																															
-20	441.00	-51	844.00	-60-51	1,131.00																																																																															
-VP	68.00	-60	102.00	-X	0.00																																																																															
 <p>24500</p>	<p>SILL TYPE 4" DOME, SHALLOW SUMP</p> <table border="1"> <thead> <tr> <th colspan="4">LIST PRICE</th> </tr> <tr> <th>PIPE SIZE</th> <th>24500</th> <th>24500-45</th> <th>24500-90</th> </tr> </thead> <tbody> <tr> <td>2", 3"</td> <td>\$192.00</td> <td>\$244.00</td> <td>\$244.00</td> </tr> <tr> <td>4"</td> <td>279.00</td> <td>331.00</td> <td>331.00</td> </tr> </tbody> </table> <p>ADD FOR OPTIONS:</p> <table> <tr> <td>-45</td> <td>\$52.00</td> <td>-27</td> <td>\$37.00</td> <td>-51</td> <td>\$55.00</td> </tr> <tr> <td>-90</td> <td>52.00</td> <td>-33</td> <td>108.00</td> <td>-VP</td> <td>25.00</td> </tr> <tr> <td>-20</td> <td>74.00</td> <td>-35</td> <td>0.00</td> <td>-T</td> <td>0.00</td> </tr> <tr> <td>-24</td> <td>40.00</td> <td>-50</td> <td>94.00</td> <td></td> <td></td> </tr> </table>	LIST PRICE				PIPE SIZE	24500	24500-45	24500-90	2", 3"	\$192.00	\$244.00	\$244.00	4"	279.00	331.00	331.00	-45	\$52.00	-27	\$37.00	-51	\$55.00	-90	52.00	-33	108.00	-VP	25.00	-20	74.00	-35	0.00	-T	0.00	-24	40.00	-50	94.00																																													
LIST PRICE																																																																																				
PIPE SIZE	24500	24500-45	24500-90																																																																																	
2", 3"	\$192.00	\$244.00	\$244.00																																																																																	
4"	279.00	331.00	331.00																																																																																	
-45	\$52.00	-27	\$37.00	-51	\$55.00																																																																															
-90	52.00	-33	108.00	-VP	25.00																																																																															
-20	74.00	-35	0.00	-T	0.00																																																																															
-24	40.00	-50	94.00																																																																																	

 <p>24700</p>	<p align="center">PARAPET TYPE, SLOPING GRATE</p> <table border="1"> <thead> <tr> <th colspan="3">LIST PRICE</th> </tr> <tr> <th>PIPE SIZE</th> <th>2", 3", 4"</th> <th>5", 6"</th> </tr> </thead> <tbody> <tr> <td></td> <td>\$482.00</td> <td>\$875.00</td> </tr> </tbody> </table> <p>ADD FOR OPTIONS:</p> <table> <tr> <td>-45</td> <td>\$0.00</td> <td>-50</td> <td>\$269.00</td> </tr> <tr> <td>-20 (2"-4")</td> <td>110.00</td> <td>-51</td> <td>150.00</td> </tr> <tr> <td>-20 (5"-6")</td> <td>220.00</td> <td>-61 (2"-4")</td> <td>155.00</td> </tr> <tr> <td>-22 (2"-4")</td> <td>Deduct 196.00</td> <td>-61 (5"-6")</td> <td>260.00</td> </tr> <tr> <td>-22 (5"-6")</td> <td>Deduct 196.00</td> <td>-61-20 (2"-4")</td> <td>222.00</td> </tr> <tr> <td>-24</td> <td>205.00</td> <td>-61-20 (5"-6")</td> <td>289.00</td> </tr> </table>	LIST PRICE			PIPE SIZE	2", 3", 4"	5", 6"		\$482.00	\$875.00	-45	\$0.00	-50	\$269.00	-20 (2"-4")	110.00	-51	150.00	-20 (5"-6")	220.00	-61 (2"-4")	155.00	-22 (2"-4")	Deduct 196.00	-61 (5"-6")	260.00	-22 (5"-6")	Deduct 196.00	-61-20 (2"-4")	222.00	-24	205.00	-61-20 (5"-6")	289.00	 <p>25500</p>	<p align="center">FLO-SEPTOR®, LARGE SUMP</p> <table border="1"> <thead> <tr> <th colspan="3">LIST PRICE</th> </tr> <tr> <th>PIPE SIZE</th> <th>2", 3", 4"</th> <th>5", 6"</th> </tr> </thead> <tbody> <tr> <td></td> <td>\$431.00</td> <td>\$578.00</td> </tr> </tbody> </table> <p>ADD FOR OPTIONS:</p> <table> <tr> <td>-CR</td> <td>\$131.00</td> <td>-20</td> <td>\$409.00</td> <td>-Y</td> <td>\$0.00</td> </tr> <tr> <td>-1</td> <td>112.00</td> <td>-66</td> <td>170.00</td> <td>-Z</td> <td>0.00</td> </tr> <tr> <td>-2</td> <td>125.00</td> <td>-T</td> <td>36.00</td> <td></td> <td></td> </tr> <tr> <td>-3</td> <td>237.00</td> <td>-X</td> <td>0.00</td> <td></td> <td></td> </tr> </table>	LIST PRICE			PIPE SIZE	2", 3", 4"	5", 6"		\$431.00	\$578.00	-CR	\$131.00	-20	\$409.00	-Y	\$0.00	-1	112.00	-66	170.00	-Z	0.00	-2	125.00	-T	36.00			-3	237.00	-X	0.00		
LIST PRICE																																																																					
PIPE SIZE	2", 3", 4"	5", 6"																																																																			
	\$482.00	\$875.00																																																																			
-45	\$0.00	-50	\$269.00																																																																		
-20 (2"-4")	110.00	-51	150.00																																																																		
-20 (5"-6")	220.00	-61 (2"-4")	155.00																																																																		
-22 (2"-4")	Deduct 196.00	-61 (5"-6")	260.00																																																																		
-22 (5"-6")	Deduct 196.00	-61-20 (2"-4")	222.00																																																																		
-24	205.00	-61-20 (5"-6")	289.00																																																																		
LIST PRICE																																																																					
PIPE SIZE	2", 3", 4"	5", 6"																																																																			
	\$431.00	\$578.00																																																																			
-CR	\$131.00	-20	\$409.00	-Y	\$0.00																																																																
-1	112.00	-66	170.00	-Z	0.00																																																																
-2	125.00	-T	36.00																																																																		
-3	237.00	-X	0.00																																																																		
 <p>24720</p>	<p align="center">PARAPET TYPE, ANGLE GRATE</p> <table border="1"> <thead> <tr> <th colspan="3">LIST PRICE</th> </tr> <tr> <th>PIPE SIZE</th> <th>24720</th> <th>24720-45</th> </tr> </thead> <tbody> <tr> <td>2", 3", 4"</td> <td>\$305.00</td> <td>\$305.00</td> </tr> <tr> <td>5", 6"</td> <td>579.00</td> <td>579.00</td> </tr> </tbody> </table> <p>ADD FOR OPTIONS:</p> <table> <tr> <td>-45</td> <td>\$0.00</td> <td>-50</td> <td>\$466.00</td> </tr> <tr> <td>-20 (2"-4")</td> <td>110.00</td> <td>-51</td> <td>347.00</td> </tr> <tr> <td>-20 (5"-6")</td> <td>220.00</td> <td>-61 (2"-4")</td> <td>155.00</td> </tr> <tr> <td>-23 (2"-4")</td> <td>197.00</td> <td>-61 (5"-6")</td> <td>260.00</td> </tr> <tr> <td>-23 (5"-6")</td> <td>321.00</td> <td>-61-20 (2"-4")</td> <td>222.00</td> </tr> <tr> <td>-24 (2"-4")</td> <td>411.00</td> <td>-61-20 (5"-6")</td> <td>289.00</td> </tr> <tr> <td>-24 (5"-6")</td> <td>671.00</td> <td>-VP</td> <td>25.00</td> </tr> </table>	LIST PRICE			PIPE SIZE	24720	24720-45	2", 3", 4"	\$305.00	\$305.00	5", 6"	579.00	579.00	-45	\$0.00	-50	\$466.00	-20 (2"-4")	110.00	-51	347.00	-20 (5"-6")	220.00	-61 (2"-4")	155.00	-23 (2"-4")	197.00	-61 (5"-6")	260.00	-23 (5"-6")	321.00	-61-20 (2"-4")	222.00	-24 (2"-4")	411.00	-61-20 (5"-6")	289.00	-24 (5"-6")	671.00	-VP	25.00	<p align="center">OPTION DESCRIPTIONS</p> <ul style="list-style-type: none"> -BS Bird Screen -CR Clamping Drain Receiver -VP Vandal-Proof Dome -1 Deck Clamp Assembly -1C Drain Receiver Clips -2 Drain Receiver -3 Deck Clamp Assembly and Drain Receiver -3C Drain Receiver and Drain Receiver Clips -10 Fixed Extension Collar, Cast Iron -10-20 Fixed Extension Collar, Galvanized -12 Extended Flashing Collar, Cast Iron -12-20 Extended Flashing Collar, Galvanized -20 Galvanized Cast Iron Parts -22 Cast Iron Grate -23 Rough Bronze Grate -24 Rough Nikaloy Dome or Grate -27 High Dome -29 Sediment Bucket, Cast Iron -29-20 Sediment Bucket, Galvanized -31 Chain Anchored Grate -33 Stainless Mesh Screen-Covered Dome -35 Flat Grate -36 Ductile Iron Grate (Cast Iron Top Only) -38 Less Grate -50 C.I. Undergrate Laminated Top, Satin Finish Nikaloy -51 C.I. Undergrate Laminated Top, Satin Finish Bronze -60 Square Top, Cast Iron -60-50 Square Top, Satin Finish Nikaloy -60-51 Square Top, Satin Finish Bronze -61 Downspout Elbow, Cast Iron -61-20 Downspout Elbow, Galvanized -62 Ornamental Gargoyle, Cast Iron -62-20 Ornamental Gargoyle, Galvanized <p>Outlets</p> <ul style="list-style-type: none"> -45 Body with 45 Degree Threaded Outlet -66 No-Hub Side Outlet, 2" - 6" -90 Body with 90 Degree Threaded Outlet -T Threaded Outlet -TSO Threaded Side Outlet -X Inside Caulk Outlet -Y Hub Outlet with Gasket, 2" - 4" -Z No-Hub Spigot Outlet 																											
LIST PRICE																																																																					
PIPE SIZE	24720	24720-45																																																																			
2", 3", 4"	\$305.00	\$305.00																																																																			
5", 6"	579.00	579.00																																																																			
-45	\$0.00	-50	\$466.00																																																																		
-20 (2"-4")	110.00	-51	347.00																																																																		
-20 (5"-6")	220.00	-61 (2"-4")	155.00																																																																		
-23 (2"-4")	197.00	-61 (5"-6")	260.00																																																																		
-23 (5"-6")	321.00	-61-20 (2"-4")	222.00																																																																		
-24 (2"-4")	411.00	-61-20 (5"-6")	289.00																																																																		
-24 (5"-6")	671.00	-VP	25.00																																																																		
 <p>24900</p>	<p align="center">PARAPET TYPE, ANGLE DOME GRATE</p> <table border="1"> <thead> <tr> <th colspan="3">LIST PRICE</th> </tr> <tr> <th>PIPE SIZE</th> <th>2"-6"</th> <th>\$1,728.00</th> </tr> </thead> <tbody> <tr> <td></td> <td></td> <td></td> </tr> </tbody> </table> <p>ADD FOR OPTIONS:</p> <table> <tr> <td>-20</td> <td>\$245.00</td> <td>-61 (5"-6")</td> <td>\$260.00</td> </tr> <tr> <td>-24</td> <td>269.00</td> <td>-61-20 (2"-4")</td> <td>222.00</td> </tr> <tr> <td>-50</td> <td>351.00</td> <td>-61-20 (5"-6")</td> <td>289.00</td> </tr> <tr> <td>-51</td> <td>248.00</td> <td>-VP</td> <td>28.00</td> </tr> <tr> <td>-61 (2"-4")</td> <td>155.00</td> <td></td> <td></td> </tr> </table>	LIST PRICE			PIPE SIZE	2"-6"	\$1,728.00				-20	\$245.00	-61 (5"-6")	\$260.00	-24	269.00	-61-20 (2"-4")	222.00	-50	351.00	-61-20 (5"-6")	289.00	-51	248.00	-VP	28.00	-61 (2"-4")	155.00																																									
LIST PRICE																																																																					
PIPE SIZE	2"-6"	\$1,728.00																																																																			
-20	\$245.00	-61 (5"-6")	\$260.00																																																																		
-24	269.00	-61-20 (2"-4")	222.00																																																																		
-50	351.00	-61-20 (5"-6")	289.00																																																																		
-51	248.00	-VP	28.00																																																																		
-61 (2"-4")	155.00																																																																				
 <p>25000</p>	<p align="center">PARAPET SCUPPER SLEEVE</p> <table border="1"> <thead> <tr> <th colspan="5">LIST PRICE</th> </tr> <tr> <th>Wall Thickness</th> <th>9"</th> <th>13"</th> <th>17"</th> <th>21"</th> </tr> </thead> <tbody> <tr> <td></td> <td>\$431.00</td> <td>\$489.00</td> <td>\$605.00</td> <td>\$645.00</td> </tr> </tbody> </table> <p>ADD FOR OPTIONS:</p> <table> <tr> <td>-20</td> <td>\$109.00</td> <td>-62</td> <td>\$1,055.00</td> <td>-62-20</td> <td></td> </tr> </table>	LIST PRICE					Wall Thickness	9"	13"	17"	21"		\$431.00	\$489.00	\$605.00	\$645.00	-20	\$109.00	-62	\$1,055.00	-62-20																																																
LIST PRICE																																																																					
Wall Thickness	9"	13"	17"	21"																																																																	
	\$431.00	\$489.00	\$605.00	\$645.00																																																																	
-20	\$109.00	-62	\$1,055.00	-62-20																																																																	
 <p>25010</p>	<p align="center">DOWNSPOUT NOZZLE</p> <table border="1"> <thead> <tr> <th colspan="6">LIST PRICE</th> </tr> <tr> <th>PIPE SIZE</th> <th>2", 3", 4"</th> <th>5", 6"</th> <th>8"</th> <th>10"</th> <th>*12"</th> </tr> </thead> <tbody> <tr> <td></td> <td>\$288.00</td> <td>\$685.00</td> <td>\$1,042.00</td> <td>\$1,352.00</td> <td>\$2,008.00</td> </tr> </tbody> </table> <p>ADD FOR OPTIONS:</p> <table> <tr> <td>-24 (2"-6")</td> <td>\$209.00</td> <td>-51 (10")</td> <td>\$179.00</td> </tr> <tr> <td>-24 (8")</td> <td>184.00</td> <td>-BS</td> <td>253.00</td> </tr> <tr> <td>-24 (10")</td> <td>246.00</td> <td>-T</td> <td>0.00</td> </tr> <tr> <td>-51 (2"-6")</td> <td>131.00</td> <td>-Z (Bronze Only)</td> <td>0.00</td> </tr> <tr> <td>-51 (8")</td> <td>138.00</td> <td></td> <td></td> </tr> </table> <p>*12" Size No-Hub Only</p>	LIST PRICE						PIPE SIZE	2", 3", 4"	5", 6"	8"	10"	*12"		\$288.00	\$685.00	\$1,042.00	\$1,352.00	\$2,008.00	-24 (2"-6")	\$209.00	-51 (10")	\$179.00	-24 (8")	184.00	-BS	253.00	-24 (10")	246.00	-T	0.00	-51 (2"-6")	131.00	-Z (Bronze Only)	0.00	-51 (8")	138.00																																
LIST PRICE																																																																					
PIPE SIZE	2", 3", 4"	5", 6"	8"	10"	*12"																																																																
	\$288.00	\$685.00	\$1,042.00	\$1,352.00	\$2,008.00																																																																
-24 (2"-6")	\$209.00	-51 (10")	\$179.00																																																																		
-24 (8")	184.00	-BS	253.00																																																																		
-24 (10")	246.00	-T	0.00																																																																		
-51 (2"-6")	131.00	-Z (Bronze Only)	0.00																																																																		
-51 (8")	138.00																																																																				

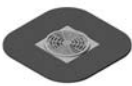
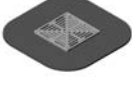
	<p>FLO-SEPTOR®, MEDIUM SUMP</p> <table border="1"> <thead> <tr> <th colspan="3">LIST PRICE</th> </tr> <tr> <th>PIPE SIZE</th> <th>2" - 6"</th> <th>\$332.00</th> </tr> </thead> <tbody> <tr> <td colspan="3">ADD FOR OPTIONS:</td> </tr> <tr> <td>-1</td> <td>\$69.00</td> <td>-20</td> <td>\$90.00</td> <td>-X</td> <td>\$0.00</td> </tr> <tr> <td>-2</td> <td>118.00</td> <td>-66</td> <td>71.00</td> <td>-Z</td> <td>0.00</td> </tr> <tr> <td>-3</td> <td>187.00</td> <td>-T</td> <td>36.00</td> <td></td> <td></td> </tr> </tbody> </table>	LIST PRICE			PIPE SIZE	2" - 6"	\$332.00	ADD FOR OPTIONS:			-1	\$69.00	-20	\$90.00	-X	\$0.00	-2	118.00	-66	71.00	-Z	0.00	-3	187.00	-T	36.00				<p>FLO-SET®, 15" DOME, LARGE SUMP</p> <table border="1"> <thead> <tr> <th colspan="3">LIST PRICE</th> </tr> <tr> <th>PIPE SIZE</th> <th>28600</th> <th>28600-AE</th> </tr> </thead> <tbody> <tr> <td>2", 3", 4" 5", 6"</td> <td>\$865.00 1,004.00</td> <td>\$1,191.00 1,330.00</td> </tr> <tr> <td colspan="3">ADD FOR OPTIONS:</td> </tr> <tr> <td>-AE</td> <td>\$326.00</td> <td>-3C</td> <td>\$170.00</td> <td>-VP</td> <td>\$57.00</td> </tr> <tr> <td>-CR</td> <td>192.00</td> <td>-4</td> <td>86.00</td> <td>-66</td> <td>170.00</td> </tr> <tr> <td>-1</td> <td>112.00</td> <td>-10**</td> <td>305.00</td> <td>-T</td> <td>36.00</td> </tr> <tr> <td>-1C*</td> <td>45.00</td> <td>-10-20**</td> <td>482.00</td> <td>-X</td> <td>0.00</td> </tr> <tr> <td>-2</td> <td>125.00</td> <td>-20</td> <td>409.00</td> <td>-Y</td> <td>0.00</td> </tr> <tr> <td>-3</td> <td>237.00</td> <td>-23</td> <td>382.00</td> <td>-Z</td> <td>0.00</td> </tr> </tbody> </table> <p>* Minimum Deck Opening 16.5" Dia. ** Specify Height, Price Each 4" or Fraction</p>	LIST PRICE			PIPE SIZE	28600	28600-AE	2", 3", 4" 5", 6"	\$865.00 1,004.00	\$1,191.00 1,330.00	ADD FOR OPTIONS:			-AE	\$326.00	-3C	\$170.00	-VP	\$57.00	-CR	192.00	-4	86.00	-66	170.00	-1	112.00	-10**	305.00	-T	36.00	-1C*	45.00	-10-20**	482.00	-X	0.00	-2	125.00	-20	409.00	-Y	0.00	-3	237.00	-23	382.00	-Z	0.00
LIST PRICE																																																																														
PIPE SIZE	2" - 6"	\$332.00																																																																												
ADD FOR OPTIONS:																																																																														
-1	\$69.00	-20	\$90.00	-X	\$0.00																																																																									
-2	118.00	-66	71.00	-Z	0.00																																																																									
-3	187.00	-T	36.00																																																																											
LIST PRICE																																																																														
PIPE SIZE	28600	28600-AE																																																																												
2", 3", 4" 5", 6"	\$865.00 1,004.00	\$1,191.00 1,330.00																																																																												
ADD FOR OPTIONS:																																																																														
-AE	\$326.00	-3C	\$170.00	-VP	\$57.00																																																																									
-CR	192.00	-4	86.00	-66	170.00																																																																									
-1	112.00	-10**	305.00	-T	36.00																																																																									
-1C*	45.00	-10-20**	482.00	-X	0.00																																																																									
-2	125.00	-20	409.00	-Y	0.00																																																																									
-3	237.00	-23	382.00	-Z	0.00																																																																									
	<p>FLO-SEPTOR®, SMALL SUMP</p> <table border="1"> <thead> <tr> <th colspan="3">LIST PRICE</th> </tr> <tr> <th>PIPE SIZE</th> <th>2", 3", 4"</th> <th>\$271.00</th> </tr> </thead> <tbody> <tr> <td colspan="3">ADD FOR OPTIONS:</td> </tr> <tr> <td>TSO*</td> <td>\$100.00</td> <td>-3</td> <td>\$187.00</td> <td>-X</td> <td>\$0.00</td> </tr> <tr> <td>-1</td> <td>69.00</td> <td>-20</td> <td>90.00</td> <td>-Y</td> <td>0.00</td> </tr> <tr> <td>-2</td> <td>118.00</td> <td>-T</td> <td>36.00</td> <td>-Z</td> <td>0.00</td> </tr> </tbody> </table> <p>* Cannot be used with Drain Receiver</p>	LIST PRICE			PIPE SIZE	2", 3", 4"	\$271.00	ADD FOR OPTIONS:			TSO*	\$100.00	-3	\$187.00	-X	\$0.00	-1	69.00	-20	90.00	-Y	0.00	-2	118.00	-T	36.00	-Z	0.00		<p>ISOLATION DECK DRAIN</p> <table border="1"> <thead> <tr> <th colspan="4">LIST PRICE</th> </tr> <tr> <th>PIPE SIZE</th> <th>2", 3", 4"</th> <th>5", 6"</th> <th>8"</th> </tr> </thead> <tbody> <tr> <td></td> <td>\$326.00</td> <td>\$463.00</td> <td>\$605.00</td> </tr> <tr> <td colspan="4">ADD FOR OPTIONS:</td> </tr> <tr> <td>-CR</td> <td>\$192.00</td> <td>-3C</td> <td>\$170.00</td> <td>-X</td> <td>\$0.00</td> </tr> <tr> <td>-1</td> <td>112.00</td> <td>-17</td> <td>105.00</td> <td>-Y</td> <td>0.00</td> </tr> <tr> <td>-1C*</td> <td>45.00</td> <td>-20</td> <td>377.00</td> <td>-Z</td> <td>0.00</td> </tr> <tr> <td>-2</td> <td>125.00</td> <td>-66</td> <td>170.00</td> <td></td> <td></td> </tr> <tr> <td>-3</td> <td>237.00</td> <td>-T</td> <td>36.00</td> <td></td> <td></td> </tr> </tbody> </table> <p>* Minimum Deck Opening 16.5" Dia.</p>	LIST PRICE				PIPE SIZE	2", 3", 4"	5", 6"	8"		\$326.00	\$463.00	\$605.00	ADD FOR OPTIONS:				-CR	\$192.00	-3C	\$170.00	-X	\$0.00	-1	112.00	-17	105.00	-Y	0.00	-1C*	45.00	-20	377.00	-Z	0.00	-2	125.00	-66	170.00			-3	237.00	-T	36.00				
LIST PRICE																																																																														
PIPE SIZE	2", 3", 4"	\$271.00																																																																												
ADD FOR OPTIONS:																																																																														
TSO*	\$100.00	-3	\$187.00	-X	\$0.00																																																																									
-1	69.00	-20	90.00	-Y	0.00																																																																									
-2	118.00	-T	36.00	-Z	0.00																																																																									
LIST PRICE																																																																														
PIPE SIZE	2", 3", 4"	5", 6"	8"																																																																											
	\$326.00	\$463.00	\$605.00																																																																											
ADD FOR OPTIONS:																																																																														
-CR	\$192.00	-3C	\$170.00	-X	\$0.00																																																																									
-1	112.00	-17	105.00	-Y	0.00																																																																									
-1C*	45.00	-20	377.00	-Z	0.00																																																																									
-2	125.00	-66	170.00																																																																											
-3	237.00	-T	36.00																																																																											
	<p>EXPANSION JOINT</p> <table border="1"> <thead> <tr> <th colspan="5">LIST PRICE</th> </tr> <tr> <th>PIPE SIZE</th> <th>2"</th> <th>3"</th> <th>4"</th> <th>5"</th> </tr> </thead> <tbody> <tr> <td></td> <td>\$305.00</td> <td>\$326.00</td> <td>\$367.00</td> <td>\$534.00</td> </tr> <tr> <th>PIPE SIZE</th> <th>6"</th> <th>8"</th> <th>10"</th> <td></td> </tr> <tr> <td></td> <td>\$612.00</td> <td>\$1,081.00</td> <td>\$2,250.00</td> <td></td> </tr> <tr> <td colspan="5">ADD FOR OPTIONS:</td> </tr> <tr> <td>-20</td> <td colspan="4">\$81.00</td> </tr> </tbody> </table>	LIST PRICE					PIPE SIZE	2"	3"	4"	5"		\$305.00	\$326.00	\$367.00	\$534.00	PIPE SIZE	6"	8"	10"			\$612.00	\$1,081.00	\$2,250.00		ADD FOR OPTIONS:					-20	\$81.00					<p>16" DOME, EXTRA LARGE SUMP</p> <table border="1"> <thead> <tr> <th colspan="3">LIST PRICE</th> </tr> <tr> <th>PIPE SIZE</th> <th>12"</th> <th>\$1,083.00</th> </tr> </thead> <tbody> <tr> <td colspan="3">ADD FOR OPTIONS:</td> </tr> <tr> <td>-1</td> <td>\$221.00</td> <td>-10*</td> <td>\$455.00</td> <td>-20</td> <td>\$656.00</td> </tr> <tr> <td>-2</td> <td>248.00</td> <td>-10-20*</td> <td>717.00</td> <td>-VP</td> <td>57.00</td> </tr> <tr> <td>-3</td> <td>469.00</td> <td>-17</td> <td>314.00</td> <td>-Z</td> <td>0.00</td> </tr> </tbody> </table> <p>* Specify Height, Price Each 4" or Fraction</p>	LIST PRICE			PIPE SIZE	12"	\$1,083.00	ADD FOR OPTIONS:			-1	\$221.00	-10*	\$455.00	-20	\$656.00	-2	248.00	-10-20*	717.00	-VP	57.00	-3	469.00	-17	314.00	-Z	0.00													
LIST PRICE																																																																														
PIPE SIZE	2"	3"	4"	5"																																																																										
	\$305.00	\$326.00	\$367.00	\$534.00																																																																										
PIPE SIZE	6"	8"	10"																																																																											
	\$612.00	\$1,081.00	\$2,250.00																																																																											
ADD FOR OPTIONS:																																																																														
-20	\$81.00																																																																													
LIST PRICE																																																																														
PIPE SIZE	12"	\$1,083.00																																																																												
ADD FOR OPTIONS:																																																																														
-1	\$221.00	-10*	\$455.00	-20	\$656.00																																																																									
-2	248.00	-10-20*	717.00	-VP	57.00																																																																									
-3	469.00	-17	314.00	-Z	0.00																																																																									
	<p>STACK FLASHING FITTING</p> <table border="1"> <thead> <tr> <th colspan="4">LIST PRICE</th> </tr> <tr> <th>PIPE SIZE</th> <th>1 1/2"</th> <th>2"</th> <th>3"</th> </tr> </thead> <tbody> <tr> <td></td> <td>\$87.00</td> <td>\$87.00</td> <td>\$100.00</td> </tr> <tr> <th>PIPE SIZE</th> <th>4"</th> <th>5"</th> <th>6"</th> </tr> <tr> <td></td> <td>\$129.00</td> <td>\$187.00</td> <td>\$187.00</td> </tr> <tr> <td colspan="4">ADD FOR OPTIONS:</td> </tr> <tr> <td>-20</td> <td colspan="3">\$85.00</td> </tr> </tbody> </table>	LIST PRICE				PIPE SIZE	1 1/2"	2"	3"		\$87.00	\$87.00	\$100.00	PIPE SIZE	4"	5"	6"		\$129.00	\$187.00	\$187.00	ADD FOR OPTIONS:				-20	\$85.00				<p>Roof Drain OPTION DESCRIPTIONS</p> <ul style="list-style-type: none"> -AE LEVELEZE® Adjustable Extension -CR Clamping Drain Receiver -VP Vandal-Proof Dome -1 Deck Clamp Assembly -1C Drain Receiver Clips -2 Drain Receiver -3 Deck Clamp Assembly and Drain Receiver -3C Drain Receiver and Drain Receiver Clips -4 Secondary Flashing Clamp (use with -AE Only) -10 Fixed Extension Collar, Cast Iron -10-20 Fixed Extension Collar, Galvanized -17 2" High Solid Clamping Collar -20 Galvanized Cast Iron Parts -23 Rough Bronze Dome -63 All Rough Bronze -65 All Rough Nikaloy <p>Outlets</p> <ul style="list-style-type: none"> -66 No-Hub Side Outlet, 2" - 6" -T Threaded Outlet -TSO Threaded Side Outlet -X Inside Caulk Outlet -Y Hub Outlet with Gasket, 2" - 4" -Z No-Hub Spigot Outlet 																																															
LIST PRICE																																																																														
PIPE SIZE	1 1/2"	2"	3"																																																																											
	\$87.00	\$87.00	\$100.00																																																																											
PIPE SIZE	4"	5"	6"																																																																											
	\$129.00	\$187.00	\$187.00																																																																											
ADD FOR OPTIONS:																																																																														
-20	\$85.00																																																																													
	<p>VENT STACK FLASHING SLEEVE</p> <table border="1"> <thead> <tr> <th colspan="4">LIST PRICE</th> </tr> <tr> <th>PIPE SIZE</th> <th>1 1/2"</th> <th>2"</th> <th>3"</th> </tr> </thead> <tbody> <tr> <td></td> <td>\$28.00</td> <td>\$28.00</td> <td>\$50.00</td> </tr> <tr> <th>PIPE SIZE</th> <th>4"</th> <th>5"</th> <th>6"</th> </tr> <tr> <td></td> <td>\$57.00</td> <td>\$74.00</td> <td>\$144.00</td> </tr> <tr> <td colspan="4">ADD FOR OPTIONS:</td> </tr> <tr> <td>-20</td> <td colspan="3">\$37.00</td> </tr> </tbody> </table>	LIST PRICE				PIPE SIZE	1 1/2"	2"	3"		\$28.00	\$28.00	\$50.00	PIPE SIZE	4"	5"	6"		\$57.00	\$74.00	\$144.00	ADD FOR OPTIONS:				-20	\$37.00																																																			
LIST PRICE																																																																														
PIPE SIZE	1 1/2"	2"	3"																																																																											
	\$28.00	\$28.00	\$50.00																																																																											
PIPE SIZE	4"	5"	6"																																																																											
	\$57.00	\$74.00	\$144.00																																																																											
ADD FOR OPTIONS:																																																																														
-20	\$37.00																																																																													
	<p>VANDAL-PROOF VENT CAP</p> <table border="1"> <thead> <tr> <th colspan="5">LIST PRICE</th> </tr> <tr> <th>PIPE SIZE</th> <th>1 1/2"</th> <th>2"</th> <th>2 1/2"</th> <th>3"</th> </tr> </thead> <tbody> <tr> <td></td> <td>\$192.00</td> <td>\$192.00</td> <td>\$216.00</td> <td>\$216.00</td> </tr> <tr> <th>PIPE SIZE</th> <th>4"</th> <th>5"</th> <th>6"</th> <td></td> </tr> <tr> <td></td> <td>\$242.00</td> <td>\$283.00</td> <td>\$309.00</td> <td></td> </tr> <tr> <td colspan="5">ADD FOR OPTIONS:</td> </tr> <tr> <td>-20</td> <td>\$80.00</td> <td>-63</td> <td>\$192.00</td> <td>-65</td> <td>\$209.00</td> </tr> </tbody> </table>	LIST PRICE					PIPE SIZE	1 1/2"	2"	2 1/2"	3"		\$192.00	\$192.00	\$216.00	\$216.00	PIPE SIZE	4"	5"	6"			\$242.00	\$283.00	\$309.00		ADD FOR OPTIONS:					-20	\$80.00	-63	\$192.00	-65	\$209.00																																									
LIST PRICE																																																																														
PIPE SIZE	1 1/2"	2"	2 1/2"	3"																																																																										
	\$192.00	\$192.00	\$216.00	\$216.00																																																																										
PIPE SIZE	4"	5"	6"																																																																											
	\$242.00	\$283.00	\$309.00																																																																											
ADD FOR OPTIONS:																																																																														
-20	\$80.00	-63	\$192.00	-65	\$209.00																																																																									

<p>A</p> 	<p>ROUND NIKALOY SUPER-FLO® STRAINER</p> <p>LIST PRICE</p> <table border="1"> <thead> <tr> <th>Strainer</th> <th>Strainer Only</th> <th>With 30000</th> <th>With 30304</th> <th>With 30000-ST</th> </tr> </thead> <tbody> <tr><td>5A</td><td>\$133.00</td><td>\$220.00</td><td>\$173.00</td><td>\$427.00</td></tr> <tr><td>6A</td><td>183.00</td><td>270.00</td><td>223.00</td><td>477.00</td></tr> <tr><td>7A</td><td>225.00</td><td>312.00</td><td>265.00</td><td>519.00</td></tr> <tr><td>8A</td><td>305.00</td><td>392.00</td><td>345.00</td><td>599.00</td></tr> <tr><td>9A*</td><td>448.00</td><td>535.00</td><td>488.00</td><td>742.00</td></tr> <tr><td>10A*</td><td>448.00</td><td>535.00</td><td>488.00</td><td>742.00</td></tr> </tbody> </table> <p>ADD FOR OPTIONS:</p> <table border="0"> <tr><td>-SS (5A - 8A)</td><td>\$0.00</td><td>-80.....</td><td>\$50.00</td></tr> <tr><td>-2 (5A).....</td><td>Deduct 11.00</td><td>-5A-CP.....</td><td>20.00</td></tr> <tr><td>-2 (6A).....</td><td>Deduct 27.00</td><td>-6A-CP.....</td><td>22.00</td></tr> <tr><td>-2 (7A).....</td><td>Deduct 16.00</td><td>-J</td><td>174.00</td></tr> <tr><td>-2 (8A).....</td><td>Deduct 21.00</td><td>-VP</td><td>25.00</td></tr> <tr><td>-2 (9A, 10A)* ..</td><td>Deduct 28.00</td><td></td><td></td></tr> </table> <p><small>* Not SUPER-FLO® Design</small></p>	Strainer	Strainer Only	With 30000	With 30304	With 30000-ST	5A	\$133.00	\$220.00	\$173.00	\$427.00	6A	183.00	270.00	223.00	477.00	7A	225.00	312.00	265.00	519.00	8A	305.00	392.00	345.00	599.00	9A*	448.00	535.00	488.00	742.00	10A*	448.00	535.00	488.00	742.00	-SS (5A - 8A)	\$0.00	-80.....	\$50.00	-2 (5A).....	Deduct 11.00	-5A-CP.....	20.00	-2 (6A).....	Deduct 27.00	-6A-CP.....	22.00	-2 (7A).....	Deduct 16.00	-J	174.00	-2 (8A).....	Deduct 21.00	-VP	25.00	-2 (9A, 10A)* ..	Deduct 28.00			<p>E</p> 	<p>ROUND NIKALOY TRACTOR STRAINER</p> <p>LIST PRICE</p> <table border="1"> <thead> <tr> <th>Strainer</th> <th>Strainer Only</th> <th>With 30000</th> <th>With 30304</th> <th>With 30000-ST</th> </tr> </thead> <tbody> <tr><td>6E</td><td>\$338.00</td><td>\$425.00</td><td>\$378.00</td><td>\$632.00</td></tr> <tr><td>7E</td><td>426.00</td><td>513.00</td><td>466.00</td><td>720.00</td></tr> <tr><td>9E</td><td>624.00</td><td>711.00</td><td>664.00</td><td>918.00</td></tr> </tbody> </table> <p>ADD FOR OPTIONS:</p> <table border="0"> <tr><td>-2 (6E)</td><td>Deduct \$27.00</td><td>-93.....</td><td>Deduct \$263.00</td></tr> <tr><td>-2 (7E)</td><td>Deduct 43.00</td><td>-J</td><td>174.00</td></tr> <tr><td>-2 (9E)</td><td>Deduct 50.00</td><td>-VP</td><td>25.00</td></tr> <tr><td>-80.....</td><td>50.00</td><td></td><td></td></tr> </table>	Strainer	Strainer Only	With 30000	With 30304	With 30000-ST	6E	\$338.00	\$425.00	\$378.00	\$632.00	7E	426.00	513.00	466.00	720.00	9E	624.00	711.00	664.00	918.00	-2 (6E)	Deduct \$27.00	-93.....	Deduct \$263.00	-2 (7E)	Deduct 43.00	-J	174.00	-2 (9E)	Deduct 50.00	-VP	25.00	-80.....	50.00		
Strainer	Strainer Only	With 30000	With 30304	With 30000-ST																																																																																														
5A	\$133.00	\$220.00	\$173.00	\$427.00																																																																																														
6A	183.00	270.00	223.00	477.00																																																																																														
7A	225.00	312.00	265.00	519.00																																																																																														
8A	305.00	392.00	345.00	599.00																																																																																														
9A*	448.00	535.00	488.00	742.00																																																																																														
10A*	448.00	535.00	488.00	742.00																																																																																														
-SS (5A - 8A)	\$0.00	-80.....	\$50.00																																																																																															
-2 (5A).....	Deduct 11.00	-5A-CP.....	20.00																																																																																															
-2 (6A).....	Deduct 27.00	-6A-CP.....	22.00																																																																																															
-2 (7A).....	Deduct 16.00	-J	174.00																																																																																															
-2 (8A).....	Deduct 21.00	-VP	25.00																																																																																															
-2 (9A, 10A)* ..	Deduct 28.00																																																																																																	
Strainer	Strainer Only	With 30000	With 30304	With 30000-ST																																																																																														
6E	\$338.00	\$425.00	\$378.00	\$632.00																																																																																														
7E	426.00	513.00	466.00	720.00																																																																																														
9E	624.00	711.00	664.00	918.00																																																																																														
-2 (6E)	Deduct \$27.00	-93.....	Deduct \$263.00																																																																																															
-2 (7E)	Deduct 43.00	-J	174.00																																																																																															
-2 (9E)	Deduct 50.00	-VP	25.00																																																																																															
-80.....	50.00																																																																																																	
<p>6AD</p> 	<p>ROUND NIKALOY STRAINER w/CLAMP DEVICE</p> <p>LIST PRICE</p> <table border="1"> <thead> <tr> <th>Strainer</th> <th>Strainer Only</th> <th>With 30000</th> <th>With 30304</th> <th>With 30000-ST</th> </tr> </thead> <tbody> <tr><td>6AD</td><td>\$641.00</td><td>\$728.00</td><td>\$681.00</td><td>\$935.00</td></tr> </tbody> </table> <p>ADD FOR OPTIONS:</p> <table border="0"> <tr><td>-2.....</td><td>Deduct \$73.00</td><td>-J</td><td>\$174.00</td></tr> <tr><td>-80.....</td><td>50.00</td><td>-VP</td><td>25.00</td></tr> </table>	Strainer	Strainer Only	With 30000	With 30304	With 30000-ST	6AD	\$641.00	\$728.00	\$681.00	\$935.00	-2.....	Deduct \$73.00	-J	\$174.00	-80.....	50.00	-VP	25.00	<p>E1</p> 	<p>ROUND NIKALOY STRAINER w/EXTENDED RIM</p> <p>LIST PRICE</p> <table border="1"> <thead> <tr> <th>Strainer</th> <th>Strainer Only</th> <th>With 30000</th> <th>With 30304</th> <th>With 30000-ST</th> </tr> </thead> <tbody> <tr><td>6E1</td><td>\$360.00</td><td>\$447.00</td><td>\$400.00</td><td>\$654.00</td></tr> <tr><td>7E1</td><td>426.00</td><td>513.00</td><td>466.00</td><td>720.00</td></tr> <tr><td>9E1</td><td>631.00</td><td>718.00</td><td>671.00</td><td>925.00</td></tr> </tbody> </table> <p>ADD FOR OPTIONS:</p> <table border="0"> <tr><td>-2 (6E1)</td><td>Deduct \$49.00</td><td>-80.....</td><td>\$50.00</td></tr> <tr><td>-2 (7E1)</td><td>Deduct 44.00</td><td>-J</td><td>174.00</td></tr> <tr><td>-2 (9E1)</td><td>Deduct 59.00</td><td>-VP</td><td>25.00</td></tr> </table>	Strainer	Strainer Only	With 30000	With 30304	With 30000-ST	6E1	\$360.00	\$447.00	\$400.00	\$654.00	7E1	426.00	513.00	466.00	720.00	9E1	631.00	718.00	671.00	925.00	-2 (6E1)	Deduct \$49.00	-80.....	\$50.00	-2 (7E1)	Deduct 44.00	-J	174.00	-2 (9E1)	Deduct 59.00	-VP	25.00																																													
Strainer	Strainer Only	With 30000	With 30304	With 30000-ST																																																																																														
6AD	\$641.00	\$728.00	\$681.00	\$935.00																																																																																														
-2.....	Deduct \$73.00	-J	\$174.00																																																																																															
-80.....	50.00	-VP	25.00																																																																																															
Strainer	Strainer Only	With 30000	With 30304	With 30000-ST																																																																																														
6E1	\$360.00	\$447.00	\$400.00	\$654.00																																																																																														
7E1	426.00	513.00	466.00	720.00																																																																																														
9E1	631.00	718.00	671.00	925.00																																																																																														
-2 (6E1)	Deduct \$49.00	-80.....	\$50.00																																																																																															
-2 (7E1)	Deduct 44.00	-J	174.00																																																																																															
-2 (9E1)	Deduct 59.00	-VP	25.00																																																																																															
<p>AF</p> 	<p>ROUND NIKALOY STRAINER WITH TILE FLANGE</p> <p>LIST PRICE</p> <table border="1"> <thead> <tr> <th>Strainer</th> <th>Strainer Only</th> <th>With 30000</th> <th>With 30304</th> <th>With 30000-ST</th> </tr> </thead> <tbody> <tr><td>6AF</td><td>\$426.00</td><td>\$513.00</td><td>\$466.00</td><td>\$720.00</td></tr> </tbody> </table> <p>ADD FOR OPTIONS:</p> <table border="0"> <tr><td>-2.....</td><td>Deduct \$43.00</td><td>-J</td><td>\$174.00</td></tr> <tr><td>-80.....</td><td>50.00</td><td>-VP</td><td>25.00</td></tr> </table>	Strainer	Strainer Only	With 30000	With 30304	With 30000-ST	6AF	\$426.00	\$513.00	\$466.00	\$720.00	-2.....	Deduct \$43.00	-J	\$174.00	-80.....	50.00	-VP	25.00	<p>E2</p> 	<p>ROUND NIKALOY STRAINER w/ROUND FUNNEL</p> <p>LIST PRICE</p> <table border="1"> <thead> <tr> <th>Strainer</th> <th>Strainer Only</th> <th>With 30000</th> <th>With 30304</th> <th>With 30000-ST</th> </tr> </thead> <tbody> <tr><td>7E2</td><td>\$421.00</td><td>\$508.00</td><td>\$461.00</td><td>\$715.00</td></tr> </tbody> </table> <p>ADD FOR OPTIONS:</p> <table border="0"> <tr><td>-2.....</td><td>Deduct \$44.00</td><td>-J</td><td>\$174.00</td></tr> <tr><td>-80.....</td><td>50.00</td><td>-VP</td><td>25.00</td></tr> </table>	Strainer	Strainer Only	With 30000	With 30304	With 30000-ST	7E2	\$421.00	\$508.00	\$461.00	\$715.00	-2.....	Deduct \$44.00	-J	\$174.00	-80.....	50.00	-VP	25.00																																																											
Strainer	Strainer Only	With 30000	With 30304	With 30000-ST																																																																																														
6AF	\$426.00	\$513.00	\$466.00	\$720.00																																																																																														
-2.....	Deduct \$43.00	-J	\$174.00																																																																																															
-80.....	50.00	-VP	25.00																																																																																															
Strainer	Strainer Only	With 30000	With 30304	With 30000-ST																																																																																														
7E2	\$421.00	\$508.00	\$461.00	\$715.00																																																																																														
-2.....	Deduct \$44.00	-J	\$174.00																																																																																															
-80.....	50.00	-VP	25.00																																																																																															
<p>5C</p> 	<p>ROUND NIKALOY NON-CLOG STRAINER WITH INTEGRAL BUCKET</p> <p>LIST PRICE</p> <table border="1"> <thead> <tr> <th>Strainer</th> <th>Strainer Only</th> <th>With 30000</th> <th>With 30304</th> <th>With 30000-ST</th> </tr> </thead> <tbody> <tr><td>5C</td><td>\$353.00</td><td>\$440.00</td><td>\$393.00</td><td>\$647.00</td></tr> </tbody> </table> <p>ADD FOR OPTIONS:</p> <table border="0"> <tr><td>-2.....</td><td>Deduct \$20.00</td><td>-VP</td><td>\$25.00</td></tr> </table>	Strainer	Strainer Only	With 30000	With 30304	With 30000-ST	5C	\$353.00	\$440.00	\$393.00	\$647.00	-2.....	Deduct \$20.00	-VP	\$25.00	<p>E3</p> 	<p>ROUND NIKALOY STRAINER w/OVAL FUNNEL</p> <p>LIST PRICE</p> <table border="1"> <thead> <tr> <th>Strainer</th> <th>Strainer Only</th> <th>With 30000</th> <th>With 30304</th> <th>With 30000-ST</th> </tr> </thead> <tbody> <tr><td>7E3</td><td>\$629.00</td><td>\$716.00</td><td>\$669.00</td><td>\$923.00</td></tr> </tbody> </table> <p>ADD FOR OPTIONS:</p> <table border="0"> <tr><td>-2.....</td><td>Deduct \$44.00</td><td>-J</td><td>\$174.00</td></tr> <tr><td>-80.....</td><td>50.00</td><td>-VP</td><td>25.00</td></tr> </table>	Strainer	Strainer Only	With 30000	With 30304	With 30000-ST	7E3	\$629.00	\$716.00	\$669.00	\$923.00	-2.....	Deduct \$44.00	-J	\$174.00	-80.....	50.00	-VP	25.00																																																															
Strainer	Strainer Only	With 30000	With 30304	With 30000-ST																																																																																														
5C	\$353.00	\$440.00	\$393.00	\$647.00																																																																																														
-2.....	Deduct \$20.00	-VP	\$25.00																																																																																															
Strainer	Strainer Only	With 30000	With 30304	With 30000-ST																																																																																														
7E3	\$629.00	\$716.00	\$669.00	\$923.00																																																																																														
-2.....	Deduct \$44.00	-J	\$174.00																																																																																															
-80.....	50.00	-VP	25.00																																																																																															
<p>D</p> 	<p>ROUND NIKALOY DOME STRAINER</p> <p>LIST PRICE</p> <table border="1"> <thead> <tr> <th>Strainer</th> <th>Strainer Only</th> <th>With 30000</th> <th>With 30304</th> <th>With 30000-ST</th> </tr> </thead> <tbody> <tr><td>5D</td><td>\$225.00</td><td>\$312.00</td><td>\$265.00</td><td>\$519.00</td></tr> <tr><td>6D</td><td>287.00</td><td>374.00</td><td>327.00</td><td>581.00</td></tr> </tbody> </table> <p>ADD FOR OPTIONS:</p> <table border="0"> <tr><td>-2 (5D).....</td><td>Deduct \$17.00</td><td>-J</td><td>\$174.00</td></tr> <tr><td>-2 (6D).....</td><td>Deduct 36.00</td><td>-VP</td><td>25.00</td></tr> <tr><td>-80.....</td><td>50.00</td><td></td><td></td></tr> </table>	Strainer	Strainer Only	With 30000	With 30304	With 30000-ST	5D	\$225.00	\$312.00	\$265.00	\$519.00	6D	287.00	374.00	327.00	581.00	-2 (5D).....	Deduct \$17.00	-J	\$174.00	-2 (6D).....	Deduct 36.00	-VP	25.00	-80.....	50.00			<p>Strainer OPTION DESCRIPTIONS</p> <ul style="list-style-type: none"> -CP Chrome Plated -J Backwater Valve -SS Stainless Steel -VP Secured Grate, Vandal-Proof Screws -2 Satin Finish Bronze -80 Perforated Stainless Steel Basket -93 Cast Iron Strainer 																																																																					
Strainer	Strainer Only	With 30000	With 30304	With 30000-ST																																																																																														
5D	\$225.00	\$312.00	\$265.00	\$519.00																																																																																														
6D	287.00	374.00	327.00	581.00																																																																																														
-2 (5D).....	Deduct \$17.00	-J	\$174.00																																																																																															
-2 (6D).....	Deduct 36.00	-VP	25.00																																																																																															
-80.....	50.00																																																																																																	

 <p>F</p>	<p>ROUND NIKALOY STRAINER WITH SOLID THREADED COVER</p> <p>LIST PRICE</p> <table border="1"> <thead> <tr> <th>Strainer</th> <th>Strainer Only</th> <th>With 30000</th> <th>With 30304</th> <th>With 30000-ST</th> </tr> </thead> <tbody> <tr> <td>6F</td> <td>\$432.00</td> <td>\$519.00</td> <td>\$472.00</td> <td>\$726.00</td> </tr> </tbody> </table> <p>ADD FOR OPTIONS:</p> <p>-2..... Deduct \$34.00 -80..... Deduct \$50.00 -63..... Deduct 63.00 -J Deduct 174.00</p>	Strainer	Strainer Only	With 30000	With 30304	With 30000-ST	6F	\$432.00	\$519.00	\$472.00	\$726.00	 <p>M</p>	<p>ROUND CHROME PLATED OVERFLOW STANDPIPE WITH DOME</p> <p>LIST PRICE</p> <table border="1"> <thead> <tr> <th>Strainer</th> <th>Strainer Only</th> <th>With 30000</th> <th>With 30304</th> <th>With 30000-ST</th> </tr> </thead> <tbody> <tr> <td>2M</td> <td>\$812.00</td> <td>\$899.00</td> <td>\$852.00</td> <td>\$1,106.00</td> </tr> <tr> <td>3M</td> <td>1,037.00</td> <td>1,124.00</td> <td>1,077.00</td> <td>1,331.00</td> </tr> </tbody> </table> <p>ADD FOR OPTIONS:</p> <p>-2 (2M)..... Deduct \$138.00 -24 (3M)..... Deduct \$174.00 -2 (3M)..... Deduct 86.00 -PF..... Deduct 159.00 -24 (2M)..... Deduct 130.00</p> <p>For Each Inch Over 6" Standard CP -2</p> <p>Add for 2M \$62.00 \$45.00 Add for 3M 88.00 78.00</p>	Strainer	Strainer Only	With 30000	With 30304	With 30000-ST	2M	\$812.00	\$899.00	\$852.00	\$1,106.00	3M	1,037.00	1,124.00	1,077.00	1,331.00																									
Strainer	Strainer Only	With 30000	With 30304	With 30000-ST																																																	
6F	\$432.00	\$519.00	\$472.00	\$726.00																																																	
Strainer	Strainer Only	With 30000	With 30304	With 30000-ST																																																	
2M	\$812.00	\$899.00	\$852.00	\$1,106.00																																																	
3M	1,037.00	1,124.00	1,077.00	1,331.00																																																	
 <p>F4, F6</p>	<p>ROUND NIKALOY FUNNEL ASSEMBLIES</p> <p>LIST PRICE</p> <table border="1"> <thead> <tr> <th>Funnel</th> <th></th> </tr> </thead> <tbody> <tr> <td>F4</td> <td>\$195.00</td> </tr> <tr> <td>F6</td> <td>288.00</td> </tr> </tbody> </table> <p>ADD FOR OPTIONS:</p> <p>-2..... Deduct \$28.00 -93 (F4) Deduct \$114.00 -92 (F4) Deduct 88.00 -93 (F6) Deduct 157.00 -92 (F6) Deduct 132.00</p>	Funnel		F4	\$195.00	F6	288.00	 <p>P</p>	<p>ANGLE NIKALOY STRAINER</p> <p>LIST PRICE</p> <table border="1"> <thead> <tr> <th>Strainer</th> <th>Strainer Only</th> <th>With 30000</th> <th>With 30304</th> <th>With 30000-ST</th> </tr> </thead> <tbody> <tr> <td>4P</td> <td>\$812.00</td> <td>\$899.00</td> <td>\$852.00</td> <td>\$1,106.00</td> </tr> <tr> <td>6P</td> <td>1,037.00</td> <td>1,124.00</td> <td>1,077.00</td> <td>1,331.00</td> </tr> </tbody> </table> <p>ADD FOR OPTIONS:</p> <p>-2 (4P) Deduct \$69.00 -80..... Deduct \$54.00 -2 (6P) Deduct 86.00 -VP Deduct 25.00</p>	Strainer	Strainer Only	With 30000	With 30304	With 30000-ST	4P	\$812.00	\$899.00	\$852.00	\$1,106.00	6P	1,037.00	1,124.00	1,077.00	1,331.00																													
Funnel																																																					
F4	\$195.00																																																				
F6	288.00																																																				
Strainer	Strainer Only	With 30000	With 30304	With 30000-ST																																																	
4P	\$812.00	\$899.00	\$852.00	\$1,106.00																																																	
6P	1,037.00	1,124.00	1,077.00	1,331.00																																																	
 <p>F8, F9</p>	<p>OVAL NIKALOY FUNNEL ASSEMBLIES</p> <p>LIST PRICE</p> <table border="1"> <thead> <tr> <th>Funnel</th> <th></th> </tr> </thead> <tbody> <tr> <td>F8</td> <td>\$195.00</td> </tr> <tr> <td>F9</td> <td>404.00</td> </tr> </tbody> </table> <p>ADD FOR OPTIONS:</p> <p>-2..... Deduct \$28.00 -93 (F8) Deduct \$114.00 -92 (F8) Deduct 88.00 -93 (F9) Deduct 208.00 -92 (F9) Deduct 181.00</p>	Funnel		F8	\$195.00	F9	404.00	 <p>R</p>	<p>RECTANGULAR NIKALOY STRAINER</p> <p>LIST PRICE</p> <table border="1"> <thead> <tr> <th>Strainer</th> <th>Strainer Only</th> <th>With 30000</th> <th>With 30304</th> <th>With 30000-ST</th> </tr> </thead> <tbody> <tr> <td>5R</td> <td>\$399.00</td> <td>\$486.00</td> <td>\$439.00</td> <td>\$693.00</td> </tr> <tr> <td>6R</td> <td>572.00</td> <td>659.00</td> <td>612.00</td> <td>866.00</td> </tr> <tr> <td>7R</td> <td>613.00</td> <td>700.00</td> <td>653.00</td> <td>907.00</td> </tr> <tr> <td>8R</td> <td>925.00</td> <td>1,012.00</td> <td>965.00</td> <td>1,219.00</td> </tr> </tbody> </table> <p>ADD FOR OPTIONS:</p> <p>-2 (5R) Deduct \$36.00 -80 Deduct \$50.00 -2 (6R, 7R)..... Deduct 62.00 -J Deduct 174.00 -2 (8R)..... Deduct 120.00 -VP Deduct 25.00</p>	Strainer	Strainer Only	With 30000	With 30304	With 30000-ST	5R	\$399.00	\$486.00	\$439.00	\$693.00	6R	572.00	659.00	612.00	866.00	7R	613.00	700.00	653.00	907.00	8R	925.00	1,012.00	965.00	1,219.00																			
Funnel																																																					
F8	\$195.00																																																				
F9	404.00																																																				
Strainer	Strainer Only	With 30000	With 30304	With 30000-ST																																																	
5R	\$399.00	\$486.00	\$439.00	\$693.00																																																	
6R	572.00	659.00	612.00	866.00																																																	
7R	613.00	700.00	653.00	907.00																																																	
8R	925.00	1,012.00	965.00	1,219.00																																																	
 <p>G</p>	<p>ROUND NIKALOY STRAINER WITH SOLID HINGED COVER</p> <p>LIST PRICE</p> <table border="1"> <thead> <tr> <th>Strainer</th> <th>Strainer Only</th> <th>With 30000</th> <th>With 30304</th> <th>With 30000-ST</th> </tr> </thead> <tbody> <tr> <td>5G</td> <td>\$311.00</td> <td>\$398.00</td> <td>\$351.00</td> <td>\$605.00</td> </tr> <tr> <td>6G</td> <td>354.00</td> <td>441.00</td> <td>394.00</td> <td>648.00</td> </tr> <tr> <td>7G</td> <td>552.00</td> <td>639.00</td> <td>592.00</td> <td>846.00</td> </tr> <tr> <td>8G</td> <td>561.00</td> <td>648.00</td> <td>601.00</td> <td>855.00</td> </tr> </tbody> </table> <p>ADD FOR OPTIONS:</p> <p>-2 (5G) Deduct \$25.00 -2 (8G) Deduct \$50.00 -2 (6G) Deduct 49.00 -J Deduct 174.00 -2 (7G) Deduct 67.00 -VP Deduct 25.00</p>	Strainer	Strainer Only	With 30000	With 30304	With 30000-ST	5G	\$311.00	\$398.00	\$351.00	\$605.00	6G	354.00	441.00	394.00	648.00	7G	552.00	639.00	592.00	846.00	8G	561.00	648.00	601.00	855.00	 <p>S</p>	<p>SQUARE NIKALOY SUPER-FLO® STRAINER</p> <p>LIST PRICE</p> <table border="1"> <thead> <tr> <th>Strainer</th> <th>Strainer Only</th> <th>With 30000</th> <th>With 30304</th> <th>With 30000-ST</th> </tr> </thead> <tbody> <tr> <td>5S</td> <td>\$208.00</td> <td>\$295.00</td> <td>\$248.00</td> <td>\$502.00</td> </tr> <tr> <td>6S</td> <td>242.00</td> <td>329.00</td> <td>282.00</td> <td>536.00</td> </tr> <tr> <td>8S</td> <td>390.00</td> <td>477.00</td> <td>430.00</td> <td>684.00</td> </tr> <tr> <td>9S*</td> <td>519.00</td> <td>606.00</td> <td>559.00</td> <td>813.00</td> </tr> </tbody> </table> <p>ADD FOR OPTIONS:</p> <p>-SS (5S - 8S) \$0.00 -80..... Deduct \$50.00 -2 (5S) Deduct 25.00 -CP (5S) Deduct 25.00 -2 (6S) Deduct 16.00 -CP (6S) Deduct 30.00 -2 (8S) Deduct 44.00 -J Deduct 174.00 -2 (9S) * Deduct 50.00 -VP Deduct 25.00</p> <p>* Not SUPER-FLO® design</p>	Strainer	Strainer Only	With 30000	With 30304	With 30000-ST	5S	\$208.00	\$295.00	\$248.00	\$502.00	6S	242.00	329.00	282.00	536.00	8S	390.00	477.00	430.00	684.00	9S*	519.00	606.00	559.00	813.00
Strainer	Strainer Only	With 30000	With 30304	With 30000-ST																																																	
5G	\$311.00	\$398.00	\$351.00	\$605.00																																																	
6G	354.00	441.00	394.00	648.00																																																	
7G	552.00	639.00	592.00	846.00																																																	
8G	561.00	648.00	601.00	855.00																																																	
Strainer	Strainer Only	With 30000	With 30304	With 30000-ST																																																	
5S	\$208.00	\$295.00	\$248.00	\$502.00																																																	
6S	242.00	329.00	282.00	536.00																																																	
8S	390.00	477.00	430.00	684.00																																																	
9S*	519.00	606.00	559.00	813.00																																																	
 <p>H</p>	<p>ROUND NIKALOY STRAINER WITH HINGED GRATE</p> <p>LIST PRICE</p> <table border="1"> <thead> <tr> <th>Strainer</th> <th>Strainer Only</th> <th>With 30000</th> <th>With 30304</th> <th>With 30000-ST</th> </tr> </thead> <tbody> <tr> <td>5H</td> <td>\$260.00</td> <td>\$347.00</td> <td>\$300.00</td> <td>\$554.00</td> </tr> <tr> <td>6H</td> <td>287.00</td> <td>374.00</td> <td>327.00</td> <td>581.00</td> </tr> <tr> <td>7H</td> <td>354.00</td> <td>441.00</td> <td>394.00</td> <td>648.00</td> </tr> <tr> <td>8H</td> <td>399.00</td> <td>486.00</td> <td>439.00</td> <td>693.00</td> </tr> </tbody> </table> <p>ADD FOR OPTIONS:</p> <p>-2 (5H)..... Deduct \$18.00 -80 (6H - 8H)..... Deduct \$50.00 -2 (6H)..... Deduct 27.00 -J Deduct 174.00 -2 (7H)..... Deduct 16.00 -VP Deduct 25.00 -2 (8H)..... Deduct 36.00</p>	Strainer	Strainer Only	With 30000	With 30304	With 30000-ST	5H	\$260.00	\$347.00	\$300.00	\$554.00	6H	287.00	374.00	327.00	581.00	7H	354.00	441.00	394.00	648.00	8H	399.00	486.00	439.00	693.00	 <p>T</p>	<p>SQUARE NIKALOY STRAINER w/HINGED GRATE</p> <p>LIST PRICE</p> <table border="1"> <thead> <tr> <th>Strainer</th> <th>Strainer Only</th> <th>With 30000</th> <th>With 30304</th> <th>With 30000-ST</th> </tr> </thead> <tbody> <tr> <td>5T</td> <td>\$305.00</td> <td>\$392.00</td> <td>\$345.00</td> <td>\$599.00</td> </tr> <tr> <td>6T</td> <td>367.00</td> <td>454.00</td> <td>407.00</td> <td>661.00</td> </tr> <tr> <td>9T</td> <td>668.00</td> <td>755.00</td> <td>708.00</td> <td>962.00</td> </tr> </tbody> </table> <p>ADD FOR OPTIONS:</p> <p>-2 (5T) Deduct \$25.00 -J Deduct \$174.00 -2 (6T) Deduct 18.00 -SC (6T) Deduct 115.00 -2 (9T) Deduct 50.00 -VP Deduct 25.00 -80 (6T, 9T) 50.00</p>	Strainer	Strainer Only	With 30000	With 30304	With 30000-ST	5T	\$305.00	\$392.00	\$345.00	\$599.00	6T	367.00	454.00	407.00	661.00	9T	668.00	755.00	708.00	962.00					
Strainer	Strainer Only	With 30000	With 30304	With 30000-ST																																																	
5H	\$260.00	\$347.00	\$300.00	\$554.00																																																	
6H	287.00	374.00	327.00	581.00																																																	
7H	354.00	441.00	394.00	648.00																																																	
8H	399.00	486.00	439.00	693.00																																																	
Strainer	Strainer Only	With 30000	With 30304	With 30000-ST																																																	
5T	\$305.00	\$392.00	\$345.00	\$599.00																																																	
6T	367.00	454.00	407.00	661.00																																																	
9T	668.00	755.00	708.00	962.00																																																	

	CAST IRON STRAINER EXTENSION LIST PRICE					 NEW	BODY ASSEMBLY WITH SHALLOW TRAP LIST PRICE	
	Strainer	Strainer Only	With 30000	With 30304	With 30000-ST		PIPE SIZE	30000-ST
	2W	\$63.00	\$150.00	\$103.00	\$357.00	2", 3"	\$294.00	
Can be used with all Floor Drain Bodies on this Page.						ADD FOR OPTIONS: -ARE \$80.00 -92 \$90.00 -49 0.00 -Z 0.00 -50 STD		
WF6A WF6S  	NIKALOY STRAINERS FOR COMPOSITION DECKS LIST PRICE					 NEW	NO-HUB CAST IRON BODY LIST PRICE	
	Strainer	Strainer Only	With 30000	With 30304	With 30000-ST		PIPE SIZE	30304
	WF6A	\$494.00	\$581.00	\$534.00	\$788.00	4"	\$40.00	
	WF6S	552.00	639.00	592.00	846.00			
ADD FOR OPTIONS: -2 (6A) Deduct \$27.00 -J \$174.00 -2 (6S) Deduct 16.00 -VP 25.00 -80 50.00 Can be used with all Floor Drain Bodies on this Page.								
BODIES ONLY								
	30000 BODY ASSEMBLY LIST PRICE						BODY ASSEMBLY WITH TRAP & FLUSH WITH FLOOR CLEANOUT LIST PRICE	
	PIPE SIZE	30000	30000-TSO	30002-ST	30003-ST		30000-PD	PIPE SIZE
	2" - 4"	\$87.00	\$187.00	\$294.00	\$326.00	2" - 4"	\$519.00	
ADD FOR OPTIONS: -TSO \$100.00 -91 \$555.00 -ST 171.00 -92 90.00 -PD 239.00 -T 36.00 -MD 50.00 -X 0.00 -ARE 80.00 -Y 0.00 -49 0.00 -Z 0.00 -50 STD						ADD FOR OPTIONS: -C \$0.00 -52 \$159.00 -49 69.00 -92 242.00 -50 69.00 -Z 0.00 -51 159.00		
	30000-PD SECURITY BODY ASSEMBLY FOR PRISONS LIST PRICE					OPTION DESCRIPTIONS Strainers -CP Chrome Plated -J Backwater Valve -PF Perforated Standpipe -SC Solid Cover -SS Stainless Steel -VP Secured Grate, Vandal-Proof Screws -2 Satin Finish Bronze -24 Less Dome -63 Spanner Wrench -80 Perforated Stainless Steel Basket -92 Galvanized Cast Iron -93 Cast Iron Bodies Only -ARE Acid-Resisting Epoxy -C Bolted Flashing Clamp Device -MD PVC Clamp Collar with 3" Socket Connection -PD Prison Drain -ST Shallow Trap -49 3/4" Primer Tap -50 1/2" Primer Tap -51 1-1/2" Threaded Auxiliary Inlet -52 2" Threaded Auxiliary Inlet -91 Rough Bronze Body -92 Galvanized Cast Iron Parts Outlets -T Threaded Outlet -TSO Threaded Side Outlet -X Inside Caulk Outlet -Y Hub Outlet with Gasket -Z No-Hub Outlet		
	PIPE SIZE	30000-PD						
	2", 3"	\$326.00						
ADD FOR OPTIONS: -50 \$0.00 -T \$0.00 C 0.00								
	30000-TSO BODY ASSEMBLY WITH THREADED SIDE OUTLET LIST PRICE							
	PIPE SIZE	30000-TSO				PIPE SIZE	30000-TSO	
	2" - 4"	\$187.00						
ADD FOR OPTIONS: -ARE \$80.00 -92 \$90.00 -49 0.00 -TSO 0.00 -50 0.00								

ADJUSTABLE FLOOR DRAIN ASSEMBLIES

 NEW	30802-4CP		BODY WITH 2" SHALLOW TRAP & ROUND CHROME PLATED STRAINER		
	LIST PRICE				
	PIPE SIZE	30802-4CP			
	2"	\$250.00			
	ADD FOR OPTIONS:				
-SQ	\$30.00	-T	\$0.00		
-LT	Deduct 100.00			-Z	0.00

 NEW	30900-9AD		BODY WITH 9" ROUND NIKALOY STRAINER		
	LIST PRICE				
	PIPE SIZE	30900-9AD			
	2" - 4"	\$931.00			
	ADD FOR OPTIONS:				
-2	Deduct \$95.00			-T	\$36.00
-66 (2", 3")	100.00			-X	0.00
-66 (4")	143.00			-Y	0.00
-92	90.00			-Z	0.00
-VP	25.00				

 NEW	31000		BODY WITH 5" ROUND NIKALOY TOP		
	LIST PRICE				
	PIPE SIZE	31000			
	2" - 4"	\$175.00			
	ADD FOR OPTIONS:				
-SQ	\$75.00	-Y (2", 3")	\$0.00		
-C	15.00			-Z (3", 4")	0.00

FLOOR DRAINS

 NEW	32100		SUPER-FLO® 9" TOP		
	LIST PRICE				
	PIPE SIZE	32100			
	2" - 4"	\$232.00			
	ADD FOR OPTIONS:				
-AE	\$93.00	-13-2	\$320.00	-81	\$43.00
-TG	56.00	-15	112.00	-84	133.00
-LC1	606.00	-39	223.00	-88	19.00
-LC2	555.00	-VP	68.00	-92	196.00
-1	231.00	-ARE	237.00	-T	36.00
-2	197.00	-44*	129.00	-X	0.00
-7	108.00	-44 -92*	263.00	-Y	0.00
-11	29.00	-49	75.00	-Z	0.00
-13	38.00	-50	75.00		
-13-1	400.00	-66	198.00		
* Specify Height, Each 3" or Fraction					

 NEW	32150		SUPER-FLO® 9" BLOOD DRAIN	
	LIST PRICE			
	PIPE SIZE	32150		
	2" - 4"	\$694.00		
	ADD FOR OPTIONS:			
-1	\$1,273.00	-ARE	\$475.00	
-2	1,029.00	-T	36.00	
-7	250.00	-X	0.00	
-44*	169.00	-Y	0.00	
-44 -92*	385.00	-Z	0.00	
-92	389.00			
* Specify Height, Each 3" or Fraction				

32160



DEEP BODY, 9" TRACTOR TOP					
LIST PRICE					
PIPE SIZE	32160				
3", 4"	\$628.00				
ADD FOR OPTIONS:					
-7	\$87.00	-51	159.00	-62 (4")▲	302.00
-12	148.00	-52	\$159.00	-66	170.00
-15	112.00	-53	213.00	-71▲	\$87.00
-19	231.00	-54	213.00	-81▲	87.00
-20	192.00	-53 -92	243.00	-88▲	25.00
		-54 -92	243.00	-92	258.00
-44*	129.00	-60	282.00	-ARE	428.00
-49	69.00	-62 (3")▲	179.00	-VP	87.00
-50	69.00			-X	0.00
* Specify Height, Each 3" or Fraction ▲ Cannot be installed when BWW is ordered.					

32200



SHALLOW SUMP, SUPER-FLO® 12" TOP					
LIST PRICE					
PIPE SIZE	32200				
2" - 6" 8"	\$483.00 612.00				
ADD FOR OPTIONS:					
-AE	\$195.00	-13 -1	\$571.00	-50	\$69.00
-81	211.00	-13 -2	489.00	-66 •	170.00
-SD	43.00	-15	109.00	-84	192.00
-1	345.00	-ARE	386.00	-88	29.00
-2	299.00	-VP	68.00	-92	296.00
-4*	86.00	-44**	114.00	-T	36.00
-7	119.00	-44 -92**	230.00	-X	0.00
-13	63.00	-49	69.00	-Y	0.00
				-Z	0.00
* Available on -AE Only ** Specify Height, Each 3" or Fraction • 2"-6"					

32300







MEDIUM SUMP, SUPER-FLO® 12" TOP					
LIST PRICE					
PIPE SIZE	32300				
2" - 8"	\$585.00				
ADD FOR OPTIONS:					
-81	\$115.00	-13 -2	\$489.00	-50	\$69.00
-SD	71.00	-15	109.00	-66 •	170.00
-1	345.00	-ARE	441.00	-84	192.00
-2	299.00	-VP	68.00	-88	29.00
-7	119.00	-44*	114.00	-92	296.00
-13	63.00	-44 -92*	230.00	-X	0.00
-13 -1	571.00	-49	69.00	-Z	0.00
* Specify Height, Each 2" or Fraction • 2"-6"					

32330



DEEP SUMP, SUPER-FLO® 12" TOP w/BUCKET			
LIST PRICE			
PIPE SIZE	32330		
2" - 6" 8"	\$819.00 959.00		
ADD FOR OPTIONS:			
-SD	\$0.00	-50	\$75.00
-15	109.00	-66 •	170.00
-VP	68.00	-70	Deduct 139.00
-19	332.00	-84	187.00
-20	287.00	-88	43.00
-44*	103.00	-92	553.00
-44 -92*	209.00	-X	0.00
-49	75.00	-Z	0.00
* On -SD Only, Specify Height, Per Inch • 2"-6"			

	15" EXTRA HEAVY-DUTY TOP	
	LIST PRICE	
	PIPE SIZE	34710
	4"	\$719.00
	5", 6"	851.00
	8"	1,016.00
ADD FOR OPTIONS:		
-AE	\$326.00	-20..... \$737.00
-7.....	282.00	-49..... 69.00
-15.....	109.00	-50..... 69.00
-VP	66.00	-88..... 43.00
-19.....	843.00	-92..... 409.00
-ARE		\$426.00
-T.....		36.00
-X		0.00
-Y		0.00
-Z.....		0.00
	15" EXTRA HEAVY-DUTY TOP WITH BUCKET	
	LIST PRICE	
	PIPE SIZE	34720
	3" - 6"	\$1,348.00
ADD FOR OPTIONS:		
-7.....	\$302.00	-49..... \$69.00
-15.....	109.00	-50..... 69.00
-VP	95.00	-66..... 170.00
-19.....	843.00	-84..... 192.00
-20.....	737.00	-88..... 43.00
-92.....		\$905.00
-X		0.00
-Z.....		0.00
	NON-CLOG 21" ROUND TOP WITH BUCKET	
	LIST PRICE	
	PIPE SIZE	34920
	3" - 8"	\$7,022.00
ADD FOR OPTIONS:		
-12.....	*P.O.A.	-19..... 903.00
-12 -1	*P.O.A.	-20..... \$753.00
-12 -2	*P.O.A.	-C
-15.....	\$109.00	-49..... 69.00
-VP	95.00	-50..... 69.00
-66•		170.00
-80.....		1,288.00
-84.....		\$258.00
-92.....		1,351.00
-T.....		36.00
-X		0.00
* PRICE ON APPLICATION • 2"-6"		
	8" SQUARE TOP	
	LIST PRICE	
	PIPE SIZE	35100
	2" - 4"	\$379.00
ADD FOR OPTIONS:		
-TSO	\$100.00	-49..... \$75.00
-1.....	282.00	-50..... STD
-2.....	209.00	-92..... 193.00
-7.....	96.00	-ARE
-15.....	109.00	-T..... 36.00
-X		0.00
-Y		0.00
-Z.....		0.00
	9" TOP WITH BUCKET	
	LIST PRICE	
	PIPE SIZE	35130
	2" - 4"	\$442.00
ADD FOR OPTIONS:		
-1.....	\$287.00	-VP
-2.....	209.00	-49..... 69.00
-14 -1	757.00	-50..... 69.00
-14 -2	716.00	-66..... 71.00
-15.....	112.00	-70... Deduct 36.00
-84.....		\$95.00
-92.....		195.00
-ARE		338.00
-X		0.00
-Z.....		0.00

OPTION DESCRIPTIONS











- AE LEVELEZE® Adjustable Extension
- ARE Acid Resisting Epoxy
- C Bolted Flashing Clamp Device
- LC1 Locking Cover, Satin Finish Nikaloy
- LC2 Locking Cover, Satin Finish Bronze
- LT Less Shallow Trap
- SD Special Duty Grate
- SQ Square Top
- TG Tractor Grate
- VP Secured Grate, Vandal-Proof Screws
- 1 Satin Finish Nikaloy Top
- 2 Satin Finish Bronze Top
- 4 Secondary Flashing Clamp (use with -AE only)
- 7 Ductile Iron Grate
- 11 Extra-Heavy Grate, Cast Iron
- 12 Square Top, Cast Iron
- 12-1 Square Top, Nikaloy
- 12-2 Square Top, Bronze
- 13 Dome Grate, Cast Iron
- 13-1 Dome Grate, Nikaloy
- 13-2 Dome Grate, Bronze
- 14-1 Hinged Top, Satin Finish Nikaloy
- 14-2 Hinged Top, Satin Finish Bronze
- 15 Chained Grate
- 19 C.I. Undergrate with Satin Finish Nikaloy Top
- 20 C.I. Undergrate with Satin Finish Bronze Top
- 39 Solid Cast Iron Cover
- 44 Fixed Extension Collar, Cast Iron, Specify Height
- 44-92 Fixed Extension Collar, Galvanized, Specify Height
- 49 3/4" Primer Tap
- 50 1/2" Primer Tap
- 51 1-1/2" Auxiliary Threaded Inlet
- 52 2" Auxiliary Threaded Inlet
- 53 2" Auxiliary Hub Inlet
- 54 2" Auxiliary Spigot Inlet
- 53-92 2" Auxiliary Hub Inlet, Galvanized
- 54-92 2" Auxiliary Spigot Inlet, Galvanized
- 60 Backwater Valve
- 62 "T" Handle Bronze Closure Plug
- 70 Less Bucket
- 71 Solid Cast Iron Bucket
- 81 Slotted Cast Iron Bucket
- 84 Stainless Steel Mesh Bucket Liner
- 88 Supplementary Strainer
- 92 Galvanized Cast Iron Parts







Outlets

- 66 No-Hub Side Outlet
- T Threaded Outlet
- TSO Threaded Side Outlet
- X Inside Caulk Outlet
- Y Hub Outlet with Gasket, 2" - 4"
- Z No-Hub Outlet

FLOOR DRAINS



35170 	10" TRACTOR TOP WITH BUCKET LIST PRICE		37840 	12" TOP WITH BUCKET LIST PRICE	
	PIPE SIZE 3", 4"	35170 \$532.00		PIPE SIZE 2" - 8"	37840 \$1,360.00
ADD FOR OPTIONS:			ADD FOR OPTIONS:		
-1..... \$442.00 -49..... \$75.00 -88..... \$25.00 -2..... 373.00 -50..... 75.00 -92..... 158.00 -15..... 109.00 -70.. Deduct 44.00 -X 0.00 -VP 69.00 -84..... 125.00 -Z..... 0.00			-7..... \$277.00 -49..... \$69.00 -88..... \$43.00 -14..... 109.00 -50..... 69.00 -92..... 409.00 -VP 66.00 -66..... 170.00 -X 0.00 -19..... 505.00 -70.. Deduct 76.00 -Z..... 0.00 -20..... 418.00 -84..... 192.00		
37800 	SHALLOW SUMP, 12" HEAVY-DUTY TOP LIST PRICE		37900 	14" PACKING HOUSE DRAIN LIST PRICE	
	PIPE SIZE 2" - 4"	37800 \$644.00		PIPE SIZE 2" - 6" 8"	37900 \$1,360.00 1,533.00
ADD FOR OPTIONS:			ADD FOR OPTIONS:		
-7..... \$269.00 -20..... \$418.00 -T..... \$36.00 -14..... 109.00 -49..... 75.00 -X 0.00 -VP 66.00 -50..... STD -Y 0.00 -18..... 253.00 -66..... 99.00 -Z..... 0.00 -19..... 505.00 -92..... 227.00			-4..... \$86.00 -70. Deduct \$84.00 -X \$0.00 -15..... 112.00 -84..... 192.00 -Y 0.00 -VP 68.00 -88..... 35.00 -Z..... 0.00 -19..... 618.00 -92..... 778.00 -20..... 589.00 -T..... 36.00		
37810 	MEDIUM SUMP, 12" HEAVY-DUTY TOP LIST PRICE		37960 	SUPER-FLO® 16" TOP LIST PRICE	
	PIPE SIZE 2" - 6"	37810 \$685.00		PIPE SIZE 2" - 6"	37960 \$1,170.00
ADD FOR OPTIONS:			ADD FOR OPTIONS:		
-AE \$326.00 -19..... \$505.00 -88..... 43.00 -4* 86.00 -20..... 418.00 -92..... 409.00 -7..... 277.00 -49..... 69.00 -ARE 423.00 -14..... 109.00 -50..... 69.00 -T..... 36.00 -VP 66.00 -66..... 170.00 -X 0.00 -18..... 253.00 -70.. Deduct 76.00 -Y 0.00 * Available on -AE only -84..... \$192.00 -Z..... 0.00			-1..... \$1,355.00 -15..... \$112.00 -92..... \$579.00 -2..... 1,217.00 -LF Deduct 171.00 -92-LF 487.00 -7..... 279.00 -C 258.00 -92-LG-LF . 442.00 -LG Deduct 260.00 -49..... 87.00 -ARE See 49400 -LG-1 Ded. 544.00 -50..... 87.00 -X 0.00 -LG-2 Ded. 506.00 -81 270.00 -11..... 279.00 -84..... 192.00		
37820 	DEEP SUMP, 12" HEAVY-DUTY TOP WITH BUCKET LIST PRICE		38040 	ROUND TOP & CLEANOUT LIST PRICE	
	PIPE SIZE 2" - 8"	37820 \$786.00		PIPE SIZE 2" 3" 4"	38040 \$578.00 908.00 953.00
ADD FOR OPTIONS:			ADD FOR OPTIONS:		
-AE \$326.00 -19..... \$505.00 -84..... \$192.00 -4* 86.00 -20..... 418.00 -88..... 43.00 -7..... 277.00 -49..... 69.00 -92..... 409.00 -14..... 109.00 -50..... 69.00 -ARE 448.00 -VP 66.00 -66 • 170.00 -X 0.00 -18..... 253.00 -70.. Deduct 76.00 -Z..... 0.00 * Available on -AE only • 2"-6"			-1..... \$351.00 -50..... \$69.00 -81-92 \$96.00 -2..... 321.00 -51..... 159.00 -84..... 133.00 -7..... 115.00 -52..... 159.00 -88..... 19.00 -11..... 29.00 -60 (2") 276.00 -92..... 345.00 -15..... 108.00 -60 (3") 305.00 -Z..... 0.00 -VP 66.00 -60 (4") 332.00 -49..... 69.00 -81..... 57.00		
37830 	12" TOP WITH LATCHING GRATE LIST PRICE		38250A 	ROUND TOP WITH CLEANOUT & BWV LIST PRICE	
	PIPE SIZE 2" - 6"	37830 \$937.00		PIPE SIZE 2" 3" 4"	38250A \$389.00 534.00 750.00
ADD FOR OPTIONS:			ADD FOR OPTIONS:		
-7..... \$277.00 -49..... \$69.00 -92..... \$409.00 -19..... 505.00 -50..... 69.00 -X 0.00 -20..... 418.00 -66..... 170.00 -Z..... 0.00 -21. Deduct 216.00 -69..... 36.00 -22. Deduct 143.00 -84..... 192.00			-1 (2" - 3")..... \$190.00 -VP \$66.00 -1 (4") 448.00 -61 (2") Deduct 43.00 -2 (2" - 3")..... 171.00 -61 (3", 4") Deduct 88.00 -2 (4") 404.00 -92..... 224.00 -15..... 109.00 -Z..... 0.00		

38420 	NON-CLOG WITH CLEANOUT & BUCKET LIST PRICE		38850 	22" X 14" TOP, INTERNAL DOME STRAINER LIST PRICE	
	PIPE SIZE 3", 4"	38420 \$7,346.00		PIPE SIZE 3" - 6"	38850 \$2,825.00
ADD FOR OPTIONS: -IGS..... \$8,746.00 -C \$244.00 -1..... 1,835.00 -60..... 448.00 -2..... 1,650.00 -84..... 192.00 -15..... 112.00 -92..... 1,596.00 -VP 109.00		ADD FOR OPTIONS: -7..... \$908.00 -92..... \$1,515.00 -15..... 112.00 -X 0.00 -VP 109.00			
38620-40 	13" X 11" TOP WITH HINGED GRATE LIST PRICE		38930 	21" X 14 1/2" TOP, CLEANOUT & BUCKET LIST PRICE	
	PIPE SIZE 3" 4"	38620-40 \$2,250.00 2,481.00		PIPE SIZE 3", 4"	38930 \$1,634.00
ADD FOR OPTIONS: -1 (3") \$676.00 -33..... 170.00 -84..... 192.00 -1 (4") 734.00 -49..... 69.00 -92..... 878.00 -2 (3") 548.00 -50..... 69.00 -2 (4") 605.00 -60 (3") 306.00 -7..... 279.00 -60 (4") .. \$333.00 -VP \$66.00 -70.. Deduct 76.00		ADD FOR OPTIONS: -7..... \$282.00 -92..... 735.00 -15..... 112.00 -X 0.00 -VP 68.00 -C 180.00 -84..... \$192.00			
38640 	13" X 11" TOP WITH BUCKET LIST PRICE		OPTION DESCRIPTIONS -AE LEVELEZE® Adjustable Extension -ARE Acid Resisting Epoxy -C Bolted Flashing Clamp Device -IGS Internal Gas Seal -LF Less Double Drainage Flange -LG Less Grate, Cast Iron -LG-1 Less Grate, Nikaloy -LG-2 Less Grate, Bronze -VP Secured Grate, Vandal-Proof Screws -1 Satin Finish Nikaloy Top -2 Satin Finish Bronze Top -4 Secondary Flashing Clamp (use with -AE only) -7 Ductile Iron Grate -11 Extra-Heavy Grate, Cast Iron -14 Hinged Grate -15 Chained Grate -18 Hinged Grate with Latching Device -19 C.I. Undergrate with Satin Finish Nikaloy Top -20 C.I. Undergrate with Satin Finish Bronze Top -21 Loose-Set Grate -22 Less Latching Device -33 Galvanized Bucket Only -49 3/4" Primer Tap -50 1/2" Primer Tap -51 1-1/2" Auxiliary Threaded Inlet -52 2" Auxiliary Threaded Inlet -60 Backwater Valve -61 Less Backwater Valve -69 Lift Handle for Sediment Bucket -70 Less Bucket -74 Aluminum Bucket -81 Slotted Cast Iron Bucket -81-92 Slotted Cast Iron Bucket, Galvanized -84 Stainless Steel Mesh Bucket Liner -88 Supplementary Strainer -92 Galvanized Cast Iron Parts -92-LF Galv. C.I. Parts, Less Double Drainage Flange -92-LG-LF Galv. C.I. Parts, Less Grate and Flange Outlets -66 No-Hub Side Outlet -T Threaded Outlet -X Inside Caulk Outlet -Y Hub Outlet with Gasket, 2" - 4" -Z No-Hub Outlet		
	PIPE SIZE 2" - 4"	38640 \$1,025.00			
ADD FOR OPTIONS: -1..... \$617.00 -70..... Deduct \$73.00 -2..... 512.00 -84..... 192.00 -7..... 282.00 -92..... 459.00 -VP 68.00					
38820 	15" X 13" TOP, TRACTOR GRATE LIST PRICE				
	PIPE SIZE 3", 4"	38820 \$1,590.00			
ADD FOR OPTIONS: -1..... \$674.00 -49..... \$69.00 -84..... \$192.00 -2..... 608.00 -50..... 69.00 -92..... 427.00 -7..... 277.00 -66..... 170.00 -X 0.00 -15..... 112.00 -74..... 171.00 -Z..... 0.00					
38830 	13-3/4" X 14-1/8" TOP WITH HINGED GRATE LIST PRICE				
	PIPE SIZE 3", 4"	38830 \$1,700.00			
ADD FOR OPTIONS: -1..... \$505.00 -49..... \$69.00 -2..... 376.00 -50..... 69.00 -7..... 282.00 -84..... 192.00 -VP 66.00 -92..... 671.00					

	SQUARE CAN WASH DRAIN LIST PRICE			CAST STAINLESS STEEL ADJUSTABLE FLOOR DRAIN WITH ROUND SUPER-FLO® STRAINER LIST PRICE	
	PIPE SIZE	39240		PIPE SIZE	30000-A-SS-T
	3" - 4"	\$1,297.00	2"	POA*	
ADD FOR OPTIONS: -1..... \$365.00 -C..... \$0.00 -92..... \$475.00 -2..... 321.00 -66..... 170.00 -X..... 0.00 -15..... 112.00 -84..... 216.00 -Z..... 0.00			3"	POA*	
	PLANTING AREA DRAIN LIST PRICE		4"	POA*	
	PIPE SIZE	39600	ADD FOR OPTIONS: -5A-SS..... *POA -8A-SS..... *POA -80..... *POA -6A-SS..... *POA -VP..... *POA -T..... 0.00 -7A-SS..... *POA -50..... *POA		
2" - 6"	\$502.00		* PRICE ON APPLICATION		
ADD FOR OPTIONS: -66..... \$170.00 -92..... \$180.00 -X..... \$0.00 -89..... 69.00 -T..... 36.00 -Z..... 0.00				ADJUSTABLE FLOOR DRAIN WITH SQUARE SUPER-FLO® STRAINER LIST PRICE	
	11" TOP COMPOSITION DECK FLANGE LIST PRICE			PIPE SIZE	30000-S-SS-T
	PIPE SIZE	39720	2"	POA*	
2" - 4"	\$928.00		3"	POA*	
ADD FOR OPTIONS: -1..... \$347.00 -13-1..... \$571.00 -70...Ded. \$143.00 -2..... 302.00 -13-2..... 489.00 -92..... 418.00 -7..... 121.00 -15..... 112.00 -T..... 36.00 -13..... 63.00 -VP..... 68.00 -X..... 0.00			4"	POA*	
	8" SQUARE TOP WITH HINGED GRATE LIST PRICE		ADD FOR OPTIONS: -5S-SS..... *POA -VP..... *POA -80..... *POA -6S-SS..... *POA -50..... *POA -T..... 0.00 -8S-SS..... *POA		
	PIPE SIZE	39960	* PRICE ON APPLICATION		
2"	\$175.00		ROUND SUPER-FLO® TOP WITH ADJUSTABLE EXTENSION LIST PRICE		
3"	213.00		PIPE SIZE	32100-SS-AE	
4"	365.00		2"	POA*	
ADD FOR OPTIONS: -VP..... \$68.00 -92..... \$150.00 -ARE..... 184.00 -X..... 0.00			3"	POA*	
Floor Drain OPTION DESCRIPTIONS -ARE Acid Resisting Epoxy -C Bolted Flashing Clamp Device -VP Secured Grate, Vandal-Proof Screws -1 Satin Finish Nikaloy Top -2 Satin Finish Bronze Top -7 Ductile Iron Grate -13 Dome Grate, Cast Iron -13-1 Dome Grate, Nikaloy -13-2 Dome Grate, Bronze -15 Chained Grate -70 Less Bucket -84 Stainless Steel Mesh Bucket Liner -89 Deck Clamp Assembly -92 Galvanized Cast Iron Parts Outlets -66 No-Hub Side Outlet -T Threaded Outlet -X Inside Caulk Outlet -Z No-Hub Outlet				ADD FOR OPTIONS: -1..... *POA -22..... *POA -61..... *POA -8..... *POA -25..... *POA -69..... STD -9..... *POA -26..... *POA -81..... *POA -21..... *POA -34..... *POA	
				* PRICE ON APPLICATION	
32200-SS ROUND 12" TOP LIST PRICE				CLEANOUT LIST PRICE	
				PIPE SIZE	32200-SS
ADD FOR OPTIONS: -8..... *POA -25..... *POA -61..... *POA -9..... *POA -26..... *POA -69..... STD -22..... *POA -34..... *POA			3"	POA*	
			4"	POA*	
ADD FOR OPTIONS: -45..... *POA -67..... *POA -69..... STD * PRICE ON APPLICATION			6"	POA*	

Cast Stainless Steel OPTION DESCRIPTIONS

- 5A-SS 5" Round Stainless Steel Strainer
 - 6A-SS 6" Round Stainless Steel Strainer
 - 7A-SS 7" Round Stainless Steel Strainer
 - 8A-SS 8" Round Stainless Steel Strainer
 - 5S-SS 5" Square Stainless Steel Strainer
 - 6S-SS 6" Square Stainless Steel Strainer
 - 8S-SS 8" Square Stainless Steel Strainer
 - VP Secured Grate, Vandal-Proof Screws
 - 1 Satin Finish Nikaloy Grate
 - 8 Solid Cover (Specify Material)
 - 9 Stainless Steel Mesh Screen on Underside of Grate
 - 21 4" Diameter Funnel (Same Material as Grate)
 - 22 6" Diameter Funnel (Same Material as Grate)
 - 25 Type 304 Stainless Steel Recessed Closure Plug
 - 26 Molded ABS Recessed Closure Plug
 - 34 "T" Handle for Recessed Plug
 - 45 Spanner Wrench
 - 50 1/2" Primer Tap
 - 61 Flashing Clamp Device
 - 80 Perforated Stainless Steel Basket
 - 81 Shallow Stainless Steel Sediment Bucket
- Outlets:**
- 69 Schedule 10 S Butt Weld Connection
 - T Threaded Outlet

FABRICATED STAINLESS STEEL

40300



NEW

FLOOR DRAIN/FLOOR SINK, 8" X 8" PERFORATED GRATE

LIST PRICE

PIPE SIZE	Nom. 3", 4"	POA*
-----------	-------------	------

ADD FOR OPTIONS:

-MD..... *POA	-B..... *POA
-PF..... *POA	-SO..... *POA
-XHD..... *POA	-WT..... *POA
-CG..... *POA	-Z**..... *POA

* PRICE ON APPLICATION
** No-Hub with Transitional Coupling

40320



NEW

FLOOR DRAIN/FLOOR SINK, 12" X 12" PERFORATED GRATE, 6" DEEP

LIST PRICE

PIPE SIZE	2", 3", 4"	POA*
-----------	------------	------

ADD FOR OPTIONS:

-MD..... *POA	-3Q..... \$0.00
-PF..... *POA	-B..... *POA
-XHD..... *POA	-Y (2", 3")..... *POA
-CG..... *POA	-Z (3", 4")..... *POA
-HG..... \$0.00	

*PRICE ON APPLICATION Will Be Available 2009

40340



NEW

FLOOR DRAIN/FLOOR SINK, 12" X 12" PERFORATED GRATE, 8" DEEP

LIST PRICE

PIPE SIZE	2", 3", 4"	POA*
-----------	------------	------

ADD FOR OPTIONS:

-MD..... *POA	-3Q..... \$0.00
-PF..... *POA	-B..... *POA
-XHD..... *POA	-Y (2", 3")..... *POA
-CG..... *POA	-Z (3", 4")..... *POA
-HG..... \$0.00	

*PRICE ON APPLICATION Will Be Available 2009

40460

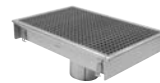

NEW

20" X 20" KETTLE DRAIN WITH MESH GRATE

LIST PRICE

PIPE SIZE	Nom. 4", 6"	POA*
-----------	-------------	------

ADD FOR OPTIONS:

-B..... *POA	-Z**..... *POA
-WT..... *POA	

* PRICE ON APPLICATION
** No-Hub with Transitional Coupling

40520



NEW

FLOOR DRAIN/FLOOR SINK, 8" ROUND PERFORATED GRATE

LIST PRICE

PIPE SIZE	Nom. 3", 4"	POA*
-----------	-------------	------

ADD FOR OPTIONS:

-MD..... *POA	-B..... *POA
-PF..... *POA	-SO..... *POA
-XHD..... *POA	-WT..... *POA
-CG..... *POA	-Z**..... *POA

* PRICE ON APPLICATION
** No-Hub with Transitional Coupling

40580



NEW

FLOOR DRAIN/FLOOR SINK, 12" ROUND PERFORATED GRATE

LIST PRICE

PIPE SIZE	Nom. 3", 4"	POA*
-----------	-------------	------

ADD FOR OPTIONS:

-MD..... *POA	-B..... *POA
-PF..... *POA	-SO..... *POA
-XHD..... *POA	-WT..... *POA
-CG..... *POA	-Z**..... *POA

* PRICE ON APPLICATION
** No-Hub with Transitional Coupling

Fabricated Stainless Steel OPTION DESCRIPTIONS







- B Stainless Steel Bucket
- CG Cast Stainless Steel Grate
- HG Half Grate, Perforated Stainless Steel
- MD Medium-Duty Mesh Grate
- PF Heavy-Duty Perimeter Slot Grate
- WT With Trap
- XHD Extra Heavy-Duty Bar Grate
- 3Q 3/4 Grate, Perforated Stainless Steel





Outlets:



- SO Side Outlet
- Y Hub Outlet with Gasket
- Z No-Hub Outlet

SANITARY FLOOR SINKS



	49300 SUPER-FLO® 8" SQUARE TOP, 6" DEE					12" SQUARE TOP, 10" DEEP			
	LIST PRICE					LIST PRICE			
	PIPE SIZE 2" - 4"	49300 \$809.00	49300 -LF \$725.00	49300 -NB \$1,006.00		49300 -LF-NB \$922.00	PIPE SIZE 2" - 4"	49360A \$1,258.00	49360A -LF \$1,081.00
ADD FOR OPTIONS:					ADD FOR OPTIONS:				
-LF Deduct \$84.00 -18 (ARE) \$243.00 -NB 197.00 -18 (NB) 405.00 -LG (ARE) Deduct 87.00 -20 (NB) 103.00 -LG (NB) Deduct 139.00 -24 (NB) 99.00 -3 0.00 -31 92.00 -4 0.00 -33 197.00 -7 81.00 -35* 216.00 -8 87.00 -43 144.00 -VP (NB) 35.00 -45 Deduct 27.00 -16 (ARE) 174.00 -55** 87.00 -16 (NB) 195.00 -C 68.00 -17 (ARE) 224.00 -X 0.00 -17 (NB) 288.00 -Z 0.00					-LF Deduct \$177.00 -17 (NB) \$288.00 -NB 347.00 -18 (ARE) 243.00 -LG (ARE) Deduct 104.00 -18 (NB) 405.00 -LG (NB) Deduct 226.00 -20 (NB) 103.00 -3 0.00 -24 (NB) 99.00 -4 0.00 -31 144.00 -5 501.00 -32 144.00 -7 81.00 -33 276.00 -8 87.00 -35* 216.00 -VP (NB) 35.00 -43 155.00 -15 1,611.00 -45 Deduct 27.00 -16 (ARE) 174.00 -55** 87.00 -16 (NB) 195.00 -C 86.00 -17 (ARE) 224.00 -X 0.00 -17 (NB) 288.00 -Y 0.00 -Z 0.00				
* Specify -31 or -33 Bucket ** 88450 Provided					* Specify -31 or -33 Bucket ** 88450 Provided				
	49320A 12" SQUARE TOP, 6" DEEP					SUPER-FLO® 16" SQUARE TOP, 6" DEEP			
	LIST PRICE					LIST PRICE			
	PIPE SIZE 2", 3" 4", 6"	49320A \$1,150.00	49320A -LF \$973.00	49320A -NB \$1,497.00		49320A -LF-NB \$1,320.00	PIPE SIZE 3", 4", 6"	49400 \$2,160.00	49400 -LF \$1,990.00
ADD FOR OPTIONS:					ADD FOR OPTIONS:				
-LF (2" - 4") . Deduct \$177.00 -17 (NB) \$288.00 -NB 347.00 -18 (ARE) 243.00 -LG (ARE) Deduct 104.00 -18 (NB) 405.00 -LG (NB) Deduct 226.00 -20 (NB) 103.00 -3 0.00 -24 (NB) 99.00 -4 0.00 -31 144.00 -5 501.00 -33 276.00 -7 81.00 -35* 216.00 -8 87.00 -43 155.00 -VP (NB) 35.00 -45 Deduct 27.00 -15 1,611.00 -55** 87.00 -16 (ARE) 174.00 -C 86.00 -16 (NB) 195.00 -X 0.00 -17 (ARE) 224.00 -Y (2" - 4") 0.00 -Z 0.00					-LF Deduct \$170.00 -18 (ARE) \$243.00 -NB 561.00 -18 (NB) 404.00 -LG (ARE) Deduct 172.00 -31 382.00 -LG (NB) Deduct 478.00 -33 1,075.00 -3 0.00 -35* 432.00 -4 0.00 -43 144.00 -7 81.00 -45 Deduct 27.00 -VP (NB) 35.00 -51 See 37960 Series -16 (ARE) 174.00 -52 See 37960 Series -16 (NB) 195.00 -55** 87.00 -17 (ARE) 224.00 -C 258.00 -17 (NB) 288.00 -X 0.00				
* Specify -31 or -33 Bucket ** 88450 Provided for 2" - 4" Body Primer Tapped for 6".					* Specify -31 or -33 Bucket ** 88450 Provided for 3" & 4". Body Primer Tapped for 6".				
	49340A 12" SQUARE TOP, 8" DEEP					SUPER-FLO® 16" SQUARE TOP, 12" DEEP			
	LIST PRICE					LIST PRICE			
	PIPE SIZE 2" - 4"	49340A \$1,198.00	49340A -LF \$1,021.00	49340A -NB \$1,545.00		49340A -LF-NB \$1,368.00	PIPE SIZE 3", 4", 6"	49420 \$2,160.00	49420 -LF \$1,930.00
ADD FOR OPTIONS:					ADD FOR OPTIONS:				
-LF Ded. \$177.00 -17 (ARE) \$224.00 -NB 347.00 -17 (NB) 288.00 -LG (ARE) Deduct 104.00 -18 (ARE) 243.00 -LG (NB) Deduct 226.00 -18 (NB) 405.00 -3 0.00 -20 (NB) 103.00 -4 0.00 -24 (NB) 99.00 -5 501.00 -31 144.00 -7 81.00 -33 276.00 -8 87.00 -35* 216.00 -VP (NB) 35.00 -43 155.00 -15 1,611.00 -45 Deduct 27.00 -16 (ARE) 174.00 -55** 87.00 -16 (NB) 195.00 -C 86.00 -17 (ARE) 224.00 -X 0.00 -17 (NB) 288.00 -Y 0.00 -Z 0.00					-LF Deduct \$230.00 -18 (ARE) \$243.00 -NB 561.00 -18 (NB) 404.00 -LG (ARE) Deduct 172.00 -31 382.00 -LG (NB) Deduct 478.00 -33 1,075.00 -3 0.00 -35* 432.00 -4 0.00 -43 144.00 -7 81.00 -45 Deduct 27.00 -VP (NB) 35.00 -51 0.00 -16 (ARE) 174.00 -52 Deduct 172.00 -16 (NB) 195.00 -55** 87.00 -17 (ARE) 224.00 -C 258.00 -17 (NB) 288.00 -X 0.00				
* Specify -31 or -33 Bucket ** 88450 Provided					* Specify -31 or -33 Bucket ** 88450 Provided for 3" & 4". Body Primer Tapped for 6".				

<p>49500</p> 	<p>SUPER-FLO® 8" ROUND TOP, 3" DEEP</p> <table border="1"> <thead> <tr> <th colspan="5">LIST PRICE</th> </tr> <tr> <th>PIPE SIZE</th> <th>49500</th> <th>49500 -LF</th> <th>49500 -NB</th> <th>49500 -LF-NB</th> </tr> </thead> <tbody> <tr> <td>2" - 4"</td> <td>\$718.00</td> <td>\$587.00</td> <td>\$831.00</td> <td>\$700.00</td> </tr> </tbody> </table> <p>ADD FOR OPTIONS:</p> <table> <tr> <td>-LF</td> <td>Deduct \$131.00</td> <td>-18 (ARE).....</td> <td>\$243.00</td> </tr> <tr> <td>-NB</td> <td>113.00</td> <td>-18 (NB)</td> <td>404.00</td> </tr> <tr> <td>-LG (ARE)</td> <td>Deduct 87.00</td> <td>-31.....</td> <td>103.00</td> </tr> <tr> <td>-LG (NB)</td> <td>Deduct 95.00</td> <td>-33.....</td> <td>249.00</td> </tr> <tr> <td>-3.....</td> <td>0.00</td> <td>-35*</td> <td>216.00</td> </tr> <tr> <td>-4.....</td> <td>0.00</td> <td>-43.....</td> <td>144.00</td> </tr> <tr> <td>-7.....</td> <td>81.00</td> <td>-45.....</td> <td>Deduct 27.00</td> </tr> <tr> <td>-8.....</td> <td>86.00</td> <td>-51.....</td> <td>0.00</td> </tr> <tr> <td>-VP (NB)</td> <td>35.00</td> <td>-52.....</td> <td>Deduct 81.00</td> </tr> <tr> <td>-16 (ARE).....</td> <td>174.00</td> <td>-55**</td> <td>87.00</td> </tr> <tr> <td>-16 (NB)</td> <td>195.00</td> <td>-C</td> <td>86.00</td> </tr> <tr> <td>-17 (ARE).....</td> <td>224.00</td> <td>-X</td> <td>0.00</td> </tr> <tr> <td>-17 (NB)</td> <td>288.00</td> <td></td> <td></td> </tr> </table> <p>* Specify -31 or -33 Bucket ** 88450 Provided</p>	LIST PRICE					PIPE SIZE	49500	49500 -LF	49500 -NB	49500 -LF-NB	2" - 4"	\$718.00	\$587.00	\$831.00	\$700.00	-LF	Deduct \$131.00	-18 (ARE).....	\$243.00	-NB	113.00	-18 (NB)	404.00	-LG (ARE)	Deduct 87.00	-31.....	103.00	-LG (NB)	Deduct 95.00	-33.....	249.00	-3.....	0.00	-35*	216.00	-4.....	0.00	-43.....	144.00	-7.....	81.00	-45.....	Deduct 27.00	-8.....	86.00	-51.....	0.00	-VP (NB)	35.00	-52.....	Deduct 81.00	-16 (ARE).....	174.00	-55**	87.00	-16 (NB)	195.00	-C	86.00	-17 (ARE).....	224.00	-X	0.00	-17 (NB)	288.00			<p>49700</p> 	<p>4" X 8" RECTANGULAR TOP, 4" DEEP</p> <table border="1"> <thead> <tr> <th colspan="5">LIST PRICE</th> </tr> <tr> <th>PIPE SIZE</th> <th>49700</th> <th>49700 -LF</th> <th>49700 -NB</th> <th>49700 -LF-NB</th> </tr> </thead> <tbody> <tr> <td>2", 3"</td> <td>\$837.00</td> <td>\$750.00</td> <td>\$987.00</td> <td>\$900.00</td> </tr> </tbody> </table> <p>ADD FOR OPTIONS:</p> <table> <tr> <td>-LF</td> <td>Deduct \$87.00</td> <td>-30.....</td> <td>216.00</td> </tr> <tr> <td>-NB</td> <td>150.00</td> <td>-43.....</td> <td>144.00</td> </tr> <tr> <td>-LG (ARE)</td> <td>Deduct 69.00</td> <td>-45.....</td> <td>Deduct 27.00</td> </tr> <tr> <td>-LG (NB)</td> <td>Deduct 138.00</td> <td>-51.....</td> <td>0.00</td> </tr> <tr> <td>-3.....</td> <td>0.00</td> <td>-52.....</td> <td>Deduct 76.00</td> </tr> <tr> <td>-4.....</td> <td>0.00</td> <td>-55*</td> <td>87.00</td> </tr> <tr> <td>-7.....</td> <td>81.00</td> <td>-C</td> <td>86.00</td> </tr> <tr> <td>-8.....</td> <td>87.00</td> <td>-X</td> <td>0.00</td> </tr> <tr> <td>-VP (NB)</td> <td>35.00</td> <td></td> <td></td> </tr> <tr> <td>-16 (ARE).....</td> <td>174.00</td> <td></td> <td></td> </tr> <tr> <td>-16 (NB)</td> <td>\$195.00</td> <td></td> <td></td> </tr> </table> <p>* 88450 Provided</p>	LIST PRICE					PIPE SIZE	49700	49700 -LF	49700 -NB	49700 -LF-NB	2", 3"	\$837.00	\$750.00	\$987.00	\$900.00	-LF	Deduct \$87.00	-30.....	216.00	-NB	150.00	-43.....	144.00	-LG (ARE)	Deduct 69.00	-45.....	Deduct 27.00	-LG (NB)	Deduct 138.00	-51.....	0.00	-3.....	0.00	-52.....	Deduct 76.00	-4.....	0.00	-55*	87.00	-7.....	81.00	-C	86.00	-8.....	87.00	-X	0.00	-VP (NB)	35.00			-16 (ARE).....	174.00			-16 (NB)	\$195.00		
LIST PRICE																																																																																																																																	
PIPE SIZE	49500	49500 -LF	49500 -NB	49500 -LF-NB																																																																																																																													
2" - 4"	\$718.00	\$587.00	\$831.00	\$700.00																																																																																																																													
-LF	Deduct \$131.00	-18 (ARE).....	\$243.00																																																																																																																														
-NB	113.00	-18 (NB)	404.00																																																																																																																														
-LG (ARE)	Deduct 87.00	-31.....	103.00																																																																																																																														
-LG (NB)	Deduct 95.00	-33.....	249.00																																																																																																																														
-3.....	0.00	-35*	216.00																																																																																																																														
-4.....	0.00	-43.....	144.00																																																																																																																														
-7.....	81.00	-45.....	Deduct 27.00																																																																																																																														
-8.....	86.00	-51.....	0.00																																																																																																																														
-VP (NB)	35.00	-52.....	Deduct 81.00																																																																																																																														
-16 (ARE).....	174.00	-55**	87.00																																																																																																																														
-16 (NB)	195.00	-C	86.00																																																																																																																														
-17 (ARE).....	224.00	-X	0.00																																																																																																																														
-17 (NB)	288.00																																																																																																																																
LIST PRICE																																																																																																																																	
PIPE SIZE	49700	49700 -LF	49700 -NB	49700 -LF-NB																																																																																																																													
2", 3"	\$837.00	\$750.00	\$987.00	\$900.00																																																																																																																													
-LF	Deduct \$87.00	-30.....	216.00																																																																																																																														
-NB	150.00	-43.....	144.00																																																																																																																														
-LG (ARE)	Deduct 69.00	-45.....	Deduct 27.00																																																																																																																														
-LG (NB)	Deduct 138.00	-51.....	0.00																																																																																																																														
-3.....	0.00	-52.....	Deduct 76.00																																																																																																																														
-4.....	0.00	-55*	87.00																																																																																																																														
-7.....	81.00	-C	86.00																																																																																																																														
-8.....	87.00	-X	0.00																																																																																																																														
-VP (NB)	35.00																																																																																																																																
-16 (ARE).....	174.00																																																																																																																																
-16 (NB)	\$195.00																																																																																																																																
<p>49520A</p> 	<p>SUPER-FLO® 8" ROUND TOP, 6" DEEP</p> <table border="1"> <thead> <tr> <th colspan="5">LIST PRICE</th> </tr> <tr> <th>PIPE SIZE</th> <th>49520A</th> <th>49520A -LF</th> <th>49520A -NB</th> <th>49520A -LF-NB</th> </tr> </thead> <tbody> <tr> <td>2" - 4"</td> <td>\$739.00</td> <td>\$608.00</td> <td>\$948.00</td> <td>\$817.00</td> </tr> </tbody> </table> <p>ADD FOR OPTIONS:</p> <table> <tr> <td>-LF</td> <td>Deduct \$131.00</td> <td>-18 (ARE).....</td> <td>\$243.00</td> </tr> <tr> <td>-NB</td> <td>209.00</td> <td>-18 (NB)</td> <td>404.00</td> </tr> <tr> <td>-LG (ARE)</td> <td>Deduct 87.00</td> <td>-31.....</td> <td>103.00</td> </tr> <tr> <td>-LG (NB)</td> <td>Deduct 95.00</td> <td>-33.....</td> <td>249.00</td> </tr> <tr> <td>-3.....</td> <td>0.00</td> <td>-35*</td> <td>216.00</td> </tr> <tr> <td>-4.....</td> <td>0.00</td> <td>-43.....</td> <td>144.00</td> </tr> <tr> <td>-7.....</td> <td>81.00</td> <td>-45.....</td> <td>Deduct 27.00</td> </tr> <tr> <td>-8.....</td> <td>86.00</td> <td>-51.....</td> <td>0.00</td> </tr> <tr> <td>-VP (NB)</td> <td>35.00</td> <td>-52.....</td> <td>Deduct 76.00</td> </tr> <tr> <td>-16 (ARE).....</td> <td>174.00</td> <td>-55**</td> <td>87.00</td> </tr> <tr> <td>-16 (NB)</td> <td>195.00</td> <td>-C</td> <td>86.00</td> </tr> <tr> <td>-17 (ARE).....</td> <td>224.00</td> <td>-X</td> <td>0.00</td> </tr> <tr> <td>-17 (NB)</td> <td>288.00</td> <td></td> <td></td> </tr> </table> <p>* Specify -31 or -33 Bucket ** 88450 Provided</p>	LIST PRICE					PIPE SIZE	49520A	49520A -LF	49520A -NB	49520A -LF-NB	2" - 4"	\$739.00	\$608.00	\$948.00	\$817.00	-LF	Deduct \$131.00	-18 (ARE).....	\$243.00	-NB	209.00	-18 (NB)	404.00	-LG (ARE)	Deduct 87.00	-31.....	103.00	-LG (NB)	Deduct 95.00	-33.....	249.00	-3.....	0.00	-35*	216.00	-4.....	0.00	-43.....	144.00	-7.....	81.00	-45.....	Deduct 27.00	-8.....	86.00	-51.....	0.00	-VP (NB)	35.00	-52.....	Deduct 76.00	-16 (ARE).....	174.00	-55**	87.00	-16 (NB)	195.00	-C	86.00	-17 (ARE).....	224.00	-X	0.00	-17 (NB)	288.00			<p>OPTION DESCRIPTIONS</p> <ul style="list-style-type: none"> -C Clamp Device -LF Less Flange -LG Less Grate -NB Nickel Bronze Traffic Top -VP Secured Grate, Vandal-Proof Screws -3 1/2 Grate -4 3/4 Grate -5 Nikaloy Extra Heavy-Duty Grate & Rim (Not SUPER-FLO® Design) -7 Full Grate with 2-1/2" Center Opening -8 Stainless Steel Depressed Grate -15 Stainless Steel Rim and Grate -16 Grate with 4" Round Funnel -17 Grate with 6" Round Funnel -18 Grate with 9" x 3-1/2" Oval Funnel -20 Solid Nikaloy Cover -24 Chained Grate -30 Stainless Steel Sediment Bucket -31 Sediment Bucket (Aluminum) -33 Sediment Bucket (A.R. Finish) -35 Stainless Steel Mesh Bucket Liner -43 Internal Dome Strainer (A.R. Finish) -45 Less Internal Dome Strainer -51 Galvanized Cast Iron Inside and Outside -52 Painted Inside and Outside -55 1/2" Primer Tap or Adapter 																																																												
LIST PRICE																																																																																																																																	
PIPE SIZE	49520A	49520A -LF	49520A -NB	49520A -LF-NB																																																																																																																													
2" - 4"	\$739.00	\$608.00	\$948.00	\$817.00																																																																																																																													
-LF	Deduct \$131.00	-18 (ARE).....	\$243.00																																																																																																																														
-NB	209.00	-18 (NB)	404.00																																																																																																																														
-LG (ARE)	Deduct 87.00	-31.....	103.00																																																																																																																														
-LG (NB)	Deduct 95.00	-33.....	249.00																																																																																																																														
-3.....	0.00	-35*	216.00																																																																																																																														
-4.....	0.00	-43.....	144.00																																																																																																																														
-7.....	81.00	-45.....	Deduct 27.00																																																																																																																														
-8.....	86.00	-51.....	0.00																																																																																																																														
-VP (NB)	35.00	-52.....	Deduct 76.00																																																																																																																														
-16 (ARE).....	174.00	-55**	87.00																																																																																																																														
-16 (NB)	195.00	-C	86.00																																																																																																																														
-17 (ARE).....	224.00	-X	0.00																																																																																																																														
-17 (NB)	288.00																																																																																																																																
<p>49580A</p> 	<p>SUPER-FLO® 12" ROUND TOP, 8" DEEP</p> <table border="1"> <thead> <tr> <th colspan="5">LIST PRICE</th> </tr> <tr> <th>PIPE SIZE</th> <th>49580A</th> <th>49580A -LF</th> <th>49580A -NB</th> <th>49580A -LF-NB</th> </tr> </thead> <tbody> <tr> <td>2" - 4"</td> <td>\$945.00</td> <td>\$773.00</td> <td>\$1,405.00</td> <td>\$1,233.00</td> </tr> </tbody> </table> <p>ADD FOR OPTIONS:</p> <table> <tr> <td>-LF</td> <td>Deduct \$172.00</td> <td>-18 (ARE).....</td> <td>\$243.00</td> </tr> <tr> <td>-NB</td> <td>460.00</td> <td>-18 (NB)</td> <td>404.00</td> </tr> <tr> <td>-LG (ARE)</td> <td>Deduct 120.00</td> <td>-31.....</td> <td>144.00</td> </tr> <tr> <td>-LG (NB)</td> <td>Deduct 234.00</td> <td>-33.....</td> <td>216.00</td> </tr> <tr> <td>-3.....</td> <td>0.00</td> <td>-35*</td> <td>216.00</td> </tr> <tr> <td>-4.....</td> <td>0.00</td> <td>-43.....</td> <td>144.00</td> </tr> <tr> <td>-7.....</td> <td>81.00</td> <td>-45.....</td> <td>Deduct 27.00</td> </tr> <tr> <td>-8.....</td> <td>87.00</td> <td>-51.....</td> <td>0.00</td> </tr> <tr> <td>-VP (NB)</td> <td>35.00</td> <td>-52.....</td> <td>Deduct 131.00</td> </tr> <tr> <td>-16 (ARE).....</td> <td>174.00</td> <td>-55**</td> <td>87.00</td> </tr> <tr> <td>-16 (NB)</td> <td>195.00</td> <td>-C</td> <td>86.00</td> </tr> <tr> <td>-17 (ARE).....</td> <td>224.00</td> <td>-X</td> <td>0.00</td> </tr> <tr> <td>-17 (NB)</td> <td>288.00</td> <td>-Z.....</td> <td>0.00</td> </tr> </table> <p>* Specify -31 or -33 Bucket ** 88450 Provided</p>	LIST PRICE					PIPE SIZE	49580A	49580A -LF	49580A -NB	49580A -LF-NB	2" - 4"	\$945.00	\$773.00	\$1,405.00	\$1,233.00	-LF	Deduct \$172.00	-18 (ARE).....	\$243.00	-NB	460.00	-18 (NB)	404.00	-LG (ARE)	Deduct 120.00	-31.....	144.00	-LG (NB)	Deduct 234.00	-33.....	216.00	-3.....	0.00	-35*	216.00	-4.....	0.00	-43.....	144.00	-7.....	81.00	-45.....	Deduct 27.00	-8.....	87.00	-51.....	0.00	-VP (NB)	35.00	-52.....	Deduct 131.00	-16 (ARE).....	174.00	-55**	87.00	-16 (NB)	195.00	-C	86.00	-17 (ARE).....	224.00	-X	0.00	-17 (NB)	288.00	-Z.....	0.00	<p>Outlets</p> <ul style="list-style-type: none"> -X Inside Caulk Outlet -Z No-Hub Outlet 																																																												
LIST PRICE																																																																																																																																	
PIPE SIZE	49580A	49580A -LF	49580A -NB	49580A -LF-NB																																																																																																																													
2" - 4"	\$945.00	\$773.00	\$1,405.00	\$1,233.00																																																																																																																													
-LF	Deduct \$172.00	-18 (ARE).....	\$243.00																																																																																																																														
-NB	460.00	-18 (NB)	404.00																																																																																																																														
-LG (ARE)	Deduct 120.00	-31.....	144.00																																																																																																																														
-LG (NB)	Deduct 234.00	-33.....	216.00																																																																																																																														
-3.....	0.00	-35*	216.00																																																																																																																														
-4.....	0.00	-43.....	144.00																																																																																																																														
-7.....	81.00	-45.....	Deduct 27.00																																																																																																																														
-8.....	87.00	-51.....	0.00																																																																																																																														
-VP (NB)	35.00	-52.....	Deduct 131.00																																																																																																																														
-16 (ARE).....	174.00	-55**	87.00																																																																																																																														
-16 (NB)	195.00	-C	86.00																																																																																																																														
-17 (ARE).....	224.00	-X	0.00																																																																																																																														
-17 (NB)	288.00	-Z.....	0.00																																																																																																																														





	6" X 12" RECTANGULAR TOP, 7" DEEP			
	LIST PRICE			
PIPE SIZE	49720	49720 -LF	49720 -NB	49720 -LF-NB
3", 4", 6"	\$1,114.00	\$987.00	\$1,338.00	\$1,211.00
ADD FOR OPTIONS:				
-LF	Deduct \$127.00	-18 (ARE).....	\$243.00	
-NB	224.00	-18 (NB)	403.00	
-LG (ARE)	Deduct 87.00	-30.....	216.00	
-LG (NB)	Deduct 155.00	-43.....	144.00	
-3.....	0.00	-45.....	Deduct 27.00	
-4.....	0.00	-51.....	0.00	
-7.....	81.00	-52.....	Deduct 131.00	
-8.....	87.00	-55*	87.00	
-VP	35.00	-C	86.00	
-16 (ARE).....	174.00	-X	0.00	
-16 (NB)	195.00			
* 88450 Provided for 3" & 4". Body Primer Tapped for 6".				
	12" ROUND FLUSHING RIM TOP			
	LIST PRICE			
PIPE SIZE	49850			
2"*, 3"* 4", 6"	\$1,200.00			
ADD FOR OPTIONS:				
-VP	\$0.00	-98.....	\$2,576.00	
-13.....	45.00	-C	87.00	
-14.....	132.00	-X	0.00	
-51.....	0.00	-Z (6")	0.00	
*The 49852 and 49853 use a 49854 Body with a Reducing Coupling.				
	12" SQUARE CAN WASH DRAIN			
	LIST PRICE			
PIPE SIZE	49870A			
3", 4"	\$2,335.00			
ADD FOR OPTIONS:				
-VP	\$35.00	-C	86.00	
-35.....	135.00	-X	0.00	
-51.....	0.00	-Z.....	0.00	
-55*	87.00			
-98.....	\$2,576.00			
* 88450 Provided				

Sanitary Floor Sink OPTION DESCRIPTIONS

- C Clamp Device
- LF Less Flange
- LG Less Grate
- NB Nickel Bronze Traffic Top
- VP Secured Grate, Vandal-Proof Screws
- 3 1/2 Grate
- 4 3/4 Grate
- 7 Full Grate with 2-1/2" Center Opening
- 8 Stainless Steel Depressed Grate
- 13 One-Piece Satin Nikaloy Grate
- 14 Loose-Set Satin Nikaloy Grate
- 16 Grate with 4" Round Funnel
- 18 Grate with 9" x 3-1/2" Oval Funnel
- 30 Stainless Steel Sediment Bucket
- 35 Stainless Steel Mesh Bucket Liner
- 43 Internal Dome Strainer (A.R. Finish)
- 45 Less Internal Dome Strainer
- 51 Galvanized Cast Iron Inside and Outside
- 52 Painted Inside and Outside
- 55 1/2" Primer Tap or Adapter
- 98 Water Supply Control Box

Outlets

- X Inside Caulk Outlet
- Z No-Hub Outlet

	LEVELEZE® KLEENATRON® II SPECIAL-DUTY					FLOOR CLEANOUT																																																																															
	LIST PRICE					LIST PRICE																																																																															
<table border="1"> <thead> <tr> <th>PIPE SIZE</th> <th>55000</th> <th>55000-1 55000-2</th> <th>55000-SS 55000-1-SQ</th> </tr> </thead> <tbody> <tr> <td>2"</td> <td>\$190.00</td> <td>\$270.00</td> <td>\$270.00</td> </tr> <tr> <td>3"</td> <td>226.00</td> <td>306.00</td> <td>306.00</td> </tr> <tr> <td>4"</td> <td>276.00</td> <td>356.00</td> <td>356.00</td> </tr> <tr> <td>5" (Z)</td> <td>463.00</td> <td>543.00</td> <td>543.00</td> </tr> <tr> <td>6" (Z)</td> <td>526.00</td> <td>606.00</td> <td>606.00</td> </tr> </tbody> </table>	PIPE SIZE	55000	55000-1 55000-2	55000-SS 55000-1-SQ	2"	\$190.00	\$270.00	\$270.00	3"	226.00	306.00	306.00	4"	276.00	356.00	356.00	5" (Z)	463.00	543.00	543.00	6" (Z)	526.00	606.00	606.00	ADD FOR OPTIONS:				<table border="1"> <thead> <tr> <th>PIPE SIZE</th> <th>2", 3"</th> <th>4"</th> </tr> </thead> <tbody> <tr> <td></td> <td>\$451.00</td> <td>\$468.00</td> </tr> </tbody> </table>			PIPE SIZE	2", 3"	4"		\$451.00	\$468.00																																																
PIPE SIZE	55000	55000-1 55000-2	55000-SS 55000-1-SQ																																																																																		
2"	\$190.00	\$270.00	\$270.00																																																																																		
3"	226.00	306.00	306.00																																																																																		
4"	276.00	356.00	356.00																																																																																		
5" (Z)	463.00	543.00	543.00																																																																																		
6" (Z)	526.00	606.00	606.00																																																																																		
PIPE SIZE	2", 3"	4"																																																																																			
	\$451.00	\$468.00																																																																																			
<table border="0"> <tr> <td>-1</td> <td>\$80.00</td> <td>-14</td> <td>\$36.00</td> </tr> <tr> <td>-1-SD</td> <td>134.00</td> <td>-VP</td> <td>43.00</td> </tr> <tr> <td>-1-12</td> <td>80.00</td> <td>-22 (2"-4")</td> <td>86.00</td> </tr> <tr> <td>-1-13</td> <td>242.00</td> <td>-22 (5", 6")</td> <td>282.00</td> </tr> <tr> <td>-1-SQ</td> <td>80.00</td> <td>-31</td> <td>99.00</td> </tr> <tr> <td>-2</td> <td>80.00</td> <td>-41</td> <td>48.00</td> </tr> <tr> <td>-2-SD</td> <td>134.00</td> <td>-F</td> <td>0.00</td> </tr> <tr> <td>-2-12</td> <td>80.00</td> <td>-WF*</td> <td>217.00</td> </tr> <tr> <td>-2-13</td> <td>242.00</td> <td>-CFC</td> <td>131.00</td> </tr> <tr> <td>-2-SQ</td> <td>80.00</td> <td>-X</td> <td>0.00</td> </tr> <tr> <td>-SS</td> <td>80.00</td> <td>-Y</td> <td>0.00</td> </tr> <tr> <td>-SS-SQ</td> <td>80.00</td> <td>-Z</td> <td>0.00</td> </tr> <tr> <td>-5</td> <td>139.00</td> <td></td> <td></td> </tr> </table> <p>* Not Available on Cast Iron</p>				-1	\$80.00	-14	\$36.00	-1-SD	134.00	-VP	43.00	-1-12	80.00	-22 (2"-4")	86.00	-1-13	242.00	-22 (5", 6")	282.00	-1-SQ	80.00	-31	99.00	-2	80.00	-41	48.00	-2-SD	134.00	-F	0.00	-2-12	80.00	-WF*	217.00	-2-13	242.00	-CFC	131.00	-2-SQ	80.00	-X	0.00	-SS	80.00	-Y	0.00	-SS-SQ	80.00	-Z	0.00	-5	139.00			ADD FOR OPTIONS:			<table border="0"> <tr> <td>-AE</td> <td>\$109.00</td> <td>-12</td> <td>\$164.00</td> </tr> <tr> <td>-1</td> <td>184.00</td> <td>-14</td> <td>36.00</td> </tr> <tr> <td>-2</td> <td>159.00</td> <td>-VP</td> <td>69.00</td> </tr> <tr> <td>-6</td> <td>148.00</td> <td>-20</td> <td>0.00</td> </tr> <tr> <td>-6-1</td> <td>366.00</td> <td>-31</td> <td>205.00</td> </tr> <tr> <td>-6-2</td> <td>315.00</td> <td>-X</td> <td>0.00</td> </tr> </table>			-AE	\$109.00	-12	\$164.00	-1	184.00	-14	36.00	-2	159.00	-VP	69.00	-6	148.00	-20	0.00	-6-1	366.00	-31	205.00	-6-2	315.00	-X	0.00
-1	\$80.00	-14	\$36.00																																																																																		
-1-SD	134.00	-VP	43.00																																																																																		
-1-12	80.00	-22 (2"-4")	86.00																																																																																		
-1-13	242.00	-22 (5", 6")	282.00																																																																																		
-1-SQ	80.00	-31	99.00																																																																																		
-2	80.00	-41	48.00																																																																																		
-2-SD	134.00	-F	0.00																																																																																		
-2-12	80.00	-WF*	217.00																																																																																		
-2-13	242.00	-CFC	131.00																																																																																		
-2-SQ	80.00	-X	0.00																																																																																		
-SS	80.00	-Y	0.00																																																																																		
-SS-SQ	80.00	-Z	0.00																																																																																		
-5	139.00																																																																																				
-AE	\$109.00	-12	\$164.00																																																																																		
-1	184.00	-14	36.00																																																																																		
-2	159.00	-VP	69.00																																																																																		
-6	148.00	-20	0.00																																																																																		
-6-1	366.00	-31	205.00																																																																																		
-6-2	315.00	-X	0.00																																																																																		
	SPANNER TYPE FLOOR CLEANOUT					Cleanout OPTION DESCRIPTIONS																																																																															
	LIST PRICE																																																																																				
<table border="1"> <thead> <tr> <th>PIPE SIZE</th> <th>2"</th> <th>3"</th> <th>4"</th> <th>5"</th> <th>6"</th> </tr> </thead> <tbody> <tr> <td></td> <td>\$226.00</td> <td>\$314.00</td> <td>\$348.00</td> <td>\$547.00</td> <td>\$599.00</td> </tr> </tbody> </table>	PIPE SIZE	2"	3"	4"	5"	6"		\$226.00	\$314.00	\$348.00	\$547.00	\$599.00	ADD FOR OPTIONS:					<table border="0"> <tr> <td>-AE</td> <td>Adjustable Extension</td> </tr> <tr> <td>-CFC</td> <td>Carpet Cleanout Flange Cover</td> </tr> <tr> <td>-F</td> <td>Flange Only</td> </tr> <tr> <td>-LT</td> <td>Less Top</td> </tr> <tr> <td>-SS</td> <td>Stainless Steel Top</td> </tr> <tr> <td>-SS-SQ</td> <td>Square Top, Stainless Steel</td> </tr> <tr> <td>-VP</td> <td>Secured Cover, Vandal-Proof Screws</td> </tr> <tr> <td>-WF</td> <td>Wide Flange (not available on CI)</td> </tr> <tr> <td>-1</td> <td>Satin Finish Nikaloy Top</td> </tr> <tr> <td>-1-SD</td> <td>Special Duty Satin Finish Nikaloy Top</td> </tr> <tr> <td>-1-SQ</td> <td>Square Top, Satin Finish Nikaloy</td> </tr> <tr> <td>-1-12</td> <td>Cover Recessed for Tile, Satin Finish Nikaloy</td> </tr> <tr> <td>-1-13</td> <td>Terrazzo Tile Cover, Satin Finish Nikaloy</td> </tr> <tr> <td>-2</td> <td>Satin Finish Bronze Top</td> </tr> <tr> <td>-2-SD</td> <td>Special Duty Satin Finish Bronze Top</td> </tr> <tr> <td>-2-SQ</td> <td>Square Top, Satin Finish Bronze</td> </tr> <tr> <td>-2-12</td> <td>Cover Recessed for Tile, Satin Finish Bronze</td> </tr> <tr> <td>-2-13</td> <td>Terrazzo Tile Cover, Satin Finish Bronze</td> </tr> <tr> <td>-5</td> <td>Ductile Iron Top</td> </tr> <tr> <td>-6</td> <td>Square Top, Cast Iron</td> </tr> <tr> <td>-6-1</td> <td>Square Top, Nikaloy</td> </tr> <tr> <td>-6-2</td> <td>Square Top, Bronze</td> </tr> <tr> <td>-11</td> <td>Smooth Top</td> </tr> <tr> <td>-12</td> <td>Cover Recessed for Tile</td> </tr> <tr> <td>-14</td> <td>Carpet Cleanout Marker</td> </tr> <tr> <td>-20</td> <td>Raised Head Bronze Plug</td> </tr> <tr> <td>-22</td> <td>Taper Thread Bronze Plug</td> </tr> <tr> <td>-24</td> <td>Spanner Wrench</td> </tr> <tr> <td>-31</td> <td>Galvanized Cast Iron Parts</td> </tr> <tr> <td>-41</td> <td>Clamp Ring and Flange</td> </tr> </table>						-AE	Adjustable Extension	-CFC	Carpet Cleanout Flange Cover	-F	Flange Only	-LT	Less Top	-SS	Stainless Steel Top	-SS-SQ	Square Top, Stainless Steel	-VP	Secured Cover, Vandal-Proof Screws	-WF	Wide Flange (not available on CI)	-1	Satin Finish Nikaloy Top	-1-SD	Special Duty Satin Finish Nikaloy Top	-1-SQ	Square Top, Satin Finish Nikaloy	-1-12	Cover Recessed for Tile, Satin Finish Nikaloy	-1-13	Terrazzo Tile Cover, Satin Finish Nikaloy	-2	Satin Finish Bronze Top	-2-SD	Special Duty Satin Finish Bronze Top	-2-SQ	Square Top, Satin Finish Bronze	-2-12	Cover Recessed for Tile, Satin Finish Bronze	-2-13	Terrazzo Tile Cover, Satin Finish Bronze	-5	Ductile Iron Top	-6	Square Top, Cast Iron	-6-1	Square Top, Nikaloy	-6-2	Square Top, Bronze	-11	Smooth Top	-12	Cover Recessed for Tile	-14	Carpet Cleanout Marker	-20	Raised Head Bronze Plug	-22	Taper Thread Bronze Plug	-24	Spanner Wrench	-31	Galvanized Cast Iron Parts	-41	Clamp Ring and Flange		
PIPE SIZE	2"	3"	4"	5"	6"																																																																																
	\$226.00	\$314.00	\$348.00	\$547.00	\$599.00																																																																																
-AE	Adjustable Extension																																																																																				
-CFC	Carpet Cleanout Flange Cover																																																																																				
-F	Flange Only																																																																																				
-LT	Less Top																																																																																				
-SS	Stainless Steel Top																																																																																				
-SS-SQ	Square Top, Stainless Steel																																																																																				
-VP	Secured Cover, Vandal-Proof Screws																																																																																				
-WF	Wide Flange (not available on CI)																																																																																				
-1	Satin Finish Nikaloy Top																																																																																				
-1-SD	Special Duty Satin Finish Nikaloy Top																																																																																				
-1-SQ	Square Top, Satin Finish Nikaloy																																																																																				
-1-12	Cover Recessed for Tile, Satin Finish Nikaloy																																																																																				
-1-13	Terrazzo Tile Cover, Satin Finish Nikaloy																																																																																				
-2	Satin Finish Bronze Top																																																																																				
-2-SD	Special Duty Satin Finish Bronze Top																																																																																				
-2-SQ	Square Top, Satin Finish Bronze																																																																																				
-2-12	Cover Recessed for Tile, Satin Finish Bronze																																																																																				
-2-13	Terrazzo Tile Cover, Satin Finish Bronze																																																																																				
-5	Ductile Iron Top																																																																																				
-6	Square Top, Cast Iron																																																																																				
-6-1	Square Top, Nikaloy																																																																																				
-6-2	Square Top, Bronze																																																																																				
-11	Smooth Top																																																																																				
-12	Cover Recessed for Tile																																																																																				
-14	Carpet Cleanout Marker																																																																																				
-20	Raised Head Bronze Plug																																																																																				
-22	Taper Thread Bronze Plug																																																																																				
-24	Spanner Wrench																																																																																				
-31	Galvanized Cast Iron Parts																																																																																				
-41	Clamp Ring and Flange																																																																																				
ADD FOR OPTIONS:					<table border="0"> <tr> <td>-2</td> <td>Deduct \$35.00</td> <td>-24</td> <td>\$69.00</td> </tr> <tr> <td>-11</td> <td>0.00</td> <td>-X</td> <td>0.00</td> </tr> <tr> <td>-14</td> <td>36.00</td> <td></td> <td></td> </tr> </table>						-2	Deduct \$35.00	-24	\$69.00	-11	0.00	-X	0.00	-14	36.00																																																																	
-2	Deduct \$35.00	-24	\$69.00																																																																																		
-11	0.00	-X	0.00																																																																																		
-14	36.00																																																																																				
	LEVELEZE® KLEENATRON® SPECIAL-DUTY CAST IRON TOP 57008-Z-CI Standard				Outlets																																																																																
	LIST PRICE																																																																																				
<table border="1"> <thead> <tr> <th>PIPE SIZE</th> <th>8"</th> <th>\$650.00</th> </tr> </thead> </table>	PIPE SIZE	8"	\$650.00	ADD FOR OPTIONS:				<table border="0"> <tr> <td>-X</td> <td>Inside Caulk Outlet</td> </tr> <tr> <td>-Y</td> <td>Hub Outlet w/Gasket 2" -4"</td> </tr> <tr> <td>-Z</td> <td>No-Hub Outlet</td> </tr> </table>						-X	Inside Caulk Outlet	-Y	Hub Outlet w/Gasket 2" -4"	-Z	No-Hub Outlet																																																																		
PIPE SIZE	8"	\$650.00																																																																																			
-X	Inside Caulk Outlet																																																																																				
-Y	Hub Outlet w/Gasket 2" -4"																																																																																				
-Z	No-Hub Outlet																																																																																				
<table border="0"> <tr> <td>-1</td> <td>\$106.00</td> <td>-2-12</td> <td>\$79.00</td> </tr> <tr> <td>-1-SD</td> <td>179.00</td> <td>-14</td> <td>36.00</td> </tr> <tr> <td>-1-SQ</td> <td>106.00</td> <td>-VP</td> <td>43.00</td> </tr> <tr> <td>-1-12</td> <td>108.00</td> <td>-LT</td> <td>Deduct 289.00</td> </tr> <tr> <td>-2</td> <td>79.00</td> <td>-31</td> <td>99.00</td> </tr> <tr> <td>-2-SD</td> <td>152.00</td> <td>-CFC</td> <td>131.00</td> </tr> <tr> <td>-2-SQ</td> <td>79.00</td> <td>-Z</td> <td>STD</td> </tr> </table>				-1	\$106.00	-2-12	\$79.00	-1-SD	179.00	-14	36.00	-1-SQ	106.00	-VP	43.00	-1-12	108.00	-LT	Deduct 289.00	-2	79.00	-31	99.00	-2-SD	152.00	-CFC	131.00	-2-SQ	79.00	-Z	STD																																																						
-1	\$106.00	-2-12	\$79.00																																																																																		
-1-SD	179.00	-14	36.00																																																																																		
-1-SQ	106.00	-VP	43.00																																																																																		
-1-12	108.00	-LT	Deduct 289.00																																																																																		
-2	79.00	-31	99.00																																																																																		
-2-SD	152.00	-CFC	131.00																																																																																		
-2-SQ	79.00	-Z	STD																																																																																		
	ADJUSTABLE FLOOR CLEANOUT					ADD FOR OPTIONS:																																																																															
	LIST PRICE																																																																																				
<table border="1"> <thead> <tr> <th>PIPE SIZE</th> <th>2"</th> <th>3"</th> <th>4"</th> <th>5"</th> <th>6"</th> </tr> </thead> <tbody> <tr> <td></td> <td>\$228.00</td> <td>\$261.00</td> <td>\$299.00</td> <td>\$337.00</td> <td>\$344.00</td> </tr> </tbody> </table>	PIPE SIZE	2"	3"	4"	5"	6"		\$228.00	\$261.00	\$299.00	\$337.00	\$344.00	<table border="0"> <tr> <td>-2</td> <td>Deduct \$17.00</td> <td>-31</td> <td>\$41.00</td> </tr> <tr> <td>-14</td> <td>36.00</td> <td>-Y</td> <td>0.00</td> </tr> <tr> <td>-VP</td> <td>43.00</td> <td>-Z</td> <td>0.00</td> </tr> </table>					-2	Deduct \$17.00	-31	\$41.00	-14	36.00	-Y	0.00	-VP	43.00	-Z	0.00																																																								
PIPE SIZE	2"	3"	4"	5"	6"																																																																																
	\$228.00	\$261.00	\$299.00	\$337.00	\$344.00																																																																																
-2	Deduct \$17.00	-31	\$41.00																																																																																		
-14	36.00	-Y	0.00																																																																																		
-VP	43.00	-Z	0.00																																																																																		

	58540						
	THREADED BRONZE PLUG						
	LIST PRICE						
	PIPE SIZE	1"	1-1/4"	1-1/2"	2"	2-1/2"	3"
	\$19.00	\$19.00	\$19.00	\$25.00	\$31.00	\$43.00	
PIPE SIZE	3-1/2"	4"	5"	6"	8"	*10"	
	\$71.00	\$80.00	\$119.00	\$164.00	\$330.00	\$487.00	
ADD FOR OPTIONS:							
	-19	\$21.00		-20		\$0.00	
* For 10" Size, Specify 58549-20. 10" Size Available with Raised Head Plug Only							

	58620		
	WALL OR FLOOR ACCESS COVER		
	LIST PRICE		
	TYPE NO.	58624	58626
	\$376.00	\$489.00	
ADD FOR OPTIONS:			
-2 (58624)	Deduct \$26.00	-C06	\$193.00
-2 (58626)	Deduct 53.00	-20*	0.00
-10	0.00	-31*	72.00
-14	36.00	-COT2	104.00
-VP	43.00	-COT3	130.00
-C02	43.00	-COT4	204.00
-C03	69.00	-COT6	578.00
-C04	94.00		
* Specify -CO or -COT.			

	58580				
	ACCESS HOUSING AND COVER				
	LIST PRICE				
	PIPE SIZE	58580	58580-1	58580-2	58580-5
	\$139.00	\$191.00	\$174.00	\$278.00	
	194.00	270.00	246.00	333.00	
	256.00	341.00	323.00	395.00	
ADD FOR OPTIONS:					
-1 (2")	\$52.00	-5	\$139.00		
-1 (3", 4")	76.00	-SD	72.00		
-1 (5", 6")	85.00	-SQ (2")	52.00		
-2 (2")	35.00	-SQ (3", 4")	76.00		
-2 (3", 4")	52.00	-SQ (5", 6")	85.00		
-2 (5", 6")	67.00				



	58630		
	WALL OR FLOOR ACCESS COVER		
	LIST PRICE		
	TYPE NO.	58631	58632
	\$365.00	\$538.00	
ADD FOR OPTIONS:			
-2 (58631)	Deduct \$35.00	-20*	\$0.00
-2 (58632)	Deduct 58.00	-31*	72.00
-VP	43.00	-COT2	104.00
-C02	43.00	-COT3	130.00
-C03	69.00	-COT4	204.00
-C04	94.00	-COT6	578.00
-C06	193.00		
* Specify -CO or -COT.			

	58600			
	WALL ACCESS COVER			
	LIST PRICE			
	TYPE NO.	58604	58606	58608
	\$64.00	\$80.00	\$218.00	
ADD FOR OPTIONS:				
-VP	\$32.00	-20*	\$0.00	
-17	8.00	-C02	43.00	
-PLG1-1/2	19.00	-C03	69.00	
-PLG2	25.00	-C04	94.00	
-PLG2-1/2	31.00	-C06	193.00	
-PLG3	43.00	-31**	72.00	
-PLG3-1/2	71.00	-COT2	104.00	
-PLG4	80.00	-COT3	130.00	
-PLG5	119.00	-COT4	204.00	
-PLG6	164.00	-COT6	578.00	
* Specify -PLG, -CO or -COT. ** Specify -CO or -COT.				

	58640			
	WALL ACCESS COVER			
	LIST PRICE			
	TYPE NO.	58642	58644	58646
	\$277.00	\$407.00	\$439.00	
ADD FOR OPTIONS:				
-2 (58642)	Deduct \$37.00	-C06	\$193.00	
-2 (58644)	Deduct 53.00	-20*	0.00	
-2 (58646)	Deduct 58.00	-31*	72.00	
-10	0.00	-COT2	104.00	
-VP	43.00	-COT3	130.00	
-C02	43.00	-COT4	204.00	
-C03	69.00	-COT6	578.00	
-C04	94.00			
* Specify -CO or -COT.				

	58610			
	WALL OR FLOOR ACCESS COVER			
	LIST PRICE			
	TYPE NO.	58614	58616	58618
	\$164.00	\$281.00	\$405.00	
ADD FOR OPTIONS:				
-2 (58614)	Deduct \$16.00	-C04	\$94.00	
-2 (58616)	Deduct 50.00	-C06	193.00	
-2 (58618)	Deduct 50.00	-20*	0.00	
-10	0.00	-31*	72.00	
-14	36.00	-COT2	104.00	
-VP	43.00	-COT3	130.00	
-C02	43.00	-COT4	204.00	
-C03	69.00	-COT6	578.00	
* Specify -CO or -COT.				

	58650		
	STAINLESS STEEL WALL ACCESS COVER		
	LIST PRICE		
	TYPE NO.	58656	\$407.00
ADD FOR OPTIONS:			
-VP	\$43.00	-31*	\$72.00
-C02	43.00	-COT2	104.00
-C03	69.00	-COT3	130.00
-C04	94.00	-COT4	204.00
-C06	193.00	-COT6	578.00
-20*	0.00		
* Specify -CO or -COT.			

58680 	ACCESS COVER				
	LIST PRICE				
	TYPE NO.	58680		\$640.00	
	ADD FOR OPTIONS:				
	-5	\$212.00	-CO3.....	\$69.00	
	-VP	43.00	-CO4.....	94.00	
	-26	77.00	-CO6.....	193.00	
	-31	256.00	-20*	0.00	
	-CO2.....	43.00			
	Special Wording on Cover, SAN. or STORM, Specify on Order.				
	* Specify -CO				
58900 	NO-HUB CLEANOUT FERRULE				
	LIST PRICE				
	PIPE SIZE	2"	3"	4"	6"
		\$43.00	\$69.00	\$94.00	\$193.00
	ADD FOR OPTIONS:				
	-19	\$21.00	-31	\$72.00	
	-20	0.00	-Z	0.00	
58910 	NO-HUB CLEANOUT TEE WITH PLUG				
	LIST PRICE				
	PIPE SIZE	2"	3"	4"	6"
		\$104.00	\$130.00	\$204.00	\$578.00
	ADD FOR OPTIONS:				
	-19	\$21.00	-31	\$72.00	
	-20	0.00	-Z	0.00	

OPTION DESCRIPTIONS





- CO2 No-Hub Cleanout, 2"
- CO3 No-Hub Cleanout, 3"
- CO4 No-Hub Cleanout, 4"
- CO6 No-Hub Cleanout, 6"
- COT2 No-Hub Cleanout Tee, 2"
- COT3 No-Hub Cleanout Tee, 3"
- COT4 No-Hub Cleanout Tee, 4"
- COT6 No-Hub Cleanout Tee, 6"
- PLG1-1/2 Bronze NPT Plug, 1-1/2"
- PLG2 Bronze NPT Plug, 2"
- PLG2-1/2 Bronze NPT Plug, 2-1/2"
- PLG3 Bronze NPT Plug, 3"
- PLG3-1/2 Bronze NPT Plug, 3-1/2"
- PLG4 Bronze NPT Plug, 4"
- PLG5 Bronze NPT Plug, 5"
- PLG6 Bronze NPT Plug, 6"
- SD Special-Duty Top, Nikaloy
- SQ Square Top
- VP Secured Cover, Vandal-Proof Screws
- 1 Satin Finish Nikaloy Top
- 2 Satin Finish Bronze Top
- 5 Ductile Iron Top
- 10 Scoriated Cover
- 14 Carpet Cleanout Marker
- 17 Center Screw Longer than Standard
- 19 Plug Tapped for Center Screw
- 20 Raised Head Bronze Plug
- 26 Gasketed Cover
- 31 Galvanized Cast Iron Parts

Outlet

- Z No-Hub Outlet

GREASE INTERCEPTORS











	MANUAL CLEANING, ON-FLOOR TYPE												
	TYPE NO.	PIPE SIZE	FLOW RATE GPM	GR. CAP. LBS.	LIST PRICE	FOR OPTIONS, ADD TO LIST PRICE							
						-40	-61	-ISI	-EXT 6"	Ea. Add'l Inch Ext.	-RT	-ET	-HD
	60102H	2	7	14	\$1,491.00	N/A	N/A	\$844.00	N/A	N/A	\$3,139.00	\$3,620.00	\$2,630.00
	60103H	2	10	20	1,752.00	\$2,424.00	\$813.00	844.00	\$2,173.00	\$108.00	3,265.00	3,792.00	2,828.00
	60104H	2	15	30	2,594.00	2,941.00	813.00	844.00	2,203.00	121.00	3,502.00	4,131.00	3,041.00
	60105H	3	20	40	3,175.00	3,289.00	813.00	844.00	2,203.00	138.00	3,727.00	4,453.00	3,221.00
	60106H	3	25	50	3,567.00	3,802.00	908.00	866.00	2,203.00	155.00	3,806.00	4,604.00	3,399.00
	60107H	3	35	70	4,409.00	4,666.00	943.00	980.00	2,669.00	171.00	3,806.00	5,018.00	3,756.00
	60108H	3	50	100	5,839.00	6,487.00	1,071.00	1,465.00	2,887.00	200.00	4,218.00	5,285.00	3,936.00
60109H	3	75	150	12,000.00	POA	1,700.00	1,580.00	3,000.00	220.00	N/A	N/A	4,200.00	
60110H	4	100	200	13,500.00	POA	1,900.00	1,730.00	3,400.00	250.00	N/A	N/A	5,600.00	
ADD FOR OPTIONS													
-40 ABOVE -RT ABOVE -SAP POA• -61 ABOVE -ET ABOVE -GRD* POA• -ISI* ABOVE -HD ABOVE -GRDP POA• -EXT ABOVE -SS POA•													
* -GRD Available Only on 60104H through 60110H. -GRD and -ISI Cannot be Furnished Together.													
• PRICE ON APPLICATION													
	SEMI-AUTOMATIC												
	TYPE NO.	PIPE SIZE	FLOW RATE GPM	GREASE CAP. LBS.	LIST PRICE	FOR OPTIONS, ADD TO LIST PRICE							
						-RT	-ET						
	60102-SA	2	7	14	\$4,247.00	\$3,407.00	\$4,173.00						
	60103-SA	2	10	20	5,010.00	3,957.00	4,741.00						
	60104-SA	2	15	30	5,338.00	4,396.00	5,273.00						
	60105-SA	2	20	40	6,561.00	4,468.00	5,457.00						
	60106-SA	3*	25	50	7,958.00	4,552.00	5,671.00						
	60107-SA	3*	35	70	8,167.00	4,865.00	6,083.00						
	60108-SA	3*	50	100	9,322.00	4,910.00	6,290.00						
ADD FOR OPTIONS													
-62 \$0.00 -66 147.00 -RT ABOVE -65 105.00 -67 207.00 -ET ABOVE													
* 3" Sizes Normally Furnished with 4" x 3" Reducing Bushings.													
	MANUAL CLEANING, LOW TYPE					SEMI-AUTOMATIC, LOW TYPE							
	TYPE NO.	PIPE SIZE	FLOW RATE GPM	GREASE CAP. LBS.		LIST PRICE	TYPE NO.	PIPE SIZE	FLOW RATE GPM	GREASE CAP. LBS.	LIST PRICE		
	60115A	2*	20	40		\$4,759.00	60115A-SA	3	35	70	\$11,159.00		
	60117A	3	35	70		6,128.00							
	ADD FOR OPTIONS:												
-65 \$105.00 -68 \$0.00 -66 147.00													
*2" Sizes Normally Furnished with 3" x 2" Reducing Bushings													









	MANUAL CLEANING TYPE, HIGH VOLUME											
	TYPE NO.	PIPE SIZE	FLOW RATE GPM	GREASE CAP. LBS.	LIST PRICE	FOR OPTIONS, ADD TO LIST PRICE						
						-EXT 6"	Ea. Add'l Inch Ext.	-60	-61	-ISI	-HD	
	60213A	4	150	300	\$16,339.00	\$1,941.00	\$150.00	\$1,490.00	\$2,400.00	\$1,846.00	\$7,342.00	
	60214A	5	200	400	23,703.00	3,493.00	157.00	1,597.00	2,804.00	1,940.00	8,373.00	
	60215A	5	250	500	27,592.00	4,340.00	170.00	2,130.00	3,782.00	2,047.00	11,560.00	
	60216A	6	350	700	36,128.00	6,028.00	217.00	2,694.00	4,525.00	2,585.00	17,497.00	
	60217A	6	500	1000	47,107.00	9,059.00	258.00	3,199.00	5,379.00	3,063.00	24,620.00	
	ADD FOR OPTIONS											
	-EXT ABOVE -61 ABOVE -HD ABOVE -60 ABOVE -ISI ABOVE -SAP POA• • PRICE ON APPLICATION											
	GI 2000A AUTOMATIC GREASE REMOVAL DEVICE					OPTION DESCRIPTIONS -ET Enclosed Type -EXT Extension, 6" Standard, Specify Extension Height -GRD Grease Removal Device -GRDP Grease Removal Device with Probe -HD Heavy-Duty Cover -ISI Integrated Solids Interceptor -RT Recessed Type -SAP Sensing and Alarm Probe -SS Stainless Steel -23 Remote Monitoring Package (-23A) Monitoring Plan (-23B) Monitoring Plan (-23C) Monitoring Plan -40 Cover Recess for Floor Finish -61 Flange and Clamp Device -62 4" Inlet and Outlet Available on Standard 3" Sizes -65 Hub Inlet, Spigot Outlet, 2" -66 Hub Inlet, Spigot Outlet, 3" -67 Hub Inlet, Spigot Outlet, 4" -68 3" Inlet and Outlet Available on Standard 2" Size						
	TYPE NO.	PIPE SIZE	FLOW RATE GPM	GREASE CAP. LBS.	LIST PRICE							
	60306A	3	25	50	POA•							
	60307A	3	35	70	POA•							
	60308A	3	50	100	POA•							
	60309A	4	75	150	POA•							
	60310A	4	100	200	POA•							
	60311A	4	150	300	POA•							
	60312A	6	200	400	POA•							
	60313A	6	250	500	POA•							
60314A	6	350	700	POA•								
60315A	6	500	1000	POA•								
ADD FOR OPTIONS:												
-23 JSP◇ -24 POA• -23A JSP◇ -33 POA• -23B JSP◇ -34 POA• -23C JSP◇ • PRICE ON APPLICATION ◇ Josam Service Program												
	ELECTRONIC GREASE/OIL LEVEL DETECTOR											
	LIST PRICE											
	TYPE NO.	EGOLD-1000	POA•									
	ADD FOR OPTIONS:											
-23 JSP◇ -23B JSP◇ -23A JSP◇ -23C JSP◇ • PRICE ON APPLICATION ◇ Josam Service Program												
	PIT ELECTRONIC GREASE/OIL LEVEL DETECTOR											
	LIST PRICE											
	TYPE NO.	CEGOLD-2000	POA•									
	ADD FOR OPTIONS:											
-23 JSP◇ -23B JSP◇ -23A JSP◇ -23C JSP◇ • PRICE ON APPLICATION ◇ Josam Service Program												









60500B	DRAW-OFF, GRAVITY TYPE								
	TYPE NO.	PIPE SIZE	FLOW RATE GPM	LIST PRICE	FOR OPTIONS, ADD TO LIST PRICE				
					-EXT 6"	Ea. Add'l Inch Ext.	-60	-61	-HD
	60503B	2	10	\$2,657.00	\$2,487.00	\$109.00	\$678.00	\$815.00	\$2,828.00
	60504B	2	15	3,649.00	2,520.00	122.00	678.00	815.00	3,041.00
	60505B	3*	20	4,413.00	2,594.00	136.00	732.00	815.00	3,221.00
	60506B	3*	25	4,789.00	2,669.00	157.00	762.00	908.00	3,399.00
	60507B	3*	35	5,822.00	2,769.00	170.00	800.00	944.00	3,756.00
	60508B	3*	50	7,833.00	3,306.00	197.00	816.00	1,075.00	3,936.00
* 3" Sizes Normally Furnished with 4" x 3" Reducing Bushings.									
ADD FOR OPTIONS									
-EXT ABOVE -61 ABOVE -HD ABOVE -60 ABOVE									



60500-EST	DRAW-OFF, GRAVITY TYPE WITH EXTERNAL STORAGE TANK									
	TYPE NO.	PIPE SIZE	FLOW RATE GPM	TANK CAP. GAL.	LIST PRICE	FOR OPTIONS, ADD TO LIST PRICE				
						-EXT 6"	Ea. Add'l Inch Ext.	-60	-61	-HD
	60503-EST-5	2	10	5	\$3,989.00	\$3,730.00	\$154.00	\$1,010.00	\$1,220.00	\$4,500.00
	60503-EST-50	2	10	50	5,637.00	4,290.00	178.00	1,160.00	1,401.00	5,175.00
	60504-EST-6	2	15	6	5,470.00	3,780.00	185.00	1,010.00	1,220.00	4,790.00
	60504-EST-50	2	15	50	5,949.00	4,350.00	212.00	1,160.00	1,401.00	5,510.00
	60505-EST-8	3*	20	8	6,620.00	3,895.00	210.00	1,010.00	1,220.00	5,070.00
	60505-EST-50	3*	20	50	7,327.00	4,480.00	242.00	1,160.00	1,401.00	5,830.00
	60506-EST-50	3*	25	50	7,180.00	3,930.00	230.00	1,145.00	1,335.00	5,255.00
	60506-EST-100	3*	25	100	7,990.00	4,125.00	235.00	1,145.00	1,335.00	5,780.00
	60507-EST-50	3*	35	50	8,730.00	4,070.00	250.00	1,170.00	1,380.00	5,530.00
	60507-EST-100	3*	35	100	9,540.00	4,275.00	255.00	1,170.00	1,380.00	6,080.00
	60508-EST-100	3*	50	100	11,540.00	4,850.00	290.00	1,190.00	1,580.00	5,810.00
* 3" Sizes Normally Furnished with 4" x 3" Reducing Bushings.										
ADD FOR OPTIONS										
-EXT ABOVE -60 ABOVE -HD ABOVE -19 \$1,100.00 -61 ABOVE										





60610A	DRAW-OFF TYPE, HIGH VOLUME								
	TYPE NO.	PIPE SIZE	FLOW RATE GPM	LIST PRICE	FOR OPTIONS, ADD TO LIST PRICE				
					-EXT 6"	Ea. Add'l Inch Ext.	-60	-61	-HD
	60611A	3	75	13,570.00	1,863.00	122.00	808.00	1,612.00	\$4,156.00
	60612A	4	100	14,716.00	1,941.00	130.00	995.00	1,804.00	5,715.00
	60613A	4	150	18,221.00	2,098.00	150.00	1,388.00	2,236.00	7,342.00
	60614A	5	200	25,743.00	2,999.00	157.00	1,488.00	2,612.00	8,373.00
	60615A	5	250	29,813.00	3,900.00	170.00	1,989.00	3,387.00	11,560.00
	60616A	6	350	37,679.00	5,616.00	217.00	2,507.00	4,210.00	17,497.00
	60617A	6	500	54,740.00	8,746.00	258.00	2,976.00	5,010.00	24,620.00
ADD FOR OPTIONS									
-EXT ABOVE -61 ABOVE -HD ABOVE -60 ABOVE									

60610-EST	DRAW-OFF, GRAVITY TYPE WITH EXTERNAL STORAGE TANK									
	TYPE NO.	PIPE SIZE	FLOW RATE GPM	TANK CAP. GAL	LIST PRICE	FOR OPTIONS, ADD TO LIST PRICE				
						-EXT 10"	Ea. Add'l Inch Ext.	-60	-61	-HD
	60611-EST	3	75	100	\$19,990.00	\$2,740.00	\$185.00	\$1,315.00	\$2,380.00	\$6,110.00
NEW EXTERNAL STORAGE TANK NOT SHOWN	60612-EST	4	100	250	22,080.00	2,910.00	197.00	1,505.00	2,700.00	8,580.00
	60613-EST	4	150	250	27,330.00	3,140.00	225.00	2,080.00	3,350.00	11,010.00
	60614-EST	5	200	250	36,190.00	4,225.00	225.00	2,225.00	3,915.00	11,790.00
	60615-EST	5	250	500	41,920.00	5,480.00	245.00	2,790.00	4,750.00	16,200.00
	60616-EST	6	350	500	52,990.00	7,900.00	305.00	3,520.00	5,910.00	23,420.00
	60617-EST	6	500	500	73,100.00	11,750.00	360.00	4,190.00	7,040.00	34,600.00
	ADD FOR OPTIONS									
-EXT ABOVE -60 ABOVE -HD ABOVE -19 \$1,100.00 -61 ABOVE										
	OIL SEDIMENT INTERCEPTOR					TOP ACCESS ON-FLOOR TRAP TYPE				
	TYPE NO.	PIPE SIZE	LIST PRICE			TYPE NO.	PIPE SIZE	LIST PRICE		
	60816	2	\$1,748.00			61042A	2	\$2,360.00		
60817	4	4,716.00		61043A	3	2,360.00				
60818	4	6,705.00		61044A	4	2,360.00				
60819	4	9,936.00		ADD FOR OPTIONS:						
-16 \$379.00 -EXT* \$401.00 * 6" Standard, Each Add'l. Inch \$44.00										
	BOTTOM ACCESS FIXTURE TRAP TYPE					TOP ACCESS IN-LINE TYPE				
	TYPE NO.	INLET	OUTLET	LIST PRICE		TYPE NO.	PIPE SIZE	LIST PRICE		
	61001-1/4	1-1/4	1-1/2	\$821.00		61072	2	\$1,472.00		
61001-1/2	1-1/2	1-1/2	821.00	61073	3	2,436.00				
ADD FOR OPTIONS:										
-1 Deduct \$372.00 -30 Deduct \$136.00 -3 0.00										
-4 \$582.00 -86 \$0.00 -15 722.00										
	CAST IRON TOP ACCESS FIXTURE TRAP TYPE					TOP ACCESS IN-LINE TYPE				
	TYPE NO.	PIPE SIZE	LIST PRICE			TYPE NO.	PIPE SIZE	LIST PRICE		
	61031-1/2	1-1/2	\$610.00			61084	4	\$5,762.00		
61032	2	610.00		61085	5	5,762.00				
ADD FOR OPTIONS:										
-26 \$338.00 -30 \$174.00										
-4 \$1,288.00 -86 \$0.00 -15 943.00										
	LINT INTERCEPTOR									
	TYPE NO.	PIPE SIZE	FLOW RATE GPM	MAX. NUMBER OF WASHERS	LIST PRICE	FOR OPTIONS, ADD TO LIST PRICE				
						-EXT 6"	Ea. Add'l Inch Ext.			
	61805	3	70	7	\$6,107.00	\$2,203.00	\$138.00			
	61806	4	200	20	8,696.00	2,203.00	155.00			
	61807	6	300	30	10,110.00	2,669.00	171.00			
61808	6	400	40	11,528.00	2,887.00	200.00				
OPTION DESCRIPTIONS										
-EXT	Extension, 6" Standard, Specify Extension Height				-19	Reclaim Tank Alarm				
-HD	Heavy-Duty Cover				-26	Cast Aluminum				
-1	Painted Cast Iron				-30	Acid-Resisting Cast Iron Inside and Outside				
-3	Polished Bronze				-60	Anchor Flange				
-4	Galvanized Cast Iron Parts				-61	Flange and Clamp Device				
-15	Stainless Steel Basket				-86	Flat Bottom Basket				
-16	Monel Screens									

<p>67100A</p> 	<p>BALL-FLOAT ADAPTER TYPE</p> <table border="1"> <thead> <tr> <th colspan="3">LIST PRICE</th> </tr> <tr> <th>PIPE SIZE</th> <th>2", 3", 4"</th> <th>6"</th> </tr> </thead> <tbody> <tr> <td></td> <td>\$267.00</td> <td>\$552.00</td> </tr> </tbody> </table> <p>ADD FOR OPTIONS:</p> <table> <tr> <td>-5 (2" - 4").....</td> <td>\$43.00</td> <td>-35</td> <td>\$71.00</td> </tr> <tr> <td>-5 (6").....</td> <td>109.00</td> <td></td> <td></td> </tr> </table>	LIST PRICE			PIPE SIZE	2", 3", 4"	6"		\$267.00	\$552.00	-5 (2" - 4").....	\$43.00	-35	\$71.00	-5 (6").....	109.00			<p>67650</p> 	<p>COMBINED DRAIN/SWING-CHECK TYPE</p> <table border="1"> <thead> <tr> <th colspan="3">LIST PRICE</th> </tr> <tr> <th>PIPE SIZE</th> <th>3", 4"</th> <th>6"</th> </tr> </thead> <tbody> <tr> <td></td> <td>\$842.00</td> <td>\$1,268.00</td> </tr> </tbody> </table> <p>ADD FOR OPTIONS:</p> <table> <tr> <td>-1 (3", 4")</td> <td>\$399.00</td> <td>-25</td> <td>\$121.00</td> </tr> <tr> <td>-1 (6")</td> <td>347.00</td> <td>-VP</td> <td>66.00</td> </tr> <tr> <td>-2 (3", 4")</td> <td>267.00</td> <td>-LBV (3", 4")... Deduct</td> <td>178.00</td> </tr> <tr> <td>-2 (6")</td> <td>221.00</td> <td>-LBV (6")</td> <td>Deduct 312.00</td> </tr> <tr> <td>-5</td> <td>267.00</td> <td></td> <td></td> </tr> </table>	LIST PRICE			PIPE SIZE	3", 4"	6"		\$842.00	\$1,268.00	-1 (3", 4")	\$399.00	-25	\$121.00	-1 (6")	347.00	-VP	66.00	-2 (3", 4")	267.00	-LBV (3", 4")... Deduct	178.00	-2 (6")	221.00	-LBV (6")	Deduct 312.00	-5	267.00		
LIST PRICE																																																	
PIPE SIZE	2", 3", 4"	6"																																															
	\$267.00	\$552.00																																															
-5 (2" - 4").....	\$43.00	-35	\$71.00																																														
-5 (6").....	109.00																																																
LIST PRICE																																																	
PIPE SIZE	3", 4"	6"																																															
	\$842.00	\$1,268.00																																															
-1 (3", 4")	\$399.00	-25	\$121.00																																														
-1 (6")	347.00	-VP	66.00																																														
-2 (3", 4")	267.00	-LBV (3", 4")... Deduct	178.00																																														
-2 (6")	221.00	-LBV (6")	Deduct 312.00																																														
-5	267.00																																																
<p>67360</p> 	<p>SHEAR-GATE & SWING-CHECK TYPE</p> <table border="1"> <thead> <tr> <th colspan="3">LIST PRICE</th> </tr> <tr> <th>PIPE SIZE</th> <th>67360</th> <th>67360-DH</th> </tr> </thead> <tbody> <tr> <td>3", 4"</td> <td>\$2,313.00</td> <td>\$2,313.00</td> </tr> <tr> <td>5", 6"</td> <td>3,406.00</td> <td>3,406.00</td> </tr> </tbody> </table> <p>ADD FOR OPTIONS:</p> <table> <tr> <td>-DH.....</td> <td>\$0.00</td> <td>-28 (5", 6")</td> <td>\$1,093.00</td> </tr> <tr> <td>-15</td> <td>0.00</td> <td>-29 (3", 4")</td> <td>1,334.00</td> </tr> <tr> <td>-28 (3", 4")</td> <td>953.00</td> <td>-29 (5", 6")</td> <td>1,460.00</td> </tr> </table>	LIST PRICE			PIPE SIZE	67360	67360-DH	3", 4"	\$2,313.00	\$2,313.00	5", 6"	3,406.00	3,406.00	-DH.....	\$0.00	-28 (5", 6")	\$1,093.00	-15	0.00	-29 (3", 4")	1,334.00	-28 (3", 4")	953.00	-29 (5", 6")	1,460.00	<p>67720</p> 	<p>HUB INLET, SWING-CHECK TYPE</p> <table border="1"> <thead> <tr> <th colspan="3">LIST PRICE</th> </tr> <tr> <th>PIPE SIZE</th> <th>3"</th> <th>4"</th> </tr> </thead> <tbody> <tr> <td></td> <td>\$250.00</td> <td>\$363.00</td> </tr> </tbody> </table> <p>ADD FOR OPTIONS:</p> <table> <tr> <td>-15</td> <td>\$0.00</td> <td></td> <td></td> </tr> </table>	LIST PRICE			PIPE SIZE	3"	4"		\$250.00	\$363.00	-15	\$0.00											
LIST PRICE																																																	
PIPE SIZE	67360	67360-DH																																															
3", 4"	\$2,313.00	\$2,313.00																																															
5", 6"	3,406.00	3,406.00																																															
-DH.....	\$0.00	-28 (5", 6")	\$1,093.00																																														
-15	0.00	-29 (3", 4")	1,334.00																																														
-28 (3", 4")	953.00	-29 (5", 6")	1,460.00																																														
LIST PRICE																																																	
PIPE SIZE	3"	4"																																															
	\$250.00	\$363.00																																															
-15	\$0.00																																																
<p>67400</p> 	<p>NO-HUB SWING-CHECK TYPE</p> <table border="1"> <thead> <tr> <th colspan="5">LIST PRICE</th> </tr> <tr> <th>PIPE SIZE</th> <th>2"</th> <th>3"</th> <th>4"</th> <th>6"</th> </tr> </thead> <tbody> <tr> <td></td> <td>\$599.00</td> <td>\$937.00</td> <td>\$1,154.00</td> <td>\$1,476.00</td> </tr> </tbody> </table>	LIST PRICE					PIPE SIZE	2"	3"	4"	6"		\$599.00	\$937.00	\$1,154.00	\$1,476.00	<p>67800</p> 	<p>HUB INLET, SWING-CHECK TYPE</p> <table border="1"> <thead> <tr> <th colspan="3">LIST PRICE</th> </tr> <tr> <th>PIPE SIZE</th> <th>6"</th> <th>8"</th> </tr> </thead> <tbody> <tr> <td></td> <td>\$1,037.00</td> <td>\$1,262.00</td> </tr> </tbody> </table> <p>ADD FOR OPTIONS:</p> <table> <tr> <td>-4</td> <td>\$366.00</td> <td>-15</td> <td>\$0.00</td> </tr> </table>	LIST PRICE			PIPE SIZE	6"	8"		\$1,037.00	\$1,262.00	-4	\$366.00	-15	\$0.00																		
LIST PRICE																																																	
PIPE SIZE	2"	3"	4"	6"																																													
	\$599.00	\$937.00	\$1,154.00	\$1,476.00																																													
LIST PRICE																																																	
PIPE SIZE	6"	8"																																															
	\$1,037.00	\$1,262.00																																															
-4	\$366.00	-15	\$0.00																																														
<p>67500</p> 	<p>HUB & SPIGOT SWING-CHECK TYPE</p> <table border="1"> <thead> <tr> <th colspan="4">LIST PRICE</th> </tr> <tr> <th>PIPE SIZE</th> <th>2"</th> <th>3"</th> <th>4"</th> </tr> </thead> <tbody> <tr> <td></td> <td>\$599.00</td> <td>\$937.00</td> <td>\$1,154.00</td> </tr> <tr> <th>PIPE SIZE</th> <th>6"</th> <th>8"</th> <th></th> </tr> <tr> <td></td> <td>\$1,658.00</td> <td>\$2,330.00</td> <td></td> </tr> </tbody> </table> <p>ADD FOR OPTIONS:</p> <table> <tr> <td>-10*</td> <td>\$0.00</td> <td>-30</td> <td>\$187.00</td> </tr> <tr> <td>-15</td> <td>0.00</td> <td></td> <td></td> </tr> </table> <p>* For Extension, Use -10 Option with Hub and Spigot Extension Pipe by Others.</p>	LIST PRICE				PIPE SIZE	2"	3"	4"		\$599.00	\$937.00	\$1,154.00	PIPE SIZE	6"	8"			\$1,658.00	\$2,330.00		-10*	\$0.00	-30	\$187.00	-15	0.00			<p>Backwater Valve OPTION DESCRIPTIONS</p> <ul style="list-style-type: none"> -DH Double Hub -LBV Less Backwater Valve -VP Secured Face, Vandal-Proof Screws -1 Satin Finish Nikaloy Face -2 Satin Finish Bronze Face -4 Bronze Seat -5 Galvanized Cast Iron Parts -10 Threaded Bronze Cover -15 Open Flap -25 Flashing Clamp Device -28 12" Cast Iron Extension and Stem -29 24" Cast Iron Extension and Stem -30 2" Auxiliary Inlet with Bronze Plug -35 1/2" Primer Tap 																			
LIST PRICE																																																	
PIPE SIZE	2"	3"	4"																																														
	\$599.00	\$937.00	\$1,154.00																																														
PIPE SIZE	6"	8"																																															
	\$1,658.00	\$2,330.00																																															
-10*	\$0.00	-30	\$187.00																																														
-15	0.00																																																
<p>67600</p> 	<p>HUB & SPIGOT SWING-CHECK TYPE</p> <table border="1"> <thead> <tr> <th colspan="3">LIST PRICE</th> </tr> <tr> <th>TYPE NO.</th> <th>PIPE SIZE</th> <th></th> </tr> </thead> <tbody> <tr> <td>67610</td> <td>10"</td> <td>\$3,806.00</td> </tr> <tr> <td>67612</td> <td>12"</td> <td>4,938.00</td> </tr> </tbody> </table> <p>ADD FOR OPTIONS:</p> <table> <tr> <td>-15</td> <td>\$0.00</td> <td></td> <td></td> </tr> </table>	LIST PRICE			TYPE NO.	PIPE SIZE		67610	10"	\$3,806.00	67612	12"	4,938.00	-15	\$0.00																																		
LIST PRICE																																																	
TYPE NO.	PIPE SIZE																																																
67610	10"	\$3,806.00																																															
67612	12"	4,938.00																																															
-15	\$0.00																																																

<p>71000</p> 	<p>HYDRASAN® I WITH VACUUM BREAKER NON-FREEZE</p> <table border="1"> <thead> <tr> <th colspan="2">LIST PRICE</th> </tr> <tr> <th>SIZE</th> <th></th> </tr> </thead> <tbody> <tr> <td>4" Wall</td> <td>\$732.00</td> </tr> <tr> <td>6", 8" Wall</td> <td>732.00</td> </tr> <tr> <td>10", 12", 14" Wall</td> <td>757.00</td> </tr> <tr> <td>16", 18" Wall</td> <td>797.00</td> </tr> <tr> <td>20", 22", 24" Wall</td> <td>838.00</td> </tr> </tbody> </table> <p>ADD FOR OPTIONS:</p> <table border="1"> <tbody> <tr> <td>-52</td> <td>\$28.00</td> <td>-74</td> <td>\$21.00</td> </tr> <tr> <td>-54</td> <td>129.00</td> <td>-91</td> <td>100.00</td> </tr> <tr> <td>-72</td> <td>0.00</td> <td>-95</td> <td>87.00</td> </tr> <tr> <td>-73</td> <td>0.00</td> <td></td> <td></td> </tr> </tbody> </table>	LIST PRICE		SIZE		4" Wall	\$732.00	6", 8" Wall	732.00	10", 12", 14" Wall	757.00	16", 18" Wall	797.00	20", 22", 24" Wall	838.00	-52	\$28.00	-74	\$21.00	-54	129.00	-91	100.00	-72	0.00	-95	87.00	-73	0.00			<p>71450</p> 	<p>YARD HYDRANT, HEAVY-DUTY NON-FREEZE</p> <table border="1"> <thead> <tr> <th colspan="3">LIST PRICE</th> </tr> <tr> <th>SIZE</th> <th>71450 3/4" Connection</th> <th>71450 1" Connection</th> </tr> </thead> <tbody> <tr> <td>2' Bury</td> <td>\$669.00</td> <td>\$1,142.00</td> </tr> <tr> <td>3' Bury</td> <td>767.00</td> <td>1,182.00</td> </tr> <tr> <td>4' Bury</td> <td>803.00</td> <td>1,230.00</td> </tr> <tr> <td>5' Bury</td> <td>840.00</td> <td>1,277.00</td> </tr> <tr> <td>6' Bury</td> <td>868.00</td> <td>1,310.00</td> </tr> </tbody> </table>	LIST PRICE			SIZE	71450 3/4" Connection	71450 1" Connection	2' Bury	\$669.00	\$1,142.00	3' Bury	767.00	1,182.00	4' Bury	803.00	1,230.00	5' Bury	840.00	1,277.00	6' Bury	868.00	1,310.00					
LIST PRICE																																																											
SIZE																																																											
4" Wall	\$732.00																																																										
6", 8" Wall	732.00																																																										
10", 12", 14" Wall	757.00																																																										
16", 18" Wall	797.00																																																										
20", 22", 24" Wall	838.00																																																										
-52	\$28.00	-74	\$21.00																																																								
-54	129.00	-91	100.00																																																								
-72	0.00	-95	87.00																																																								
-73	0.00																																																										
LIST PRICE																																																											
SIZE	71450 3/4" Connection	71450 1" Connection																																																									
2' Bury	\$669.00	\$1,142.00																																																									
3' Bury	767.00	1,182.00																																																									
4' Bury	803.00	1,230.00																																																									
5' Bury	840.00	1,277.00																																																									
6' Bury	868.00	1,310.00																																																									
<p>71020</p> 	<p>HYDRASAN® I WITH VACUUM BREAKER MILD CLIMATE</p> <table border="1"> <thead> <tr> <th colspan="3">LIST PRICE</th> </tr> <tr> <th>SIZE</th> <th>3/4 F x 1" M</th> <th></th> </tr> </thead> <tbody> <tr> <td></td> <td></td> <td>\$638.00</td> </tr> </tbody> </table> <p>ADD FOR OPTIONS:</p> <table border="1"> <tbody> <tr> <td>-52</td> <td>\$28.00</td> <td>-74</td> <td>\$21.00</td> </tr> <tr> <td>-54</td> <td>129.00</td> <td>-91</td> <td>100.00</td> </tr> <tr> <td>-72</td> <td>0.00</td> <td>-95</td> <td>87.00</td> </tr> <tr> <td>-73</td> <td>0.00</td> <td></td> <td></td> </tr> </tbody> </table>	LIST PRICE			SIZE	3/4 F x 1" M				\$638.00	-52	\$28.00	-74	\$21.00	-54	129.00	-91	100.00	-72	0.00	-95	87.00	-73	0.00			<p>71600</p> 	<p>YARD HYDRANT, BOX TYPE NON-FREEZE</p> <table border="1"> <thead> <tr> <th colspan="3">LIST PRICE</th> </tr> <tr> <th>SIZE</th> <th>71600 3/4" Connection</th> <th>71600-91 1" Connection</th> </tr> </thead> <tbody> <tr> <td>2' Bury</td> <td>\$953.00</td> <td>\$1,103.00</td> </tr> <tr> <td>3' Bury</td> <td>1,025.00</td> <td>1,180.00</td> </tr> <tr> <td>4' Bury</td> <td>1,096.00</td> <td>1,256.00</td> </tr> <tr> <td>5' Bury</td> <td>1,176.00</td> <td>1,327.00</td> </tr> </tbody> </table> <p>ADD FOR OPTIONS:</p> <table border="1"> <tbody> <tr> <td>-52</td> <td>\$0.00</td> <td>-95</td> <td>\$87.00</td> </tr> <tr> <td>-91</td> <td>ABOVE</td> <td>-97</td> <td>87.00</td> </tr> </tbody> </table>	LIST PRICE			SIZE	71600 3/4" Connection	71600-91 1" Connection	2' Bury	\$953.00	\$1,103.00	3' Bury	1,025.00	1,180.00	4' Bury	1,096.00	1,256.00	5' Bury	1,176.00	1,327.00	-52	\$0.00	-95	\$87.00	-91	ABOVE	-97	87.00					
LIST PRICE																																																											
SIZE	3/4 F x 1" M																																																										
		\$638.00																																																									
-52	\$28.00	-74	\$21.00																																																								
-54	129.00	-91	100.00																																																								
-72	0.00	-95	87.00																																																								
-73	0.00																																																										
LIST PRICE																																																											
SIZE	71600 3/4" Connection	71600-91 1" Connection																																																									
2' Bury	\$953.00	\$1,103.00																																																									
3' Bury	1,025.00	1,180.00																																																									
4' Bury	1,096.00	1,256.00																																																									
5' Bury	1,176.00	1,327.00																																																									
-52	\$0.00	-95	\$87.00																																																								
-91	ABOVE	-97	87.00																																																								
<p>71050</p> 	<p>HYDRASAN® I WITH VACUUM BREAKER NON-FREEZE</p> <table border="1"> <thead> <tr> <th colspan="2">LIST PRICE</th> </tr> <tr> <th>SIZE</th> <th></th> </tr> </thead> <tbody> <tr> <td>2-3/4" Wall</td> <td>\$410.00</td> </tr> <tr> <td>4", 6", 8" Wall</td> <td>410.00</td> </tr> <tr> <td>10", 12", 14" Wall</td> <td>435.00</td> </tr> <tr> <td>16", 18" Wall</td> <td>475.00</td> </tr> <tr> <td>20", 22", 24" Wall</td> <td>515.00</td> </tr> </tbody> </table> <p>ADD FOR OPTIONS:</p> <table border="1"> <tbody> <tr> <td>-50</td> <td>\$0.00</td> <td>-74</td> <td>\$21.00</td> </tr> <tr> <td>-72</td> <td>0.00</td> <td>-91</td> <td>100.00</td> </tr> <tr> <td>-73</td> <td>0.00</td> <td></td> <td></td> </tr> </tbody> </table>	LIST PRICE		SIZE		2-3/4" Wall	\$410.00	4", 6", 8" Wall	410.00	10", 12", 14" Wall	435.00	16", 18" Wall	475.00	20", 22", 24" Wall	515.00	-50	\$0.00	-74	\$21.00	-72	0.00	-91	100.00	-73	0.00			<p>71650</p> 	<p>TRI-TEMP WALL HYDRANT, BOX TYPE NON-FREEZE</p> <table border="1"> <thead> <tr> <th colspan="3">LIST PRICE</th> </tr> <tr> <th>SIZE</th> <th>71650 3/4" Connection</th> <th>71650-91 1" Connection</th> </tr> </thead> <tbody> <tr> <td>6", 8" Wall</td> <td>\$1,807.00</td> <td>\$2,004.00</td> </tr> <tr> <td>10", 12", 14" Wall</td> <td>1,858.00</td> <td>2,055.00</td> </tr> <tr> <td>16", 18" Wall</td> <td>2,017.00</td> <td>2,214.00</td> </tr> <tr> <td>20", 22", 24" Wall</td> <td>2,118.00</td> <td>2,315.00</td> </tr> </tbody> </table> <p>ADD FOR OPTIONS:</p> <table border="1"> <tbody> <tr> <td>-72</td> <td>\$0.00</td> <td>-81</td> <td>\$66.00</td> </tr> <tr> <td>-73</td> <td>0.00</td> <td>-91</td> <td>ABOVE</td> </tr> <tr> <td>-74</td> <td>43.00</td> <td>-95</td> <td>87.00</td> </tr> </tbody> </table>	LIST PRICE			SIZE	71650 3/4" Connection	71650-91 1" Connection	6", 8" Wall	\$1,807.00	\$2,004.00	10", 12", 14" Wall	1,858.00	2,055.00	16", 18" Wall	2,017.00	2,214.00	20", 22", 24" Wall	2,118.00	2,315.00	-72	\$0.00	-81	\$66.00	-73	0.00	-91	ABOVE	-74	43.00	-95	87.00
LIST PRICE																																																											
SIZE																																																											
2-3/4" Wall	\$410.00																																																										
4", 6", 8" Wall	410.00																																																										
10", 12", 14" Wall	435.00																																																										
16", 18" Wall	475.00																																																										
20", 22", 24" Wall	515.00																																																										
-50	\$0.00	-74	\$21.00																																																								
-72	0.00	-91	100.00																																																								
-73	0.00																																																										
LIST PRICE																																																											
SIZE	71650 3/4" Connection	71650-91 1" Connection																																																									
6", 8" Wall	\$1,807.00	\$2,004.00																																																									
10", 12", 14" Wall	1,858.00	2,055.00																																																									
16", 18" Wall	2,017.00	2,214.00																																																									
20", 22", 24" Wall	2,118.00	2,315.00																																																									
-72	\$0.00	-81	\$66.00																																																								
-73	0.00	-91	ABOVE																																																								
-74	43.00	-95	87.00																																																								
<p>71070</p> 	<p>HYDRASAN® I WITH VACUUM BREAKER MILD CLIMATE</p> <table border="1"> <thead> <tr> <th colspan="3">LIST PRICE</th> </tr> <tr> <th>SIZE</th> <th>3/4 F x 1" M</th> <th></th> </tr> </thead> <tbody> <tr> <td></td> <td></td> <td>\$316.00</td> </tr> </tbody> </table> <p>ADD FOR OPTIONS:</p> <table border="1"> <tbody> <tr> <td>-50</td> <td>\$0.00</td> <td>-74</td> <td>\$21.00</td> </tr> <tr> <td>-72</td> <td>0.00</td> <td>-91</td> <td>100.00</td> </tr> <tr> <td>-73</td> <td>0.00</td> <td></td> <td></td> </tr> </tbody> </table>	LIST PRICE			SIZE	3/4 F x 1" M				\$316.00	-50	\$0.00	-74	\$21.00	-72	0.00	-91	100.00	-73	0.00			<p>Hydrant OPTION DESCRIPTIONS</p> <ul style="list-style-type: none"> -50 Satin Finish Bronze Face -52 Satin Finish Face, Cast Bronze Box -54 Satin Finish Face, Cast Nikaloy Box -72 Wall Clamp -73 Solder Inlet Adapter -74 Union Elbow Assembly -81 Vacuum Breaker -91 1" Hose Pipe Threaded Outlet -95 Cylinder Vandal-Proof Lock -97 1/8" Tapped Drain Hole in Box 																																				
LIST PRICE																																																											
SIZE	3/4 F x 1" M																																																										
		\$316.00																																																									
-50	\$0.00	-74	\$21.00																																																								
-72	0.00	-91	100.00																																																								
-73	0.00																																																										
<p>71400</p> 	<p>YARD HYDRANT NON-FREEZE</p> <table border="1"> <thead> <tr> <th colspan="2">LIST PRICE</th> </tr> <tr> <th>SIZE</th> <th>3/4" CONNECTION</th> </tr> </thead> <tbody> <tr> <td>2' Bury</td> <td>\$552.00</td> </tr> <tr> <td>3' Bury</td> <td>581.00</td> </tr> <tr> <td>4' Bury</td> <td>612.00</td> </tr> <tr> <td>5' Bury</td> <td>641.00</td> </tr> <tr> <td>6' Bury</td> <td>670.00</td> </tr> </tbody> </table>	LIST PRICE		SIZE	3/4" CONNECTION	2' Bury	\$552.00	3' Bury	581.00	4' Bury	612.00	5' Bury	641.00	6' Bury	670.00																																												
LIST PRICE																																																											
SIZE	3/4" CONNECTION																																																										
2' Bury	\$552.00																																																										
3' Bury	581.00																																																										
4' Bury	612.00																																																										
5' Bury	641.00																																																										
6' Bury	670.00																																																										

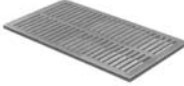
SHOCK ABSORBERS					
75000 	STAINLESS STEEL SHELL & ADAPTER		75000-S 	COPPER, PISTON TYPE	
	LIST PRICE			LIST PRICE	
	SIZE			SIZE	
A	\$262.00	AA	\$68.00		
B	530.00	A	106.00		
C	795.00	B	214.00		
D	1,991.00	C	323.00		
E	2,247.00	D	811.00		
F	2,762.00	E	969.00		
		F	1,124.00		

TRENCH DRAINS									
76000 	SUPER-FLO® 6" WIDE, RECTANGULAR			76010 	12" WIDE, RECTANGULAR				
	LIST PRICE				LIST PRICE				
	PIPE SIZE	2", 3", 4"	\$477.00		PIPE SIZE	3"-6"	\$1,119.00		
ADD FOR OPTIONS:			ADD FOR OPTIONS:						
-EXT	\$477.00	-VP	\$109.00	-EXT	\$1,119.00	-30	\$69.00		
-1	510.00	-30	71.00	-1	631.00	-40	295.00		
-2	440.00	-40	147.00	-2	544.00	-70	260.00		
-7	148.00	-X	0.00	-7	407.00	-70-40	422.00		
2" and 3" Provided as 4" -X with Reducer.			-11				86.00	-X	0.00
			-VP				109.00		
			3" Provided as 4" -X with Reducer.						
76300 76400 	LIGHT-DUTY RECTANGULAR TRENCH DRAIN & ADDITIONAL SECTIONS								
	LIST PRICES								
	OPTIONS	76300 20" GRATE	76301 SINGLE GRATE & FRAME	76302 2-GRATE SECTION	76302 ADD'L. 20" 1-GRATE SECTION	76402 24" 2-GRATE SECTION	7640 ADD'L. 12" SECTIONS		
	\$261.00	\$572.00	\$1,145.00	\$572.00	\$1,276.00	\$422.00			
ADD FOR OPTIONS:									
-1	\$982.00	\$1,576.00	\$2,498.00	\$922.00	\$2,597.00	\$1,301.00			
-7	289.00	579.00	1,158.00	579.00	1,158.00	579.00			
-8-2	875.00	1,378.00	2,196.00	819.00	2,290.00	1,193.00			
-VP	-----	216.00	432.00	216.00	432.00	216.00			
-40	147.00	224.00	448.00	224.00	448.00	215.00			
76500 76600 	MEDIUM-DUTY RECTANGULAR TRENCH DRAIN & ADDITIONAL SECTIONS								
	LIST PRICES								
	OPTIONS	76500 24" GRATE	76501 SINGLE GRATE & FRAME	76502 2-GRATE SECTION	76502 ADD'L. 24" 1-GRATE SECTION	76602 24" 2-GRATE SECTION	7660 ADD'L. 12" SECTIONS		
	\$333.00	\$903.00	\$1,393.00	\$876.00	\$1,669.00	\$765.00			
ADD FOR OPTIONS:									
-1	\$1,249.00	\$1,793.00	\$3,186.00	\$1,393.00	\$3,733.00	\$1,939.00			
-7	578.00	578.00	1,156.00	578.00	1,156.00	578.00			
-8-2	1,159.00	1,628.00	2,882.00	1,254.00	3,351.00	1,723.00			
-VP	-----	216.00	432.00	216.00	432.00	216.00			
-40	632.00	632.00	1,263.00	632.00	1,263.00	632.00			

TRENCH DRAINS (cont'd)





76700 76800 	HEAVY-DUTY RECTANGULAR TRENCH DRAIN & ADDITIONAL SECTIONS						
	LIST PRICES						
	OPTIONS	76700 24" GRATE	76701 SINGLE GRATE & FRAME	76702 2-GRATE SECTION	76702 ADD'L. 24" 1-GRATE SECTION	76802 24" 2-GRATE SECTION	7680 ADD'L. 12" SECTIONS
		\$589.00	\$1,217.00	\$2,125.00	\$907.00	\$1,770.00	\$769.00
ADD FOR OPTIONS:							
-1	\$1,897.00	\$2,981.00	\$5,628.00	\$2,648.00	\$4,864.00	\$2,017.00	
-7	624.00	624.00	1,248.00	624.00	1,248.00	624.00	
-8-2	1,753.00	2,619.00	5,022.00	2,405.00	4,313.00	1,807.00	
-VP	-----	216.00	432.00	216.00	432.00	216.00	
-40	709.00	709.00	1,418.00	709.00	1,418.00	709.00	

TRENCH DRAIN OPTION DESCRIPTIONS

-EXT	Extension Section	-30	Flashing Clamp Device
-VP	* Secured Grate, Vandal-Proof Screws	-40	Galvanized Cast Iron Parts
-1	Satin Finish Nikaloy Top	-70	Sediment Bucket
-2	Satin Finish Bronze Top	-70-40	Sediment Bucket, Galvanized
-7	Ductile Iron Grate		
-8-2	All Bronze with Satin Finish Top	Outlet	
-11	Convex Grate	-X	Inside Caulk Outlet









* For Installations Exposed to Vehicular Traffic, Specify -VP, Secured Grate





MISCELLANEOUS PRODUCTS

85220 	5" x 7" 90° ANGLE STRAINER			85810 	RECTANGULAR PATTERN DRAIN		
	LIST PRICE				LIST PRICE		
	PIPE SIZE	2", 3", 4"	\$760.00		PIPE SIZE	2", 3", 4"	\$224.00
ADD FOR OPTIONS:				ADD FOR OPTIONS:			
-3	\$309.00	-42	\$86.00	-1	\$277.00	-42	\$68.00
-VP	80.00	-47	270.00	-2	248.00	-47	227.00
-41	127.00	-T	0.00	-3	306.00	-T	36.00
				-VP	66.00	-X	0.00
85800 	RECTANGULAR PATTERN DRAIN			85903-Z  NEW	CAST IRON DRAIN WITH MEDIUM-DUTY SLOTTED GRATE		
	LIST PRICE				LIST PRICE		
	PIPE SIZE	4", 5", 6"	\$309.00		PIPE SIZE	3"	\$75.00
ADD FOR OPTIONS:				ADD FOR OPTIONS:			
-1	\$450.00	-42	\$68.00	-F4-93	\$79.00	-Z	0.00
-2	404.00	-47	270.00	-47	50.00		
-3	306.00	-T	0.00				
-VP	66.00						

MISCELLANEOUS PRODUCT OPTION DESCRIPTIONS

-F4-93	Round Cast Iron Funnel	Outlets	
-VP	Secured Grate, Vandal-Proof Screws	-T	Threaded Outlet
-1	Satin Finish Nikaloy Top	-X	Inside Caulk Outlet
-2	Satin Finish Bronze Top	-Z	No-Hub Outlet
-3	Chrome Plated Bronze Face		
-41	Clamp Device		
-42	Ground Screw		
-47	Galvanized Cast Iron Parts		

	P TRAP LIST PRICE			TRAP PRIMER ADAPTER LIST PRICE		
	PIPE SIZE			PIPE SIZE	2", 3", 4"	\$87.00
	2"	\$203.00	NEW			
	3"	309.00				
	4"	461.00				
	ADD FOR OPTIONS: -51 \$69.00 -60 \$93.00					
	DEEP SEAL TRAP, FUNNEL INLET LIST PRICE			HUB ADAPTER, THREADED OUTLET LIST PRICE		
	PIPE SIZE			PIPE SIZE		
	2"	\$337.00	3"	\$69.00		
	3"	390.00	4"	87.00		
			5"	180.00		
			6"	216.00		
	ADD FOR OPTIONS: -8 (2")..... \$263.00 -51 \$69.00 -8 (3")..... 585.00 -72 93.00		ADD FOR OPTIONS: -40 (3", 4") \$32.00 -40 (6")..... \$55.00 -40 (5")..... 48.00			
	TRAP SEAL PRIMER VALVE LIST PRICE			HUB ADAPTER, THREADED OUTLET LIST PRICE		
	88250	\$134.00		PIPE SIZE		
	ADD FOR OPTIONS: -10 \$43.00 -91 \$68.00 -90 0.00		2"	\$43.00		
			3"	81.00		
			4"	109.00		
			5"	180.00		
			6"	209.00		
			8"	383.00		
	ADD FOR OPTIONS: -40 (2"-4") \$36.00 -40 (5"-8")..... \$56.00					
	TRAP SEAL PRIMER VALVE LIST PRICE			REDUCING HUB ADAPTER LIST PRICE		
	88300	POA*		TYPE NO.	PIPE SIZE	
	• PRICE ON APPLICATION		88603-2	2"	\$113.00	
			88603-2-1/2	2-1/2"	119.00	
			88604-2	2"	119.00	
			88604-2-1/2	2-1/2"	119.00	
			88604-3	3"	120.00	
			88606-4	4"	255.00	
	ADD FOR OPTIONS: -40 \$39.00 -50 69.00 -49 69.00		ADD FOR OPTIONS: -40 \$36.00			
	NO-HUB SPIGOT ADAPTER LIST PRICE					
	PIPE SIZE					
	2"	\$43.00				
	3"	63.00				
	4"	100.00				
	6"	306.00				
	8"	342.00				

<p>88900</p> 	<p style="text-align: center;">AIR GAP</p> <table border="1" style="width: 100%;"> <thead> <tr> <th colspan="2" style="text-align: center;">LIST PRICE</th> </tr> <tr> <th style="text-align: left;">TYPE NO.</th> <th></th> </tr> </thead> <tbody> <tr> <td>88900-1</td> <td style="text-align: right;">\$138.00</td> </tr> <tr> <td>88900-2</td> <td style="text-align: right;">138.00</td> </tr> <tr> <td>88900-3</td> <td style="text-align: right;">166.00</td> </tr> <tr> <td>88900-4</td> <td style="text-align: right;">244.00</td> </tr> <tr> <td>88900-5</td> <td style="text-align: right;">577.00</td> </tr> </tbody> </table> <p>ADD FOR OPTIONS:</p> <p>-40 \$96.00</p>	LIST PRICE		TYPE NO.		88900-1	\$138.00	88900-2	138.00	88900-3	166.00	88900-4	244.00	88900-5	577.00	<p>OPTION DESCRIPTIONS</p> <p>-VP Secured Grate, Vandal-Proof Screws -2 Satin Finish Bronze Face -8 All Bronze -8-2 All Bronze with Satin Finish Face -10 Polished Chrome Plated -40 Galvanized Cast Iron Parts -49 3/4" Primer Tap -50 1/2" Primer Tap -51 Flushing Tap -60 Bronze Plug -72 Bronze Bucket -90 1/2" Female Copper Connection -91 1/2" Female IPS Union Connection</p>
LIST PRICE																
TYPE NO.																
88900-1	\$138.00															
88900-2	138.00															
88900-3	166.00															
88900-4	244.00															
88900-5	577.00															
<p>88910</p> 	<p style="text-align: center;">AIR GAP</p> <table border="1" style="width: 100%;"> <thead> <tr> <th colspan="2" style="text-align: center;">LIST PRICE</th> </tr> <tr> <th style="text-align: left;">TYPE NO.</th> <th></th> </tr> </thead> <tbody> <tr> <td>88910-1</td> <td style="text-align: right;">\$143.00</td> </tr> <tr> <td>88910-2</td> <td style="text-align: right;">143.00</td> </tr> <tr> <td>88910-3</td> <td style="text-align: right;">155.00</td> </tr> <tr> <td>88910-4</td> <td style="text-align: right;">199.00</td> </tr> <tr> <td>88910-5</td> <td style="text-align: right;">199.00</td> </tr> </tbody> </table> <p>ADD FOR OPTIONS:</p> <p>-40 \$96.00</p>	LIST PRICE		TYPE NO.		88910-1	\$143.00	88910-2	143.00	88910-3	155.00	88910-4	199.00	88910-5	199.00	
LIST PRICE																
TYPE NO.																
88910-1	\$143.00															
88910-2	143.00															
88910-3	155.00															
88910-4	199.00															
88910-5	199.00															
<p>88950</p> 	<p style="text-align: center;">FRESH AIR INLET</p> <table border="1" style="width: 100%;"> <thead> <tr> <th colspan="2" style="text-align: center;">LIST PRICE</th> </tr> <tr> <th style="text-align: left;">PIPE SIZE</th> <th></th> </tr> </thead> <tbody> <tr> <td>2", 3", 4"</td> <td style="text-align: right;">\$264.00</td> </tr> <tr> <td>5", 6"</td> <td style="text-align: right;">450.00</td> </tr> <tr> <td>8"</td> <td style="text-align: right;">719.00</td> </tr> </tbody> </table> <p>ADD FOR OPTIONS:</p> <p>-2 (2" - 4")..... Deduct \$40.00 -2 (8")..... Deduct \$171.00 -2 (5", 6") Deduct 97.00</p>	LIST PRICE		PIPE SIZE		2", 3", 4"	\$264.00	5", 6"	450.00	8"	719.00					
LIST PRICE																
PIPE SIZE																
2", 3", 4"	\$264.00															
5", 6"	450.00															
8"	719.00															
<p>88970</p> 	<p style="text-align: center;">FRESH AIR INLET</p> <table border="1" style="width: 100%;"> <thead> <tr> <th colspan="2" style="text-align: center;">LIST PRICE</th> </tr> <tr> <th style="text-align: left;">PIPE SIZE</th> <th></th> </tr> </thead> <tbody> <tr> <td>4"</td> <td style="text-align: right;">\$418.00</td> </tr> <tr> <td>5"</td> <td style="text-align: right;">476.00</td> </tr> </tbody> </table> <p>ADD FOR OPTIONS:</p> <p>-8-2 Deduct \$150.00 -VP 30.00</p>	LIST PRICE		PIPE SIZE		4"	\$418.00	5"	476.00							
LIST PRICE																
PIPE SIZE																
4"	\$418.00															
5"	476.00															

 NEW	PVC BODY WITH COLLAR		
	LIST PRICE		
	PIPE SIZE	2", 3", 4"	\$87.00
ADD FOR OPTIONS:			
-MD	\$50.00	-50	STD
-49	0.00	-S	0.00

 NEW	COMBINATION 3" x 4" PVC BODY FOR USE WITH ALL JOSAM STRAINERS		
	LIST PRICE		
	PIPE SIZE	3", 4"	\$30.00
ADD FOR OPTIONS:			
-S	\$0.00		

 A Strainer	ROUND NIKALOY SUPER-FLO® STRAINERS FOR PVC BODIES			
	LIST PRICE			
	Strainer	Strainer Only	With 30000-PVC	With 30300-PVC
5A	\$133.00	\$220.00	\$163.00	
6A	183.00	270.00	213.00	
7A	225.00	312.00	255.00	
8A	305.00	392.00	335.00	
9A	448.00	535.00	478.00	
10A	448.00	535.00	478.00	
ADD FOR OPTIONS:				
-SS (5A-8A)	\$0.00	-80	\$50.00	
-2 (5A)	Deduct 11.00	-5A-CP	20.00	
-2 (6A)	Deduct 27.00	-6A-CP	22.00	
-2 (7A)	Deduct 16.00	-J	174.00	
-2 (8A)	Deduct 21.00	-VP	25.00	
-2 (9A, 10A)	Deduct 28.00			

 S Strainer	SQUARE NIKALOY SUPER-FLO® STRAINERS FOR PVC BODIES			
	LIST PRICE			
	Strainer	Strainer Only	With 30000-PVC	With 30300-PVC
5S	\$208.00	\$295.00	\$238.00	
6S	242.00	329.00	272.00	
8S	390.00	477.00	420.00	
9S	519.00	606.00	549.00	
ADD FOR OPTIONS:				
-SS (5S-8S)	\$0.00	-80	\$50.00	
-2 (5S)	Deduct 25.00	-5S-CP	25.00	
-2 (6S)	Deduct 16.00	-6S-CP	30.00	
-2 (8S)	Deduct 44.00	-J	174.00	
-2 (9S)	Deduct 50.00	-VP	25.00	

 NEW	PVC DRAIN ASSEMBLY, 9" ROUND TOP		
	LIST PRICE		
	PIPE SIZE	2", 3", 4"	\$170.00
ADD FOR OPTIONS:			
-HG	\$0.00	-50	\$50.00
-B	30.00	-S	0.00
-49	50.00		

 NEW	PVC DRAIN ASSEMBLY, 8" SQUARE CAST IRON TOP		
	LIST PRICE		
	PIPE SIZE	2", 3", 4"	\$295.00
ADD FOR OPTIONS:			
-1	\$282.00	-49	\$50.00
-2	209.00	-50	50.00
-15	109.00	-S	0.00

 NEW	PVC DRAIN ASSEMBLY, 12" SQUARE CAST IRON TOP		
	LIST PRICE		
	PIPE SIZE	2", 3", 4"	\$575.00
ADD FOR OPTIONS:			
-14	\$109.00	-20	\$418.00
-VP	66.00	-49	50.00
-18	253.00	-50	50.00
-19	505.00	-S	0.00

 NEW	PVC BODY/DOME ASSEMBLY WITH FULL GRATE		
	LIST PRICE		
	PIPE SIZE	2", 3", 4"	\$230.00
ADD FOR OPTIONS:			
-LG	Deduct \$100.00	-VP (NB)	\$35.00
-HG	0.00	-16	195.00
-3Q	0.00	-17	288.00
-NB	347.00	-18	405.00
-3	0.00	-24	99.00
-4	0.00	-50	87.00
-5	501.00	-S	0.00
-7	81.00		

 NEW	COMBINATION 3" x 4" PVC ADJUSTABLE FLOOR CLEANOUT		
	LIST PRICE		
	PIPE SIZE	3" x 4"	\$250.00
ADD FOR OPTIONS:			
-2	Deduct \$17.00	-VP	\$43.00
-14	36.00	-S	0.00

OPTION DESCRIPTIONS

- B Bucket
- CP Chrome Plated
- HG 1/2 Grate, PVC
- J Backwater Valve
- LG Less Grate
- MD PVC Clamp Collar with 3" Socket Connection
- NB Nickel Bronze Traffic Top
- SS Stainless Steel
- VP Secured Grate, Vandal-Proof Screws
- 1 Satin Finish Nikaloy Top
- 2 Satin Finish Bronze Top
- 3 1/2 Grate, Nickel Bronze
- 3Q 3/4 Grate, PVC
- 4 3/4 Grate, Nickel Bronze
- 5 Nikaloy Extra Heavy-Duty Grate & Rim
- 7 Full Grate with 2-1/2" Center Opening
- 14 Hinged Top (on 37800-PVC)
- 14 Carpet Cleanout Marker (on 58360-PVC)
- 15 Chained Grate
- 16 Grate with 4" Round Funnel, NB Only
- 17 Grate with 6" Round Funnel, NB Only
- 18 Grate with 9" x 3-1/2" Oval Funnel, NB Only
- 19 CI Undergrate with Satin Finish Nikaloy Top
- 20 CI Undergrate with Satin Finish Bronze Top
- 24 Chained Grate, NB Only
- 49 3/4" Primer Tap
- 50 1/2" Primer Tap
- 80 Perforated Stainless Steel Basket

Outlet

- S Solvent Weld Outlet for Schedule 40 PVC Pipe



Prepackaged Products **ALWAYS AT JOSAM**

- *Hardware included in each package*
- *Durable and water resistant*
- *Customized labels for specific job requirements*
- *Quick and Easy Product Identification*
- *Accurate and on time shipping*

JOSAM COMPANY | www.josam.com

CUSTOMER SERVICE CENTERS

JOSAM CORPORATE
525 West Highway 20
Michigan City, IN 46360
800.36.JOSAM | F 800.627.0008

JOSAM EXECUTIVE
2501 S Front Street,
Philadelphia, PA 19148
215.339.5370 | F 800.962.3312

JOSAM WEST
2333 Grant Ave,
San Lorenzo, CA 94580
510.481.6400 | F 800.995.6726