

# Josam Specification Drainage Products Catalog

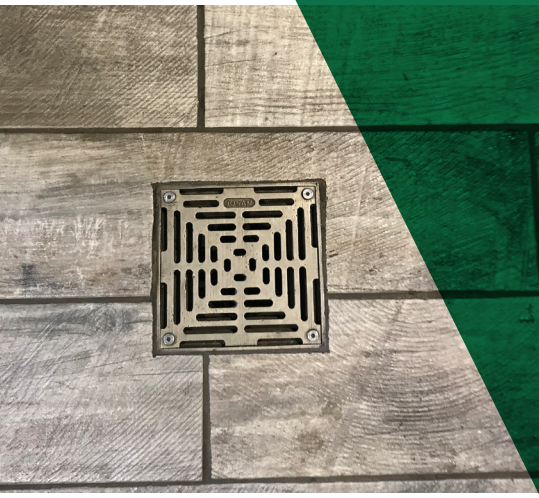

# Josam also offers Stainless Steel Push-Fit Pipe & Fittings, a complete line of Stainless Steel Drains, and the PRO-PLUS® Trench Drain System.

## Stainless Steel Push-Fit Drainage System



- Made of austenitic grade 316L Stainless Steel
- Gasketed "Push-Fit" design for cost effective installations
- 1 1/2" through 8" pipe size
- Specific gasket materials for different product applications
- Pressure ratings at least four times higher than previous generation systems
- Capable of being used in vacuum systems
- Corrosion, Fire, Heat, Impact, & Thermal Stress Resistance
- Strong and Lightweight

## Stainless Steel Drainage Products



- 8", 10", and 12" adjustable and non-adjustable round top floor drains
- 6", 8", 10", 12", and 16" adjustable and non-adjustable square top floor drains
- 2" through 8" no-hub outlets for easy connection to existing piping
- 6", 8", 12", and 16" wide trench drains
- Grates for the lightest to heaviest of loads
- 5/16", 3/4", and 3" slot and mini channels
- Ability to customize products to meet project installation requirements

## PRO-PLUS® Trench Drain System

- SMC/GRP Construction
- 1.5 times stronger than polymer concrete
- 70% Lighter than polymer concrete
- Shatterproof
- Available with and without slope
- 4" and 8" nominal interior widths
- Load Class A-F



For more information on these quality engineered drainage products, please visit [www.josam.com](http://www.josam.com) or contact your local Josam representative.

## TABLE OF CONTENTS

### Specification Products

Closet Carriers .....	2-3
Fixture Carriers.....	4-5
Roof Drains .....	5-9
Floor Drains.....	10-18
Sanitary Floor Sinks.....	19-20
Stainless Steel Retrofit Liners for Sanitary Floor Sinks.....	21
Cleanouts.....	22-24
Interceptors.....	25-29
Backwater Valves .....	30
Hydrants .....	31
Shock Absorbers .....	32
Trench Drains.....	32
Miscellaneous Products .....	33
Traps & Accessories.....	34-35

### Lite Line Products

Floor Drains.....	36-38
Roof Drains .....	38
Floor Sinks .....	39
Cleanouts.....	39
Interceptors.....	40
Shock Absorbers .....	40
Shallow Trench Drain Products.....	40

Every product in this catalog is provided with its options in a concise table. The description of each option is shown in the lower right corner of each page spread. A thumbnail photo is included for quick identification. All drawings and dimensions are available at [www.Josam.com](http://www.Josam.com).



*Partial or Full Domestic Content  
on Specification Product Line  
available upon request.*

# CLOSET CARRIERS



A WATTS Brand

**11001**  
**11007**

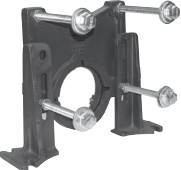

**CLOSET CARRIERS**

**LIST PRICE**

**SERIES NO.**  
11001 w/ 4" Pipe Grip Adapter  
11007 w/ 3" Copper Ftg. Adapter

**ADD FOR OPTIONS:**

-35\*

\*Not Available on 11007.

**12673**  
**12674**



**3" HORIZONTAL NO-HUB ADJUSTABLE**

**LIST PRICE**

**3" Pipe Connections**

SERIES NO.	12673 Single L.H.	12683 Single R.H.	12693 Back-to-Back
No-Hub			

**12683**  
**12684**

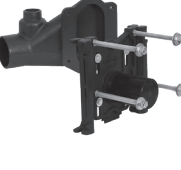

**4" HORIZONTAL NO-HUB ADJUSTABLE**

**LIST PRICE**

**4" Pipe Connections**

SERIES NO.	12674 Single L.H.	12684 Single R.H.	12694 Back-to-Back
No-Hub			
-HS			
-58			
-HS-58			

**12693**  
**12694**

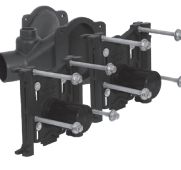

**ADD FOR OPTIONS:**

-1*	-HS†
-6*	-OR
-6CU*	-PAC
-10	-PAF
-24*	-PF
-30	-PFG
-30-2	-PS
-32*	-SDH (750 LB.)*
-35	-TB*
-58†	-VP*
-AUX**	-XSD (1000 LB.)*
-CR	

\*Pricing for options is per fixture. Add or subtract twice for Back-to-Back Carriers

\*\* Not Available on 12694

† Not Available on 12673, 12683, and 12693

**12704**  
**12714**

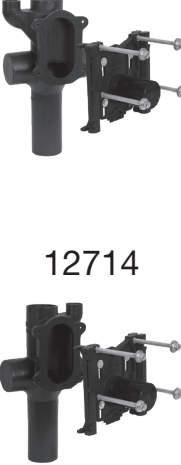

**VERTICAL ADJUSTABLE SINGLE, NO-HUB, ON STACK**

**LIST PRICE**

SERIES NO.	No-Hub	-HS
12704 L.Hand 2" Vent		
12714 R.Hand 2" Vent		

**ADD FOR OPTIONS:**

-1	-HD4
-6	-HLH4
-6CU	-HRH4
-10	-HS
-24	-LH4
-30	-OR
-30-2	-PAC
-32	-PAF
-35	-PF
-49	-PFG
-50	-PS
-53	-RH4
-54	-SDH (750 lb.)
-58	-TB
-CR	-VP
-D4	-XSD (1000 lb.)

**12724**

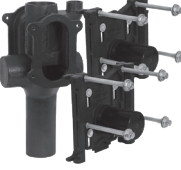

**VERTICAL ADJUSTABLE BACK-TO-BACK, NO-HUB, ON STACK**

**LIST PRICE**

SERIES NO.	No-Hub	-HS
12724 Back-to-Back 2" Vent		

**ADD FOR OPTIONS:**

-1	-HS
-6	-HD4
-6CU	-HVS4
-10	-OR
-24	-OS4
-30	-PAC
-30-2	-PAF
-32	-PF
-35	-PFG
-49	-PS
-50	-SDH (750 LB.)
-53	-TB
-54	-VP
-58	-VS4
-CR	-XSD (1000 lb.)
-D4	

**14004**  
**14024**  
**14044**



**VERTICAL CLOSE HUB & SPIGOT, OFFSET**

**LIST PRICE**

SERIES NO.	
14004 Sgl. L.H., L.H. 2" Vent	
14024 Sgl. R.H., R.H. 2" Vent	
14044 Back-to-Back, 2" Vent	











**ADD FOR OPTIONS:**

-1*	-54
-6*	-VP*
-6CU*	-XSD (1000 lb.)*
-21*	

\* Pricing for options is per fixture. Add or subtract twice for Back-to-Back Carriers

**Option Descriptions**









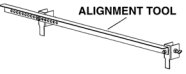

-AUX	Auxiliary Inlet, 2"	-1	Positioning Frame
-CR	Compression Ring Carrier	-6	Supply Pipe Support - Galvanized Pipe
-D4	Double 4" No-Hub Branches	-6CU	Supply Pipe Support - Copper Pipe
-HD4	Double 4" Hub Branches	-10	ABS Extension through 10-1/2" Wall
-HLH4	Left-Hand 4" Hub Branch	-21	Hanger Type Closet Adapter
-HRH4	Right-Hand 4" Hub Branch	-24	Carrier for Floor-Mounted, Back-Outlet China Bowls
-HS	Hub & Spigot	-30	Cast Iron Adjustable Extension with Connector
-HVS4	Vent Side 4" Hub Branch	-30-2	Cast Iron Adjustable Extension with Connector and Test Cap
-6CU	Supply Pipe Support - Copper	-32	Carrier for Wide Chase Installations
-LH4	Left-Hand 4" No-Hub Branch	-35	Closet Carrier for Wheelchair High Rough
-OR	O-Ring Carrier	-49	No-Hub High Auxiliary Inlet, Under Vent
-OS4	Opposite Vent 4" No-Hub Branch	-50	No-Hub High Auxiliary Inlet, Opposite Vent
-PAC	Pre-Assembled Carrier	-53	Threaded High Auxiliary Inlet, Under Vent
-PAF	Prefab Adjustable Foot	-54	Threaded High Auxiliary Inlet, Opposite Vent
-PF	Pylon Foot, Standard	-58	Horizontal No-Hub Cast Long Barrel
-PFG	Alternate Prefab Faceplate Gasket (Standard with PAF)		
-PS	Foam Sleeve for Extension		
-RH4	Right-Hand 4" No-Hub Branch		
-SDH	Special-Duty 750 lb. Carrier		
-TB	Test Bracket		
-VP	Vandal-Proof Trim		
-VS4	Vent Side 4" No-Hub Branch		
-XSD	Extra Special-Duty 1,000 lb. Carrier		

<p><b>14064</b></p>  <p><b>14104</b></p> 	<p style="text-align: center;"><b>VERTICAL CLOSE HUB &amp; SPIGOT, ON STACK</b></p> <p style="text-align: center;"><b>LIST PRICE</b></p> <table border="1"> <thead> <tr> <th colspan="2">SERIES NO.</th> </tr> </thead> <tbody> <tr> <td>14064 Sgl., 4" Vent</td> <td></td> </tr> <tr> <td>14104 Sgl., 2" Vent</td> <td></td> </tr> </tbody> </table> <p><b>ADD FOR OPTIONS:</b></p> <table border="1"> <tbody> <tr> <td>-1 .....</td> <td>-SDH (750 lb.).....</td> </tr> <tr> <td>-6 .....</td> <td>-XSD (1000 lb.).....</td> </tr> <tr> <td>-6CU.....</td> <td>-VP .....</td> </tr> <tr> <td>-45 .....</td> <td></td> </tr> <tr> <td>-46 .....</td> <td></td> </tr> </tbody> </table>	SERIES NO.		14064 Sgl., 4" Vent		14104 Sgl., 2" Vent		-1 .....	-SDH (750 lb.).....	-6 .....	-XSD (1000 lb.).....	-6CU.....	-VP .....	-45 .....		-46 .....		<p><b>15964</b></p> 	<p style="text-align: center;"><b>90° INSTITUTIONAL FITTING VERTICAL NO-HUB, ON STACK</b></p> <p style="text-align: center;"><b>LIST PRICE</b></p> <table border="1"> <thead> <tr> <th colspan="2">SERIES NO.</th> </tr> </thead> <tbody> <tr> <td>15964 Double Waste Fitting with Vent and Carriers</td> <td></td> </tr> </tbody> </table> <p><b>ADD FOR OPTIONS:</b></p> <table border="1"> <tbody> <tr> <td>-1 .....</td> <td>-30-2.....</td> </tr> <tr> <td>-6 .....</td> <td>-49 .....</td> </tr> <tr> <td>-6CU.....</td> <td>-54 .....</td> </tr> <tr> <td>-10 .....</td> <td>-VP .....</td> </tr> <tr> <td>-24 .....</td> <td>-XSD (1000 lb.).....</td> </tr> <tr> <td>-26 .....</td> <td></td> </tr> <tr> <td>-30 .....</td> <td></td> </tr> </tbody> </table>	SERIES NO.		15964 Double Waste Fitting with Vent and Carriers		-1 .....	-30-2.....	-6 .....	-49 .....	-6CU.....	-54 .....	-10 .....	-VP .....	-24 .....	-XSD (1000 lb.).....	-26 .....		-30 .....	
SERIES NO.																																					
14064 Sgl., 4" Vent																																					
14104 Sgl., 2" Vent																																					
-1 .....	-SDH (750 lb.).....																																				
-6 .....	-XSD (1000 lb.).....																																				
-6CU.....	-VP .....																																				
-45 .....																																					
-46 .....																																					
SERIES NO.																																					
15964 Double Waste Fitting with Vent and Carriers																																					
-1 .....	-30-2.....																																				
-6 .....	-49 .....																																				
-6CU.....	-54 .....																																				
-10 .....	-VP .....																																				
-24 .....	-XSD (1000 lb.).....																																				
-26 .....																																					
-30 .....																																					
<p><b>14404</b></p>  <p><b>14424</b> (R.H. Not Shown)</p> <p><b>14444</b></p> 	<p style="text-align: center;"><b>VERTICAL CLOSE NO-HUB, OFFSET</b></p> <p style="text-align: center;"><b>LIST PRICE</b></p> <table border="1"> <thead> <tr> <th colspan="2">SERIES NO.</th> </tr> </thead> <tbody> <tr> <td>14404 Sgl. L.H., L.H. 2" Vent</td> <td></td> </tr> <tr> <td>14424 Sgl. R.H., R.H. 2" Vent</td> <td></td> </tr> <tr> <td>14444 Back-to-Back, 2" Vent</td> <td></td> </tr> </tbody> </table> <p><b>ADD FOR OPTIONS:</b></p> <table border="1"> <tbody> <tr> <td>-1*.....</td> <td>-30-2.....</td> </tr> <tr> <td>-6*.....</td> <td>-50 .....</td> </tr> <tr> <td>-6CU* .....</td> <td>-54 .....</td> </tr> <tr> <td>-10 .....</td> <td>-SDH (750 lb.).....</td> </tr> <tr> <td>-24*.....</td> <td>-XSD (1000 lb.).....</td> </tr> <tr> <td>-30 .....</td> <td>-VP* .....</td> </tr> </tbody> </table> <p>* Pricing for options is per fixture. Add or subtract twice for Back-to-Back Carriers</p>	SERIES NO.		14404 Sgl. L.H., L.H. 2" Vent		14424 Sgl. R.H., R.H. 2" Vent		14444 Back-to-Back, 2" Vent		-1*.....	-30-2.....	-6*.....	-50 .....	-6CU* .....	-54 .....	-10 .....	-SDH (750 lb.).....	-24*.....	-XSD (1000 lb.).....	-30 .....	-VP* .....	<p><b>15984</b></p> 	<p style="text-align: center;"><b>90° INSTITUTIONAL FITTING VERTICAL NO-HUB, ON STACK</b></p> <p style="text-align: center;"><b>LIST PRICE</b></p> <table border="1"> <thead> <tr> <th colspan="2">SERIES NO.</th> </tr> </thead> <tbody> <tr> <td>15984 Double Waste Fitting, No-Hub Branches, 2" Vent</td> <td></td> </tr> </tbody> </table> <p><b>ADD FOR OPTIONS:</b></p> <table border="1"> <tbody> <tr> <td>-26 .....</td> <td>-54 .....</td> </tr> <tr> <td>-49 .....</td> <td></td> </tr> </tbody> </table>	SERIES NO.		15984 Double Waste Fitting, No-Hub Branches, 2" Vent		-26 .....	-54 .....	-49 .....							
SERIES NO.																																					
14404 Sgl. L.H., L.H. 2" Vent																																					
14424 Sgl. R.H., R.H. 2" Vent																																					
14444 Back-to-Back, 2" Vent																																					
-1*.....	-30-2.....																																				
-6*.....	-50 .....																																				
-6CU* .....	-54 .....																																				
-10 .....	-SDH (750 lb.).....																																				
-24*.....	-XSD (1000 lb.).....																																				
-30 .....	-VP* .....																																				
SERIES NO.																																					
15984 Double Waste Fitting, No-Hub Branches, 2" Vent																																					
-26 .....	-54 .....																																				
-49 .....																																					
<p><b>14464</b></p>  <p><b>14484</b></p> 	<p style="text-align: center;"><b>VERTICAL CLOSE NO-HUB, ON STACK</b></p> <p style="text-align: center;"><b>LIST PRICE</b></p> <table border="1"> <thead> <tr> <th colspan="2">SERIES NO.</th> </tr> </thead> <tbody> <tr> <td>14464 Single, 4" Vent</td> <td></td> </tr> <tr> <td>14484 Back-to-Back, 4" Vent Siphon Jet Closets Only</td> <td></td> </tr> </tbody> </table> <p><b>ADD FOR OPTIONS:</b></p> <table border="1"> <tbody> <tr> <td>-1*.....</td> <td>-45 .....</td> </tr> <tr> <td>-6*.....</td> <td>-46 .....</td> </tr> <tr> <td>-6CU* .....</td> <td>-SDH (750 lb.).....</td> </tr> <tr> <td>-10 .....</td> <td>-VP* .....</td> </tr> <tr> <td>-24*.....</td> <td>-XSD (1000 lb.).....</td> </tr> <tr> <td>-30 .....</td> <td></td> </tr> <tr> <td>-30-2.....</td> <td></td> </tr> </tbody> </table> <p>* Pricing for options is per fixture. Add or subtract twice for Back-to-Back Carriers</p>	SERIES NO.		14464 Single, 4" Vent		14484 Back-to-Back, 4" Vent Siphon Jet Closets Only		-1*.....	-45 .....	-6*.....	-46 .....	-6CU* .....	-SDH (750 lb.).....	-10 .....	-VP* .....	-24*.....	-XSD (1000 lb.).....	-30 .....		-30-2.....		<p><b>16123</b></p> 	<p style="text-align: center;"><b>FLOOR-MOUNT PVC ADAPTER TYPE, ON STACK</b></p> <p style="text-align: center;"><b>LIST PRICE</b></p> <table border="1"> <thead> <tr> <th colspan="2">SERIES NO.</th> </tr> </thead> <tbody> <tr> <td>16123 Single, for PVC Pipe Siphon Jet Closets Only</td> <td></td> </tr> </tbody> </table> <p><b>ADD FOR OPTIONS:</b></p> <table border="1"> <tbody> <tr> <td>-1 .....</td> <td>-13 .....</td> </tr> <tr> <td>-6 .....</td> <td>-21 .....</td> </tr> <tr> <td></td> <td>-VP .....</td> </tr> </tbody> </table>	SERIES NO.		16123 Single, for PVC Pipe Siphon Jet Closets Only		-1 .....	-13 .....	-6 .....	-21 .....		-VP .....				
SERIES NO.																																					
14464 Single, 4" Vent																																					
14484 Back-to-Back, 4" Vent Siphon Jet Closets Only																																					
-1*.....	-45 .....																																				
-6*.....	-46 .....																																				
-6CU* .....	-SDH (750 lb.).....																																				
-10 .....	-VP* .....																																				
-24*.....	-XSD (1000 lb.).....																																				
-30 .....																																					
-30-2.....																																					
SERIES NO.																																					
16123 Single, for PVC Pipe Siphon Jet Closets Only																																					
-1 .....	-13 .....																																				
-6 .....	-21 .....																																				
	-VP .....																																				
<p><b>14504</b></p> 	<p style="text-align: center;"><b>VERTICAL CLOSE NO-HUB, ON STACK</b></p> <p style="text-align: center;"><b>LIST PRICE</b></p> <table border="1"> <thead> <tr> <th colspan="2">SERIES NO.</th> </tr> </thead> <tbody> <tr> <td>14504 Single, 2" Vent</td> <td></td> </tr> </tbody> </table> <p><b>ADD FOR OPTIONS:</b></p> <table border="1"> <tbody> <tr> <td>-1 .....</td> <td>-45 .....</td> </tr> <tr> <td>-6 .....</td> <td>-46 .....</td> </tr> <tr> <td>-6CU.....</td> <td>-SDH (750 lb.).....</td> </tr> <tr> <td>-10 .....</td> <td>-VP .....</td> </tr> <tr> <td>-24 .....</td> <td>-XSD (1000 lb.).....</td> </tr> <tr> <td>-30 .....</td> <td></td> </tr> <tr> <td>-30-2.....</td> <td></td> </tr> </tbody> </table>	SERIES NO.		14504 Single, 2" Vent		-1 .....	-45 .....	-6 .....	-46 .....	-6CU.....	-SDH (750 lb.).....	-10 .....	-VP .....	-24 .....	-XSD (1000 lb.).....	-30 .....		-30-2.....		<p style="text-align: center;"><b>Closet Carrier Option Descriptions</b></p> <ul style="list-style-type: none"> <li>-SDH Special-Duty 750 lb. Carrier</li> <li>-XSD Extra Special-Duty 1,000 lb. Carrier</li> <li>-VP Vandal-Proof Trim</li> <li>-1 Positioning Frame</li> <li>-6 Supply Pipe Support - Galvanized Pipe</li> <li>-6CU Supply Pipe Support - Copper Pipe</li> <li>-10 ABS Extension through 10-1/2" Wall</li> <li>-13 3" ABS Fitting Adapter</li> <li>-21 Hanger Type Closet Adapter</li> <li>-24 Carrier for Floor-Mounted, Back-Outlet China Bowls</li> <li>-26 Fitting Anchor Foot</li> <li>-30 Cast Iron Adjustable Extension with Connector</li> <li>-30-2 Cast Iron Adjustable Extension with Connector and Test Cap</li> <li>-45 Threaded Left-Hand Auxiliary Inlet</li> <li>-46 Threaded Right-Hand Auxiliary Inlet</li> <li>-49 No-Hub High Auxiliary Inlet, Under Vent</li> <li>-50 No-Hub High Auxiliary Inlet, Opposite Vent</li> <li>-54 Threaded High Auxiliary Inlet, Opposite Vent</li> </ul>																	
SERIES NO.																																					
14504 Single, 2" Vent																																					
-1 .....	-45 .....																																				
-6 .....	-46 .....																																				
-6CU.....	-SDH (750 lb.).....																																				
-10 .....	-VP .....																																				
-24 .....	-XSD (1000 lb.).....																																				
-30 .....																																					
-30-2.....																																					

# FIXTURE CARRIERS



A WATTS Brand

 <p><b>17000</b></p>	<p><b>REUSABLE ALIGNMENT TOOL</b></p> <table border="1"> <tr><th colspan="3">LIST PRICE</th></tr> <tr> <td>TYPE NO.</td> <td>17000</td> <td></td> </tr> </table>	LIST PRICE			TYPE NO.	17000		 <p><b>17380</b></p>	<p><b>FLOOR-MOUNT ADJUSTABLE EXPOSED ARMS</b></p> <table border="1"> <tr><th colspan="3">LIST PRICE</th></tr> <tr> <td>TYPE NO.</td> <td>17380</td> <td>17380-BB</td> </tr> <tr> <td colspan="3">ADD FOR OPTIONS:</td> </tr> <tr> <td>-10*</td> <td></td> <td></td> </tr> <tr> <td>-60</td> <td></td> <td></td> </tr> <tr> <td>-66**</td> <td></td> <td></td> </tr> <tr> <td>-BB**</td> <td></td> <td></td> </tr> <tr> <td>-HD</td> <td></td> <td></td> </tr> <tr> <td>-VP</td> <td></td> <td></td> </tr> </table> <p>* Hardware for Walls over 4-1/2", Specify Wall Thickness, Price Per Inch ** -66 cannot be Furnished with -BB.</p>	LIST PRICE			TYPE NO.	17380	17380-BB	ADD FOR OPTIONS:			-10*			-60			-66**			-BB**			-HD			-VP																																			
LIST PRICE																																																																					
TYPE NO.	17000																																																																				
LIST PRICE																																																																					
TYPE NO.	17380	17380-BB																																																																			
ADD FOR OPTIONS:																																																																					
-10*																																																																					
-60																																																																					
-66**																																																																					
-BB**																																																																					
-HD																																																																					
-VP																																																																					
 <p><b>17100</b></p>	<p><b>FLOOR-MOUNT ADJUSTABLE CONCEALED ARMS</b></p> <table border="1"> <tr><th colspan="3">LIST PRICE</th></tr> <tr> <td>TYPE NO.</td> <td>17100</td> <td>17100-BB</td> </tr> <tr> <td colspan="3">ADD FOR OPTIONS:</td> </tr> <tr> <td>-10*</td> <td></td> <td></td> </tr> <tr> <td>-60</td> <td></td> <td></td> </tr> <tr> <td>-67</td> <td></td> <td></td> </tr> <tr> <td>-75</td> <td></td> <td></td> </tr> <tr> <td>-76</td> <td></td> <td></td> </tr> <tr> <td>-77</td> <td></td> <td></td> </tr> <tr> <td>-BB</td> <td></td> <td></td> </tr> <tr> <td>-S**</td> <td>----</td> <td></td> </tr> <tr> <td>-T**</td> <td>----</td> <td></td> </tr> <tr> <td>-U**</td> <td>----</td> <td></td> </tr> <tr> <td>-V**</td> <td>----</td> <td></td> </tr> <tr> <td>-W**</td> <td>----</td> <td></td> </tr> <tr> <td>-X**</td> <td>----</td> <td></td> </tr> <tr> <td>-Y**</td> <td>----</td> <td></td> </tr> <tr> <td>-Z**</td> <td>----</td> <td></td> </tr> </table> <p>*Extension Sleeves Longer than 6-1/2", Specify Wall Thickness, Price Per Inch **Wall Thickness (inches) Suffix Wall Thickness (inches) Suffix 4-1/2 to 5 S 8-1/16 to 9 W 5-1/16 to 6 T 9-1/16 to 10 X 6-1/16 to 7 U 10-1/16 to 11 Y 7-1/16 to 8 V 11-1/16 to 12 Z</p>	LIST PRICE			TYPE NO.	17100	17100-BB	ADD FOR OPTIONS:			-10*			-60			-67			-75			-76			-77			-BB			-S**	----		-T**	----		-U**	----		-V**	----		-W**	----		-X**	----		-Y**	----		-Z**	----		 <p><b>17390</b></p>	<p><b>WALL-MOUNT ADJUSTABLE EXPOSED ARMS</b></p> <table border="1"> <tr><th colspan="3">LIST PRICE</th></tr> <tr> <td>TYPE NO.</td> <td>17390</td> <td></td> </tr> <tr> <td colspan="3">ADD FOR OPTIONS:</td> </tr> <tr> <td>-10*.....</td> <td>-BP.....</td> <td>-VP.....</td> </tr> </table> <p>* Hardware for Walls over 4-1/2", Specify Wall Thickness, Price Per Inch</p>	LIST PRICE			TYPE NO.	17390		ADD FOR OPTIONS:			-10*.....	-BP.....	-VP.....
LIST PRICE																																																																					
TYPE NO.	17100	17100-BB																																																																			
ADD FOR OPTIONS:																																																																					
-10*																																																																					
-60																																																																					
-67																																																																					
-75																																																																					
-76																																																																					
-77																																																																					
-BB																																																																					
-S**	----																																																																				
-T**	----																																																																				
-U**	----																																																																				
-V**	----																																																																				
-W**	----																																																																				
-X**	----																																																																				
-Y**	----																																																																				
-Z**	----																																																																				
LIST PRICE																																																																					
TYPE NO.	17390																																																																				
ADD FOR OPTIONS:																																																																					
-10*.....	-BP.....	-VP.....																																																																			
 <p><b>17120</b></p>	<p><b>WALL-MOUNT ADJUSTABLE CONCEALED ARMS</b></p> <table border="1"> <tr><th colspan="3">LIST PRICE</th></tr> <tr> <td>TYPE NO.</td> <td>17120</td> <td></td> </tr> <tr> <td colspan="3">ADD FOR OPTIONS:</td> </tr> <tr> <td>-10*.....</td> <td>-77.....</td> <td></td> </tr> <tr> <td>-67.....</td> <td>-BB.....</td> <td></td> </tr> <tr> <td>-75.....</td> <td>-MMB.....</td> <td></td> </tr> <tr> <td>-76.....</td> <td></td> <td></td> </tr> </table> <p>* Extension Sleeves Longer than 4", Specify Wall Thickness, Price Per Inch</p>	LIST PRICE			TYPE NO.	17120		ADD FOR OPTIONS:			-10*.....	-77.....		-67.....	-BB.....		-75.....	-MMB.....		-76.....			 <p><b>17405</b></p>	<p><b>WALL-MOUNT EXPOSED ARMS ONLY</b></p> <table border="1"> <tr><th colspan="3">LIST PRICE</th></tr> <tr> <td>TYPE NO.</td> <td>17405</td> <td></td> </tr> <tr> <td colspan="3">ADD FOR OPTIONS:</td> </tr> <tr> <td>-10*.....</td> <td>-7VP.....</td> <td></td> </tr> </table> <p>* Hardware for Walls over 4-1/2", Specify Wall Thickness, Price Per Inch</p>	LIST PRICE			TYPE NO.	17405		ADD FOR OPTIONS:			-10*.....	-7VP.....																																		
LIST PRICE																																																																					
TYPE NO.	17120																																																																				
ADD FOR OPTIONS:																																																																					
-10*.....	-77.....																																																																				
-67.....	-BB.....																																																																				
-75.....	-MMB.....																																																																				
-76.....																																																																					
LIST PRICE																																																																					
TYPE NO.	17405																																																																				
ADD FOR OPTIONS:																																																																					
-10*.....	-7VP.....																																																																				
 <p><b>17125</b></p>	<p><b>WALL-MOUNT, NON-ADJUSTABLE CONCEALED ARMS</b></p> <table border="1"> <tr><th colspan="3">LIST PRICE</th></tr> <tr> <td>TYPE NO.</td> <td>17125</td> <td></td> </tr> <tr> <td colspan="3">ADD FOR OPTIONS:</td> </tr> <tr> <td>-10*.....</td> <td>-75.....</td> <td></td> </tr> </table> <p>* Extension Sleeves Longer than 4", Specify Wall Thickness, Price Per Inch</p>	LIST PRICE			TYPE NO.	17125		ADD FOR OPTIONS:			-10*.....	-75.....		 <p><b>17550</b></p>	<p><b>FLOOR-MOUNT HANGER PLATE TYPE</b></p> <table border="1"> <tr><th colspan="4">LIST PRICE</th></tr> <tr> <td>17550</td> <td>17550-BB</td> <td>17550-UR 17550-WC</td> <td>17550-WCBL</td> </tr> <tr> <td colspan="4">ADD FOR OPTIONS:</td> </tr> <tr> <td>-10*</td> <td></td> <td></td> <td></td> </tr> <tr> <td>-60</td> <td></td> <td></td> <td></td> </tr> <tr> <td>-BB</td> <td></td> <td></td> <td></td> </tr> <tr> <td>-CL</td> <td></td> <td></td> <td></td> </tr> <tr> <td>-UR**</td> <td></td> <td></td> <td></td> </tr> <tr> <td>-WC**</td> <td></td> <td></td> <td></td> </tr> <tr> <td>-WCBL**</td> <td></td> <td></td> <td></td> </tr> </table> <p>* Hardware for Walls over 4", Specify Wall Thickness, Price Per Inch ** Cannot be Furnished with -60</p>	LIST PRICE				17550	17550-BB	17550-UR 17550-WC	17550-WCBL	ADD FOR OPTIONS:				-10*				-60				-BB				-CL				-UR**				-WC**				-WCBL**																	
LIST PRICE																																																																					
TYPE NO.	17125																																																																				
ADD FOR OPTIONS:																																																																					
-10*.....	-75.....																																																																				
LIST PRICE																																																																					
17550	17550-BB	17550-UR 17550-WC	17550-WCBL																																																																		
ADD FOR OPTIONS:																																																																					
-10*																																																																					
-60																																																																					
-BB																																																																					
-CL																																																																					
-UR**																																																																					
-WC**																																																																					
-WCBL**																																																																					
 <p><b>17125-UP-ADJ</b></p>	<p><b>PRE-ASSEMBLED CARRIER, FLOOR-MOUNT ADJUSTABLE CONCEALED ARMS</b></p> <table border="1"> <tr><th colspan="3">LIST PRICE</th></tr> <tr> <td>TYPE NO.</td> <td>17125-UP-ADJ</td> <td></td> </tr> <tr> <td colspan="3">ADD FOR OPTIONS:</td> </tr> <tr> <td>-10*.....</td> <td>-75.....</td> <td></td> </tr> </table> <p>* Extension Sleeves Longer than 4", Specify Wall Thickness, Price Per Inch</p>	LIST PRICE			TYPE NO.	17125-UP-ADJ		ADD FOR OPTIONS:			-10*.....	-75.....		<p><b>Fixture Carrier Option Descriptions</b></p> <table border="0"> <tr> <td>-BB Back-to-Back Carrier</td> <td>-60 Valve Plate for Attaching to Upright</td> </tr> <tr> <td>-BP with Back Plates</td> <td>-66 Split Header for Stainless Steel Arms</td> </tr> <tr> <td>-CL Corner Lavatory Carrier</td> <td>-67 Concealed Arm Carrier for Wheelchair Lavatory</td> </tr> <tr> <td>-HD Heavy-Duty</td> <td>-75 2" Chrome Plated Escutcheons</td> </tr> <tr> <td>-MMB with Movable Mounting Brackets</td> <td>-76 4" Chrome Plated Escutcheons</td> </tr> <tr> <td>-UR Urinal Carrier</td> <td>-77 6" Chrome Plated Escutcheons</td> </tr> <tr> <td>-VP Vandal-Proof Trim</td> <td>-58 Horizontal No-Hub Cast Long Barrel</td> </tr> <tr> <td>-WC Water Cooler Carrier</td> <td></td> </tr> <tr> <td>-WCBL Water Cooler Bi-Level Carrier</td> <td></td> </tr> <tr> <td>-10 Extension Sleeves or Hardware for Thicker Walls, See Product No-Hub Branch</td> <td></td> </tr> </table>		-BB Back-to-Back Carrier	-60 Valve Plate for Attaching to Upright	-BP with Back Plates	-66 Split Header for Stainless Steel Arms	-CL Corner Lavatory Carrier	-67 Concealed Arm Carrier for Wheelchair Lavatory	-HD Heavy-Duty	-75 2" Chrome Plated Escutcheons	-MMB with Movable Mounting Brackets	-76 4" Chrome Plated Escutcheons	-UR Urinal Carrier	-77 6" Chrome Plated Escutcheons	-VP Vandal-Proof Trim	-58 Horizontal No-Hub Cast Long Barrel	-WC Water Cooler Carrier		-WCBL Water Cooler Bi-Level Carrier		-10 Extension Sleeves or Hardware for Thicker Walls, See Product No-Hub Branch																																			
LIST PRICE																																																																					
TYPE NO.	17125-UP-ADJ																																																																				
ADD FOR OPTIONS:																																																																					
-10*.....	-75.....																																																																				
-BB Back-to-Back Carrier	-60 Valve Plate for Attaching to Upright																																																																				
-BP with Back Plates	-66 Split Header for Stainless Steel Arms																																																																				
-CL Corner Lavatory Carrier	-67 Concealed Arm Carrier for Wheelchair Lavatory																																																																				
-HD Heavy-Duty	-75 2" Chrome Plated Escutcheons																																																																				
-MMB with Movable Mounting Brackets	-76 4" Chrome Plated Escutcheons																																																																				
-UR Urinal Carrier	-77 6" Chrome Plated Escutcheons																																																																				
-VP Vandal-Proof Trim	-58 Horizontal No-Hub Cast Long Barrel																																																																				
-WC Water Cooler Carrier																																																																					
-WCBL Water Cooler Bi-Level Carrier																																																																					
-10 Extension Sleeves or Hardware for Thicker Walls, See Product No-Hub Branch																																																																					
 <p><b>17140</b></p>	<p><b>NON-ADJUSTABLE, CONCEALED ARMS w/WELDED SLEEVES FOR BLOCK WALL MOUNT</b></p> <table border="1"> <tr><th colspan="3">LIST PRICE</th></tr> <tr> <td>TYPE NO.</td> <td>17140</td> <td></td> </tr> <tr> <td colspan="3">ADD FOR OPTIONS:</td> </tr> <tr> <td>-75.....</td> <td></td> <td></td> </tr> </table>	LIST PRICE			TYPE NO.	17140		ADD FOR OPTIONS:			-75.....																																																										
LIST PRICE																																																																					
TYPE NO.	17140																																																																				
ADD FOR OPTIONS:																																																																					
-75.....																																																																					

**17560**



**FLOOR-MOUNT BEARING PLATE TYPE**

LIST PRICE			
17560	17560-BB	17560-UR 17560-WC	17560- WCBL

ADD FOR OPTIONS:

17560	17560-BB
-------	----------

-10\*  
-60  
-BB  
-UR\*\*  
-WC\*\*  
-WCBL\*\*

\* Hardware for Walls over 4", Specify Wall Thickness, Price Per Inch  
\*\* Cannot be Furnished with -60

**17590**

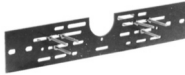

**WALL-MOUNT HANGER PLATE TYPE**

LIST PRICE		
17590	17590-DP	17590-UR

ADD FOR OPTIONS:

-10\* ..... -DP .....  
-UR .....

\* Hardware for Walls over 7" for 17590 or 4" for 17590-DP and 17590 -UR-DP, Specify Wall Thickness, Price Per Inch

**17720**



**FLOOR-MOUNT HEAVY-DUTY PLATE TYPE**

LIST PRICE	
TYPE NO.	17720

ADD FOR OPTIONS:

-10\* ..... -VP .....  
-66 .....

\* Hardware for Walls over 4", Specify Wall Thickness, Price Per Inch

**17730**



**FLOOR-MOUNT w/ADJUSTABLE COUPLING**

LIST PRICE	
TYPE NO.	17730

ADD FOR OPTIONS:

-11 ..... -VP .....  
-60 .....

**17735**

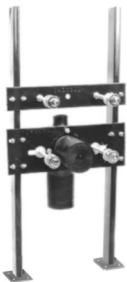

**FLOOR-MOUNT w/FITTING**

LIST PRICE	
TYPE NO.	17735

ADD FOR OPTIONS:

-10 ..... -60 .....  
-45 ..... -VP .....  
-46 .....

\* Hardware for Walls over 5-3/8", Specify Wall Thickness, Price Per Inch  
NOTE: Other Fittings Available on Request. Contact your Josam Representative.

### Fixture Carrier Option Descriptions

- BB Back-to-Back Carrier
- DP Double Plate Carrier
- UR Urinal Carrier
- VP Vandal-Proof Trim
- WC Water Cooler Carrier
- WCBL Water Cooler Bi-Level Carrier
- 10 Hardware for Thicker Walls
- 11 Cast Iron Adjustable Extension through 12" Length, Specify 6", 9" or 12" on Order
- 45 Threaded High Left-Hand Auxiliary Vent
- 46 Threaded High Right-Hand Auxiliary Vent
- 60 Valve Plate for Attaching to Upright
- 66 Split Header for Stainless Steel Arms

### ROOF DRAINS

**21500**



**15" DOME, LARGE SUMP**

PIPE SIZE	LIST PRICE			
	21500	21500-AE	21500-16	21500-AE-16
2", 3", 4"				
5", 6"				
8"				
10"				

ADD FOR OPTIONS:

-1 .....	-20 .....	-FG .....
-2 .....	-21-22 .....	-FG2 .....
-3 .....	-22 .....	-FG3 .....
-3C .....	-23 .....	-OR .....
-4 .....	-26 .....	-PFB .....
-6 .....	-33 .....	-T .....
-10* .....	-66 .....	-VP .....
-10-20* .....	-AE .....	-X .....
-16 φ .....	-AER .....	-Y .....
-17 (2") φ .....	-ARE .....	YGTC (2"-4") .....
-17 (4") φ .....	-IRMA .....	-Z .....
-19 .....	-CR .....	

\* Specify Height, Price Each 4" or Fraction  
φ -16 and -17 cannot be furnished together

### GREEN ROOF DRAINS

**21500-RDG**

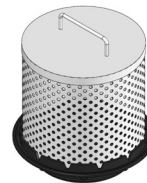

PIPE SIZE	LIST PRICE			
	21500-RDG1	21500-RDG2	21500-RDG3	21500-ORDG1
2", 3", 4"				
5", 6"				
8"				

ADD FOR OPTIONS:

-1 .....	-21 .....	-CR .....
-2 .....	-22 .....	-OR .....
-3 .....	-23 .....	-PC .....
-3C .....	-26 .....	-T .....
-4 .....	-33 .....	-VP .....
-6 .....	-66 .....	-X .....
-10* .....	-AE .....	-Y .....
-10-20* .....	-AER .....	-YGTC (2"-4") .....
-17 .....	-AI .....	-Z .....
-20 .....	-ARE .....	

\* Specify Height, Price Each 4" or Fraction

# ROOF DRAINS





A WATTS Brand

	<b>22010</b>			<b>12" BEEHIVE DOME, MEDIUM SUMP</b>		
	<b>LIST PRICE</b>					
	PIPE SIZE	2" - 6"				
	ADD FOR OPTIONS:					
-1.....	-19.....	-FG.....				
-2.....	-20.....	-IRMA†.....				
-3.....	-21.....	-T.....				
-3C.....	-23.....	-VP.....				
-10*.....	-26.....	-X.....				
-10-20*.....	-66.....	-Z.....				
-17 (2").....	-AER.....					
-17 (4").....	-ARE.....					
* Specify Height, Price Per Inch † Price up to 4". Each additional inch, add						

	<b>22080</b>			<b>9" HIGH DOME, SMALL SUMP</b>		
	<b>LIST PRICE</b>					
	PIPE SIZE	2", 3", 4"				
	ADD FOR OPTIONS:					
-1.....	-20.....	-IRMA†.....				
-2.....	-21.....	-PFB.....				
-3.....	-23.....	-T.....				
-3C.....	-26.....	-TSO ◊.....				
-10*.....	-33.....	-VP.....				
-10-20*.....	-66.....	-X.....				
-17 (2").....	-AER.....	-Y.....				
-17 (4").....	-ARE.....	-YGTC (2"-4").....				
-19.....	-FG.....	-Z.....				
* Specify Height, Price Per Inch † Price up to 4". Each additional inch, add ◊ Cannot be used with Drain Receiver						

	<b>22100</b>			<b>COMBINATION DRAIN/OVERFLOW, SMALL SUMP w/CI DOME</b>		
	<b>LIST PRICE</b>					
	PIPE SIZE	3", 4"				
	ADD FOR OPTIONS:					
-1.....	-23.....	-VP.....				
-10*.....	-33.....	-Z.....				
-20.....	-IRMA.....					
*Specify Height, Price Per Inch						

	<b>22200</b>			<b>COMBINATION DRAIN/OVERFLOW, MEDIUM SUMP w/CI DOME</b>		
	<b>LIST PRICE</b>					
	PIPE SIZE	2" - 6"				
	ADD FOR OPTIONS:					
-10*.....	-33.....	-T.....				
-10-20*.....	-66.....	-VP.....				
-20.....	-IRMA.....	-X.....				
-23.....	-RCSD.....	-Z.....				
*Specify Height, Price Per Inch						

	<b>22500</b>			<b>COMBINATION DRAIN/OVERFLOW, LARGE SUMP AND POLY DOME</b>		
	<b>LIST PRICE</b>					
	PIPE SIZE	2", 3", 4"	5", 6"	8"		
	ADD FOR OPTIONS:					
-1.....	-23.....	-RCSD.....				
-4.....	-26.....	-VP.....				
-10*.....	-33.....	-T.....				
-10-20.....	-66.....	-X.....				
-20.....	-AE.....	-Y.....				
-21-22.....	-AER.....	-YGTC (2"-4").....				
-22.....	-IRMA.....	-Z.....				
*Specify Height, Price Each 4" or Fraction.						











	<b>23500</b>			<b>14" PROMENADE TOP, LARGE SUMP</b>			
	<b>LIST PRICE</b>						
	PIPE SIZE	23500	23500-AE	23500-6	23500-IRMA		
	2", 3", 4" 5", 6" 8" 10"						
ADD FOR OPTIONS:							
-1.....	-20.....	-CR.....					
-2.....	-36.....	-IRMA.....					
-3.....	-37-50.....	-PG.....					
-3C.....	-37-51.....	-VP.....					
-4.....	-50.....	-T.....					
-6.....	-51.....	-X.....					
-10*.....	-66.....	-Y.....					
-10-20*.....	-AE.....	-YGTC (2"-4").....					
-18.....	-ARE.....	-Z.....					
* Specify Height, Price Each 4" or Fraction							

## Roof Drain Option Descriptions









- AE LEVELEZE® Adjustable Extension
- AER Adjustable Extension using Threaded Rods and Hardware
- ARE Acid-Resisting Epoxy
- CR Clamping Drain Receiver
- FG Flat Cast Iron Grate
- FG2 ADA/HP Flat Grate
- FG3 ADA/HP Flat Grate
- IRMA Perforated Stainless Steel Extension
- OR LEVELEZE® Adjustable Extension with O-Ring
- PC Perforated Cover
- PG PARKING GRATE
- RCSD Recessed Drain Receiver
- VP Vandal-Proof Dome or Grate
- 1 Deck Clamp Assembly
- 2 Drain Receiver
- 3 Deck Clamp Assembly and Drain Receiver
- 3C Drain Receiver and Drain Receiver Clips
- 4 Secondary Flashing Clamp (use with -AE Only)
- 6 Extra Wide Flange Drain Body (2" through 6", -X Only)
- 10 Fixed Extended Collar, Cast Iron
- 10-20 Fixed Extended Collar, Galvanized
- 16 Internal Water Guard 2-6" Outlets Only
- 17 2" High Solid Clamping Collar
- 18 Extra Deep Sump
- 19 Clamp Collar w/Perforated SS Gravel Guard
- 20 Galvanized Cast Iron Parts
- 21 Galvanized Cast Iron Dome Only
- 22 Cast Iron Dome
- 23 Rough Bronze Dome
- 26 Aluminum Dome
- 33 Stainless Mesh Screen-Covered Dome
- 36 Ductile Iron Grate (Cast Iron Top Only)
- 37-50 HD Ductile Iron Undergrate Laminated Top, Satin Finish Nikaloy
- 37-51 HD Ductile Iron Undergrate Laminated Top, Satin Finish Bronze
- 50 C.I. Undergrate Laminated Top, Satin Finish Nikaloy
- 51 C.I. Undergrate Laminated Top, Satin Finish Bronze







### Outlets

- 66 No-Hub Side Outlet, 2" - 6"
- T Threaded Outlet
- TSO Threaded Side Outlet
- X Inside Caulk Outlet
- Y Hub Outlet w/Gasket 2"-4"
- YGTC -Y Outlet Gasket with Test Cap
- Z No-Hub Spigot Outlet

<p><b>23510</b></p> 	<p><b>15" EXTRA HEAVY-DUTY PARKING GRATE, LARGE SUMP</b></p> <table border="1"> <thead> <tr> <th colspan="4">LIST PRICE</th> </tr> <tr> <th>PIPE SIZE</th> <th>2", 3", 4"</th> <th>5", 6"</th> <th>8"</th> </tr> </thead> <tbody> <tr> <td></td> <td></td> <td></td> <td></td> </tr> </tbody> </table> <p>ADD FOR OPTIONS:</p> <table border="0"> <tr> <td>-1.....</td> <td>-20.....</td> <td>-T.....</td> </tr> <tr> <td>-2.....</td> <td>-36.....</td> <td>-VP.....</td> </tr> <tr> <td>-3.....</td> <td>-50.....</td> <td>-X.....</td> </tr> <tr> <td>-3C.....</td> <td>-51.....</td> <td>-Y.....</td> </tr> <tr> <td>-10*.....</td> <td>-66.....</td> <td>-YGTC (2"-4").....</td> </tr> <tr> <td>-10-20*.....</td> <td>-CR.....</td> <td>-Z.....</td> </tr> </table> <p>* Specify Height, Price Each 4" or Fraction</p>	LIST PRICE				PIPE SIZE	2", 3", 4"	5", 6"	8"					-1.....	-20.....	-T.....	-2.....	-36.....	-VP.....	-3.....	-50.....	-X.....	-3C.....	-51.....	-Y.....	-10*.....	-66.....	-YGTC (2"-4").....	-10-20*.....	-CR.....	-Z.....	<p><b>24030</b></p> 	<p><b>13" SUPER-FLO® TOP, MEDIUM SUMP COMPOSITION DECK FLANGE</b></p> <table border="1"> <thead> <tr> <th colspan="3">LIST PRICE</th> </tr> <tr> <th>PIPE SIZE</th> <th>4", 5", 6", 8"</th> <th></th> </tr> </thead> <tbody> <tr> <td></td> <td></td> <td></td> </tr> </tbody> </table> <p>ADD FOR OPTIONS:</p> <table border="0"> <tr> <td>-1.....</td> <td>\$408.00</td> <td>-31.....</td> <td>-66.....</td> </tr> <tr> <td>-20.....</td> <td>1,451.00</td> <td>-36.....</td> <td>-HP.....</td> </tr> <tr> <td>-29.....</td> <td>439.00</td> <td>-50.....</td> <td>-VP.....</td> </tr> <tr> <td>-29-20.....</td> <td>800.00</td> <td>-51.....</td> <td>-X.....</td> </tr> </table>	LIST PRICE			PIPE SIZE	4", 5", 6", 8"					-1.....	\$408.00	-31.....	-66.....	-20.....	1,451.00	-36.....	-HP.....	-29.....	439.00	-50.....	-VP.....	-29-20.....	800.00	-51.....	-X.....
LIST PRICE																																																										
PIPE SIZE	2", 3", 4"	5", 6"	8"																																																							
-1.....	-20.....	-T.....																																																								
-2.....	-36.....	-VP.....																																																								
-3.....	-50.....	-X.....																																																								
-3C.....	-51.....	-Y.....																																																								
-10*.....	-66.....	-YGTC (2"-4").....																																																								
-10-20*.....	-CR.....	-Z.....																																																								
LIST PRICE																																																										
PIPE SIZE	4", 5", 6", 8"																																																									
-1.....	\$408.00	-31.....	-66.....																																																							
-20.....	1,451.00	-36.....	-HP.....																																																							
-29.....	439.00	-50.....	-VP.....																																																							
-29-20.....	800.00	-51.....	-X.....																																																							
<p><b>23710</b></p> 	<p><b>11" PROMENADE TOP, MEDIUM SUMP</b></p> <table border="1"> <thead> <tr> <th colspan="2">LIST PRICE</th> </tr> <tr> <th>PIPE SIZE</th> <th>2" - 6"</th> </tr> </thead> <tbody> <tr> <td></td> <td></td> </tr> </tbody> </table> <p>ADD FOR OPTIONS:</p> <table border="0"> <tr> <td>-1.....</td> <td>-20.....</td> <td>-T.....</td> </tr> <tr> <td>-2.....</td> <td>-50.....</td> <td>-VP.....</td> </tr> <tr> <td>-3.....</td> <td>-51.....</td> <td>-X.....</td> </tr> <tr> <td>-3C.....</td> <td>-66.....</td> <td>-Z.....</td> </tr> <tr> <td>-12*.....</td> <td>-IRMA†.....</td> <td></td> </tr> </table> <p>* Specify Height, Price Per Inch † Price up to 4". Each additional inch, add</p>	LIST PRICE		PIPE SIZE	2" - 6"			-1.....	-20.....	-T.....	-2.....	-50.....	-VP.....	-3.....	-51.....	-X.....	-3C.....	-66.....	-Z.....	-12*.....	-IRMA†.....		<p><b>24040</b></p> 	<p><b>9" SUPER-FLO® TOP, MEDIUM SUMP COMPOSITION DECK FLANGE</b></p> <table border="1"> <thead> <tr> <th colspan="3">LIST PRICE</th> </tr> <tr> <th>PIPE SIZE</th> <th>2", 3", 4"</th> <th></th> </tr> </thead> <tbody> <tr> <td></td> <td></td> <td></td> </tr> </tbody> </table> <p>ADD FOR OPTIONS:</p> <table border="0"> <tr> <td>-1.....</td> <td>-36.....</td> <td>-HP.....</td> </tr> <tr> <td>-20.....</td> <td>-38.....</td> <td>-VP.....</td> </tr> <tr> <td>-29.....</td> <td>-50.....</td> <td>-X.....</td> </tr> <tr> <td>-29-20.....</td> <td>-51.....</td> <td></td> </tr> <tr> <td>-31.....</td> <td>-66.....</td> <td></td> </tr> </table>	LIST PRICE			PIPE SIZE	2", 3", 4"					-1.....	-36.....	-HP.....	-20.....	-38.....	-VP.....	-29.....	-50.....	-X.....	-29-20.....	-51.....		-31.....	-66.....											
LIST PRICE																																																										
PIPE SIZE	2" - 6"																																																									
-1.....	-20.....	-T.....																																																								
-2.....	-50.....	-VP.....																																																								
-3.....	-51.....	-X.....																																																								
-3C.....	-66.....	-Z.....																																																								
-12*.....	-IRMA†.....																																																									
LIST PRICE																																																										
PIPE SIZE	2", 3", 4"																																																									
-1.....	-36.....	-HP.....																																																								
-20.....	-38.....	-VP.....																																																								
-29.....	-50.....	-X.....																																																								
-29-20.....	-51.....																																																									
-31.....	-66.....																																																									
<p><b>23730</b></p> 	<p><b>9" PROMENADE TOP, SMALL SUMP</b></p> <table border="1"> <thead> <tr> <th colspan="2">LIST PRICE</th> </tr> <tr> <th>PIPE SIZE</th> <th>2", 3", 4"</th> </tr> </thead> <tbody> <tr> <td></td> <td></td> </tr> </tbody> </table> <p>ADD FOR OPTIONS:</p> <table border="0"> <tr> <td>-1.....</td> <td>-20.....</td> <td>-TSO ◊.....</td> </tr> <tr> <td>-2.....</td> <td>-50.....</td> <td>-VP.....</td> </tr> <tr> <td>-3.....</td> <td>-51.....</td> <td>-X.....</td> </tr> <tr> <td>-3C.....</td> <td>-66.....</td> <td>-Y.....</td> </tr> <tr> <td>-12*.....</td> <td>-IRMA†.....</td> <td>-YGTC (2"-4").....</td> </tr> <tr> <td>-12-20*.....</td> <td>-T.....</td> <td>-Z.....</td> </tr> </table> <p>* Specify Height, Price Per Inch † Price up to 4". Each additional inch, add ◊ Cannot be used with Drain Receiver</p>	LIST PRICE		PIPE SIZE	2", 3", 4"			-1.....	-20.....	-TSO ◊.....	-2.....	-50.....	-VP.....	-3.....	-51.....	-X.....	-3C.....	-66.....	-Y.....	-12*.....	-IRMA†.....	-YGTC (2"-4").....	-12-20*.....	-T.....	-Z.....	<p><b>24050</b></p> 	<p><b>GARAGE DRAIN, 13" SPECIAL-DUTY TOP, WIDE FLANGE</b></p> <table border="1"> <thead> <tr> <th colspan="3">LIST PRICE</th> </tr> <tr> <th>PIPE SIZE</th> <th>4" - 6"</th> <th>8"</th> </tr> </thead> <tbody> <tr> <td></td> <td></td> <td></td> </tr> </tbody> </table> <p>ADD FOR OPTIONS:</p> <table border="0"> <tr> <td>-1.....</td> <td>-29-20.....</td> <td>-51.....</td> </tr> <tr> <td>-12*.....</td> <td>-31.....</td> <td>-66.....</td> </tr> <tr> <td>-20.....</td> <td>-36.....</td> <td>-HP.....</td> </tr> <tr> <td>-29.....</td> <td>-50.....</td> <td>-VP.....</td> </tr> <tr> <td></td> <td></td> <td>-X.....</td> </tr> </table> <p>* Specify Height, Price Per Inch</p>	LIST PRICE			PIPE SIZE	4" - 6"	8"				-1.....	-29-20.....	-51.....	-12*.....	-31.....	-66.....	-20.....	-36.....	-HP.....	-29.....	-50.....	-VP.....			-X.....							
LIST PRICE																																																										
PIPE SIZE	2", 3", 4"																																																									
-1.....	-20.....	-TSO ◊.....																																																								
-2.....	-50.....	-VP.....																																																								
-3.....	-51.....	-X.....																																																								
-3C.....	-66.....	-Y.....																																																								
-12*.....	-IRMA†.....	-YGTC (2"-4").....																																																								
-12-20*.....	-T.....	-Z.....																																																								
LIST PRICE																																																										
PIPE SIZE	4" - 6"	8"																																																								
-1.....	-29-20.....	-51.....																																																								
-12*.....	-31.....	-66.....																																																								
-20.....	-36.....	-HP.....																																																								
-29.....	-50.....	-VP.....																																																								
		-X.....																																																								
<p><b>23740</b></p> 	<p><b>8" HEAVY-DUTY TOP, MEDIUM SUMP</b></p> <table border="1"> <thead> <tr> <th colspan="2">LIST PRICE</th> </tr> <tr> <th>PIPE SIZE</th> <th>2", 3", 4"</th> </tr> </thead> <tbody> <tr> <td></td> <td></td> </tr> </tbody> </table> <p>ADD FOR OPTIONS:</p> <table border="0"> <tr> <td>-1.....</td> <td>-20.....</td> <td>-VP.....</td> </tr> <tr> <td>-2.....</td> <td>-51Ded.....</td> <td>-X.....</td> </tr> <tr> <td>-3.....</td> <td>-66.....</td> <td>-Y.....</td> </tr> <tr> <td>-3C.....</td> <td>-IRMA†.....</td> <td>-YGTC (2"-4").....</td> </tr> <tr> <td>-12*.....</td> <td>-TSO ◊.....</td> <td>-Z.....</td> </tr> <tr> <td>-12-20*.....</td> <td>-T.....</td> <td></td> </tr> </table> <p>* Specify Height, Price Per Inch † Price up to 4". Each additional inch, add ◊ Cannot be used with Drain Receiver</p>	LIST PRICE		PIPE SIZE	2", 3", 4"			-1.....	-20.....	-VP.....	-2.....	-51Ded.....	-X.....	-3.....	-66.....	-Y.....	-3C.....	-IRMA†.....	-YGTC (2"-4").....	-12*.....	-TSO ◊.....	-Z.....	-12-20*.....	-T.....		<p><b>24060</b></p> 	<p><b>15" SPECIAL-DUTY TOP COMPOSITION DECK FLANGE</b></p> <table border="1"> <thead> <tr> <th colspan="3">LIST PRICE</th> </tr> <tr> <th>PIPE SIZE</th> <th>4" - 6"</th> <th>8"</th> </tr> </thead> <tbody> <tr> <td></td> <td></td> <td></td> </tr> </tbody> </table> <p>ADD FOR OPTIONS:</p> <table border="0"> <tr> <td>-1.....</td> <td>-29-20.....</td> <td>-51.....</td> </tr> <tr> <td>-20.....</td> <td>-31.....</td> <td>-66.....</td> </tr> <tr> <td>-29.....</td> <td>-50.....</td> <td>-VP.....</td> </tr> <tr> <td></td> <td></td> <td>-X.....</td> </tr> </table> <p>* Specify Height, Price Per Inch</p>	LIST PRICE			PIPE SIZE	4" - 6"	8"				-1.....	-29-20.....	-51.....	-20.....	-31.....	-66.....	-29.....	-50.....	-VP.....			-X.....										
LIST PRICE																																																										
PIPE SIZE	2", 3", 4"																																																									
-1.....	-20.....	-VP.....																																																								
-2.....	-51Ded.....	-X.....																																																								
-3.....	-66.....	-Y.....																																																								
-3C.....	-IRMA†.....	-YGTC (2"-4").....																																																								
-12*.....	-TSO ◊.....	-Z.....																																																								
-12-20*.....	-T.....																																																									
LIST PRICE																																																										
PIPE SIZE	4" - 6"	8"																																																								
-1.....	-29-20.....	-51.....																																																								
-20.....	-31.....	-66.....																																																								
-29.....	-50.....	-VP.....																																																								
		-X.....																																																								
<p><b>24020</b></p> 	<p><b>9" SUPER-FLO® TOP, MEDIUM SUMP COMPOSITION DECK FLANGE</b></p> <table border="1"> <thead> <tr> <th colspan="2">LIST PRICE</th> </tr> <tr> <th>PIPE SIZE</th> <th>2", 3", 4"</th> </tr> </thead> <tbody> <tr> <td></td> <td></td> </tr> </tbody> </table> <p>ADD FOR OPTIONS:</p> <table border="0"> <tr> <td>-1.....</td> <td>-36.....</td> <td>-HP.....</td> </tr> <tr> <td>-20.....</td> <td>-38.....</td> <td>-VP.....</td> </tr> <tr> <td>-29.....</td> <td>-50.....</td> <td>-X.....</td> </tr> <tr> <td>-29-20.....</td> <td>-51.....</td> <td></td> </tr> <tr> <td>-31.....</td> <td>-66.....</td> <td></td> </tr> </table>	LIST PRICE		PIPE SIZE	2", 3", 4"			-1.....	-36.....	-HP.....	-20.....	-38.....	-VP.....	-29.....	-50.....	-X.....	-29-20.....	-51.....		-31.....	-66.....		<p><b>24200</b></p> 	<p><b>16" PROMENADE TOP, ALL LEVEL BONDING FLANGE</b></p> <table border="1"> <thead> <tr> <th colspan="3">LIST PRICE</th> </tr> <tr> <th>PIPE SIZE</th> <th>2" - 6"</th> <th></th> </tr> </thead> <tbody> <tr> <td></td> <td></td> <td></td> </tr> </tbody> </table> <p>ADD FOR OPTIONS:</p> <table border="0"> <tr> <td>-1.....</td> <td>-51.....</td> <td>-X.....</td> </tr> <tr> <td>-20.....</td> <td>-66.....</td> <td></td> </tr> <tr> <td>-50.....</td> <td>-VP.....</td> <td></td> </tr> </table>	LIST PRICE			PIPE SIZE	2" - 6"					-1.....	-51.....	-X.....	-20.....	-66.....		-50.....	-VP.....																	
LIST PRICE																																																										
PIPE SIZE	2", 3", 4"																																																									
-1.....	-36.....	-HP.....																																																								
-20.....	-38.....	-VP.....																																																								
-29.....	-50.....	-X.....																																																								
-29-20.....	-51.....																																																									
-31.....	-66.....																																																									
LIST PRICE																																																										
PIPE SIZE	2" - 6"																																																									
-1.....	-51.....	-X.....																																																								
-20.....	-66.....																																																									
-50.....	-VP.....																																																									
		<p><b>24500</b></p> 	<p><b>SILL TYPE 4" DOME, SHALLOW SUMP</b></p> <table border="1"> <thead> <tr> <th colspan="4">LIST PRICE</th> </tr> <tr> <th>PIPE SIZE</th> <th>24500</th> <th>24500-45</th> <th>24500-90</th> </tr> </thead> <tbody> <tr> <td>2", 3", 4"</td> <td></td> <td></td> <td></td> </tr> </tbody> </table> <p>ADD FOR OPTIONS:</p> <table border="0"> <tr> <td>-20.....</td> <td>-35.....</td> <td>-90.....</td> </tr> <tr> <td>-24.....</td> <td>-45.....</td> <td>-T.....</td> </tr> <tr> <td>-27.....</td> <td>-50.....</td> <td>-VP.....</td> </tr> <tr> <td>-33.....</td> <td>-51.....</td> <td></td> </tr> </table>	LIST PRICE				PIPE SIZE	24500	24500-45	24500-90	2", 3", 4"				-20.....	-35.....	-90.....	-24.....	-45.....	-T.....	-27.....	-50.....	-VP.....	-33.....	-51.....																																
LIST PRICE																																																										
PIPE SIZE	24500	24500-45	24500-90																																																							
2", 3", 4"																																																										
-20.....	-35.....	-90.....																																																								
-24.....	-45.....	-T.....																																																								
-27.....	-50.....	-VP.....																																																								
-33.....	-51.....																																																									

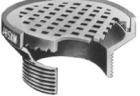







	<b>24700 PARAPET TYPE, SLOPING GRATE</b>																																																	
	<table border="1"> <thead> <tr> <th colspan="4">LIST PRICE</th> </tr> <tr> <th>PIPE SIZE</th> <th>2", 3", 4"</th> <th colspan="2">5", 6"</th> </tr> </thead> <tbody> <tr> <td colspan="4">ADD FOR OPTIONS:</td> </tr> <tr> <td>-20 (2" - 4")</td> <td>-51</td> <td colspan="2"></td> </tr> <tr> <td>-20 (5" - 6")</td> <td>-61 (2" - 4")</td> <td colspan="2"></td> </tr> <tr> <td>-22</td> <td>-61 (5" - 6")</td> <td colspan="2"></td> </tr> <tr> <td>-24</td> <td>-61-20 (2" - 4")</td> <td colspan="2"></td> </tr> <tr> <td>-45</td> <td>-61-20 (5" - 6")</td> <td colspan="2"></td> </tr> <tr> <td>-50</td> <td></td> <td colspan="2"></td> </tr> </tbody> </table>				LIST PRICE				PIPE SIZE	2", 3", 4"	5", 6"		ADD FOR OPTIONS:				-20 (2" - 4")	-51			-20 (5" - 6")	-61 (2" - 4")			-22	-61 (5" - 6")			-24	-61-20 (2" - 4")			-45	-61-20 (5" - 6")			-50													
LIST PRICE																																																		
PIPE SIZE	2", 3", 4"	5", 6"																																																
ADD FOR OPTIONS:																																																		
-20 (2" - 4")	-51																																																	
-20 (5" - 6")	-61 (2" - 4")																																																	
-22	-61 (5" - 6")																																																	
-24	-61-20 (2" - 4")																																																	
-45	-61-20 (5" - 6")																																																	
-50																																																		
	<b>24720 PARAPET TYPE, ANGLE GRATE</b>																																																	
	<table border="1"> <thead> <tr> <th colspan="4">LIST PRICE</th> </tr> <tr> <th>PIPE SIZE</th> <th>24720</th> <th colspan="2">24720-45</th> </tr> <tr> <th>2", 3", 4" 5", 6"</th> <td></td> <td colspan="2"></td> </tr> </thead> <tbody> <tr> <td colspan="4">ADD FOR OPTIONS:</td> </tr> <tr> <td>-20 (2" - 4")</td> <td>-50</td> <td colspan="2"></td> </tr> <tr> <td>-20 (5" - 6")</td> <td>-51</td> <td colspan="2"></td> </tr> <tr> <td>-23 (2" - 4")</td> <td>-61 (2" - 4")</td> <td colspan="2"></td> </tr> <tr> <td>-23 (5" - 6")</td> <td>-61 (5" - 6")</td> <td colspan="2"></td> </tr> <tr> <td>-24 (2" - 4")</td> <td>-61-20 (2" - 4")</td> <td colspan="2"></td> </tr> <tr> <td>-24 (5" - 6")</td> <td>-61-20 (5" - 6")</td> <td colspan="2"></td> </tr> <tr> <td>-45</td> <td>-VP</td> <td colspan="2"></td> </tr> </tbody> </table>				LIST PRICE				PIPE SIZE	24720	24720-45		2", 3", 4" 5", 6"				ADD FOR OPTIONS:				-20 (2" - 4")	-50			-20 (5" - 6")	-51			-23 (2" - 4")	-61 (2" - 4")			-23 (5" - 6")	-61 (5" - 6")			-24 (2" - 4")	-61-20 (2" - 4")			-24 (5" - 6")	-61-20 (5" - 6")			-45	-VP				
LIST PRICE																																																		
PIPE SIZE	24720	24720-45																																																
2", 3", 4" 5", 6"																																																		
ADD FOR OPTIONS:																																																		
-20 (2" - 4")	-50																																																	
-20 (5" - 6")	-51																																																	
-23 (2" - 4")	-61 (2" - 4")																																																	
-23 (5" - 6")	-61 (5" - 6")																																																	
-24 (2" - 4")	-61-20 (2" - 4")																																																	
-24 (5" - 6")	-61-20 (5" - 6")																																																	
-45	-VP																																																	
	<b>24900 PARAPET TYPE, ANGLE DOME GRATE</b>																																																	
	<table border="1"> <thead> <tr> <th colspan="4">LIST PRICE</th> </tr> <tr> <th>PIPE SIZE</th> <th colspan="3">2" - 6"</th> </tr> </thead> <tbody> <tr> <td colspan="4">ADD FOR OPTIONS:</td> </tr> <tr> <td>-20</td> <td>-61 (5" - 6")</td> <td colspan="2"></td> </tr> <tr> <td>-24</td> <td>-61-20 (2" - 4")</td> <td colspan="2"></td> </tr> <tr> <td>-50</td> <td>-61-20 (5" - 6")</td> <td colspan="2"></td> </tr> <tr> <td>-51</td> <td>-VP</td> <td colspan="2"></td> </tr> <tr> <td>-61 (2" - 4")</td> <td></td> <td colspan="2"></td> </tr> </tbody> </table>				LIST PRICE				PIPE SIZE	2" - 6"			ADD FOR OPTIONS:				-20	-61 (5" - 6")			-24	-61-20 (2" - 4")			-50	-61-20 (5" - 6")			-51	-VP			-61 (2" - 4")																	
LIST PRICE																																																		
PIPE SIZE	2" - 6"																																																	
ADD FOR OPTIONS:																																																		
-20	-61 (5" - 6")																																																	
-24	-61-20 (2" - 4")																																																	
-50	-61-20 (5" - 6")																																																	
-51	-VP																																																	
-61 (2" - 4")																																																		
	<b>25000 PARAPET SCUPPER SLEEVE</b>																																																	
	<table border="1"> <thead> <tr> <th colspan="5">LIST PRICE</th> </tr> <tr> <th>Wall Thickness</th> <th>9"</th> <th>13"</th> <th>17"</th> <th>21"</th> </tr> </thead> <tbody> <tr> <td colspan="5">ADD FOR OPTIONS:</td> </tr> <tr> <td>-20</td> <td colspan="4"></td> </tr> </tbody> </table>				LIST PRICE					Wall Thickness	9"	13"	17"	21"	ADD FOR OPTIONS:					-20																														
LIST PRICE																																																		
Wall Thickness	9"	13"	17"	21"																																														
ADD FOR OPTIONS:																																																		
-20																																																		
	<b>25010 DOWNSPOUT NOZZLE</b>																																																	
	<table border="1"> <thead> <tr> <th colspan="5">LIST PRICE</th> </tr> <tr> <th>PIPE SIZE</th> <th>2", 3", 4"</th> <th>5", 6"</th> <th>8"</th> <th>10"</th> <th>*12"</th> </tr> </thead> <tbody> <tr> <td colspan="6">ADD FOR OPTIONS:</td> </tr> <tr> <td>-24 (2" - 6")</td> <td>-51 (10")</td> <td colspan="4"></td> </tr> <tr> <td>-24 (8")</td> <td>-BS</td> <td colspan="4"></td> </tr> <tr> <td>-24 (10")</td> <td>-PVC</td> <td colspan="4"></td> </tr> <tr> <td>-51 (2" - 6")</td> <td>-T</td> <td colspan="4"></td> </tr> <tr> <td>-51 (8")</td> <td>-Z**</td> <td colspan="4"></td> </tr> </tbody> </table> <p>* 12" Size No-Hub Only ** Bronze Only</p>				LIST PRICE					PIPE SIZE	2", 3", 4"	5", 6"	8"	10"	*12"	ADD FOR OPTIONS:						-24 (2" - 6")	-51 (10")					-24 (8")	-BS					-24 (10")	-PVC					-51 (2" - 6")	-T					-51 (8")	-Z**			
LIST PRICE																																																		
PIPE SIZE	2", 3", 4"	5", 6"	8"	10"	*12"																																													
ADD FOR OPTIONS:																																																		
-24 (2" - 6")	-51 (10")																																																	
-24 (8")	-BS																																																	
-24 (10")	-PVC																																																	
-51 (2" - 6")	-T																																																	
-51 (8")	-Z**																																																	
	<b>25020 SPECIAL PURPOSE DOWNSPOUT COVER</b>																																																	
	<table border="1"> <thead> <tr> <th colspan="4">LIST PRICE</th> </tr> <tr> <th>PIPE SIZE</th> <th>2", 3", 4"</th> <th>5", 6"</th> <th>8"</th> </tr> <tr> <th>PIPE SIZE</th> <th>10"</th> <th>12"</th> <th>15"</th> </tr> </thead> <tbody> <tr> <td colspan="4">ADD FOR OPTIONS:</td> </tr> <tr> <td>-316</td> <td>-VP</td> <td colspan="2"></td> </tr> <tr> <td>-SLT</td> <td>-Z (4" - 15")</td> <td colspan="2"></td> </tr> </tbody> </table>				LIST PRICE				PIPE SIZE	2", 3", 4"	5", 6"	8"	PIPE SIZE	10"	12"	15"	ADD FOR OPTIONS:				-316	-VP			-SLT	-Z (4" - 15")																								
LIST PRICE																																																		
PIPE SIZE	2", 3", 4"	5", 6"	8"																																															
PIPE SIZE	10"	12"	15"																																															
ADD FOR OPTIONS:																																																		
-316	-VP																																																	
-SLT	-Z (4" - 15")																																																	
	<b>25030 DOWNSPOUT BOOT, GALVANIZED</b>																																																	
	<table border="1"> <thead> <tr> <th colspan="3">LIST PRICE</th> </tr> <tr> <th></th> <th>4x3</th> <th>25033</th> </tr> <tr> <th></th> <th>5x4</th> <th>25034</th> </tr> <tr> <th></th> <th>5x3</th> <th>25035</th> </tr> </thead> <tbody> </tbody> </table>				LIST PRICE				4x3	25033		5x4	25034		5x3	25035																																		
LIST PRICE																																																		
	4x3	25033																																																
	5x4	25034																																																
	5x3	25035																																																
	<b>25500 FLOSEPTOR®, LARGE SUMP</b>																																																	
	<table border="1"> <thead> <tr> <th colspan="3">LIST PRICE</th> </tr> <tr> <th>PIPE SIZE</th> <th>2", 3", 4"</th> <th>5", 6"</th> </tr> </thead> <tbody> <tr> <td colspan="3">ADD FOR OPTIONS:</td> </tr> <tr> <td>-AE</td> <td>-2</td> <td>-X</td> </tr> <tr> <td>-AER</td> <td>-3</td> <td>-Y</td> </tr> <tr> <td>-CR</td> <td>-10*</td> <td>-YGTC (2" - 4")</td> </tr> <tr> <td>-FG</td> <td>-20</td> <td>-Z</td> </tr> <tr> <td>-OR</td> <td>-66</td> <td></td> </tr> <tr> <td>-1</td> <td>T</td> <td></td> </tr> </tbody> </table> <p>*Specify Height, Price Each 4" or Fraction</p>				LIST PRICE			PIPE SIZE	2", 3", 4"	5", 6"	ADD FOR OPTIONS:			-AE	-2	-X	-AER	-3	-Y	-CR	-10*	-YGTC (2" - 4")	-FG	-20	-Z	-OR	-66		-1	T																				
LIST PRICE																																																		
PIPE SIZE	2", 3", 4"	5", 6"																																																
ADD FOR OPTIONS:																																																		
-AE	-2	-X																																																
-AER	-3	-Y																																																
-CR	-10*	-YGTC (2" - 4")																																																
-FG	-20	-Z																																																
-OR	-66																																																	
-1	T																																																	
<b>Option Descriptions</b>																																																		
<ul style="list-style-type: none"> <li>-AE LEVELEZE® Adjustable Extension</li> <li>-AER Adjustable Extension with Rods</li> <li>-BS Bird Screen</li> <li>-CR Clamping Drain Receiver</li> <li>-FG Flat Grate (Replaces Dome Strainer)</li> <li>-HP Heel-Proof Grate</li> <li>-IRMA Perforated Stainless Steel Extension</li> <li>-OR Adjustable Extension with O-Ring</li> <li>-SLT Slotted Cover (1/4")</li> <li>-VP Vandal-Proof Dome</li> <li>-1 Deck Clamp Assembly</li> <li>-2 Drain Receiver</li> <li>-3 Deck Clamp Assembly and Drain Receiver</li> <li>-3C Drain Receiver and Drain Receiver Clips</li> <li>-10 Fixed Extension Collar, Cast Iron</li> <li>-10-20 Fixed Extension Collar, Galvanized</li> <li>-12 Extended Flashing Collar, Cast Iron</li> <li>-12-20 Extended Flashing Collar, Galvanized</li> <li>-20 Galvanized Cast Iron Parts</li> <li>-22 Cast Iron Grate</li> <li>-23 Rough Bronze Grate</li> <li>-24 Rough Nikaloy Dome or Grate</li> <li>-27 High Dome</li> <li>-29 Sediment Bucket, Cast Iron</li> <li>-29-20 Sediment Bucket, Galvanized</li> <li>-31 Chain Anchored Grate</li> <li>-33 Stainless Mesh Screen-Covered Dome</li> <li>-35 Flat Grate</li> <li>-36 Ductile Iron Grate (Cast Iron Top Only)</li> <li>-38 Less Grate</li> <li>-50 C.I. Undergrate Laminated Top, Satin Finish Nikaloy</li> <li>-51 C.I. Undergrate Laminated Top, Satin Finish Bronze</li> <li>-61 Downspout Elbow, Cast Iron</li> <li>-61-20 Downspout Elbow, Galvanized</li> <li>-316 Type 316L Stainless Steel</li> </ul> <b>Outlets</b> <ul style="list-style-type: none"> <li>-45 Body with 45 Degree Threaded Outlet</li> <li>-66 No-Hub Side Outlet, 2" - 6"</li> <li>-90 Body with 90 Degree Threaded Outlet</li> <li>-PVC Metal Nozzle to fit PVC Pipe</li> <li>-T Threaded Outlet</li> <li>-TSO Threaded Side Outlet</li> <li>-X Inside Caulk Outlet</li> <li>-Y Hub Outlet with Gasket 2" - 4"</li> <li>-YGTC -Y Outlet Gasket with Test Cap</li> <li>-Z No-Hub Spigot Outlet</li> </ul>																																																		

<p><b>25520</b></p> 	<p><b>FLO-SEPTOR®, MEDIUM SUMP</b></p> <table border="1"> <thead> <tr> <th colspan="3">LIST PRICE</th> </tr> <tr> <th>PIPE SIZE</th> <th colspan="2">2" - 6"</th> </tr> </thead> <tbody> <tr> <td colspan="3">ADD FOR OPTIONS:</td> </tr> <tr> <td>-1.....</td> <td>-10*.....</td> <td>-T.....</td> </tr> <tr> <td>-2.....</td> <td>-20.....</td> <td>-X.....</td> </tr> <tr> <td>-3.....</td> <td>-66.....</td> <td>-Z.....</td> </tr> </tbody> </table> <p>* Price per inch</p>	LIST PRICE			PIPE SIZE	2" - 6"		ADD FOR OPTIONS:			-1.....	-10*.....	-T.....	-2.....	-20.....	-X.....	-3.....	-66.....	-Z.....	<p><b>28600</b></p> 	<p><b>FLO-SET®, 15" DOME, LARGE SUMP</b></p> <table border="1"> <thead> <tr> <th colspan="3">LIST PRICE</th> </tr> <tr> <th>PIPE SIZE</th> <th>28600</th> <th>28600-AE</th> </tr> </thead> <tbody> <tr> <td>2", 3", 4" 5", 6"</td> <td></td> <td></td> </tr> <tr> <td colspan="3">ADD FOR OPTIONS:</td> </tr> <tr> <td>-1.....</td> <td>10-20*.....</td> <td>-T.....</td> </tr> <tr> <td>-2.....</td> <td>-20.....</td> <td>-VP.....</td> </tr> <tr> <td>-3.....</td> <td>-23.....</td> <td>-X.....</td> </tr> <tr> <td>-3C.....</td> <td>-66.....</td> <td>-Y.....</td> </tr> <tr> <td>-4.....</td> <td>-AE.....</td> <td>-YGTC (2"-4").....</td> </tr> <tr> <td>-10*.....</td> <td>-CR.....</td> <td>-Z.....</td> </tr> </tbody> </table> <p>* Specify Height, Price Each 4" or Fraction</p>	LIST PRICE			PIPE SIZE	28600	28600-AE	2", 3", 4" 5", 6"			ADD FOR OPTIONS:			-1.....	10-20*.....	-T.....	-2.....	-20.....	-VP.....	-3.....	-23.....	-X.....	-3C.....	-66.....	-Y.....	-4.....	-AE.....	-YGTC (2"-4").....	-10*.....	-CR.....	-Z.....					
LIST PRICE																																																								
PIPE SIZE	2" - 6"																																																							
ADD FOR OPTIONS:																																																								
-1.....	-10*.....	-T.....																																																						
-2.....	-20.....	-X.....																																																						
-3.....	-66.....	-Z.....																																																						
LIST PRICE																																																								
PIPE SIZE	28600	28600-AE																																																						
2", 3", 4" 5", 6"																																																								
ADD FOR OPTIONS:																																																								
-1.....	10-20*.....	-T.....																																																						
-2.....	-20.....	-VP.....																																																						
-3.....	-23.....	-X.....																																																						
-3C.....	-66.....	-Y.....																																																						
-4.....	-AE.....	-YGTC (2"-4").....																																																						
-10*.....	-CR.....	-Z.....																																																						
<p><b>25540</b></p> 	<p><b>FLO-SEPTOR®, SMALL SUMP</b></p> <table border="1"> <thead> <tr> <th colspan="3">LIST PRICE</th> </tr> <tr> <th>PIPE SIZE</th> <th colspan="2">2", 3", 4"</th> </tr> </thead> <tbody> <tr> <td colspan="3">ADD FOR OPTIONS:</td> </tr> <tr> <td>-1.....</td> <td>-66.....</td> <td>-Y.....</td> </tr> <tr> <td>-2.....</td> <td>-T.....</td> <td>-YGTC (2"-4").....</td> </tr> <tr> <td>-3.....</td> <td>-TSO*.....</td> <td>-Z.....</td> </tr> <tr> <td>-20.....</td> <td>-X.....</td> <td></td> </tr> </tbody> </table> <p>* Cannot be used with Drain Receiver</p>	LIST PRICE			PIPE SIZE	2", 3", 4"		ADD FOR OPTIONS:			-1.....	-66.....	-Y.....	-2.....	-T.....	-YGTC (2"-4").....	-3.....	-TSO*.....	-Z.....	-20.....	-X.....		<p><b>29000</b></p> 	<p><b>ISOLATION DECK DRAIN</b></p> <table border="1"> <thead> <tr> <th colspan="4">LIST PRICE</th> </tr> <tr> <th>PIPE SIZE</th> <th>2", 3", 4"</th> <th>5", 6"</th> <th>8"</th> </tr> </thead> <tbody> <tr> <td colspan="4">ADD FOR OPTIONS:</td> </tr> <tr> <td>-1.....</td> <td>-20.....</td> <td>-X.....</td> <td></td> </tr> <tr> <td>-2.....</td> <td>-66.....</td> <td>-Y.....</td> <td></td> </tr> <tr> <td>-3.....</td> <td>-CR.....</td> <td>-YGTC (2"-4").....</td> <td></td> </tr> <tr> <td>-3C.....</td> <td>-T.....</td> <td>-Z.....</td> <td></td> </tr> <tr> <td>-17.....</td> <td>-WH.....</td> <td></td> <td></td> </tr> </tbody> </table>	LIST PRICE				PIPE SIZE	2", 3", 4"	5", 6"	8"	ADD FOR OPTIONS:				-1.....	-20.....	-X.....		-2.....	-66.....	-Y.....		-3.....	-CR.....	-YGTC (2"-4").....		-3C.....	-T.....	-Z.....		-17.....	-WH.....		
LIST PRICE																																																								
PIPE SIZE	2", 3", 4"																																																							
ADD FOR OPTIONS:																																																								
-1.....	-66.....	-Y.....																																																						
-2.....	-T.....	-YGTC (2"-4").....																																																						
-3.....	-TSO*.....	-Z.....																																																						
-20.....	-X.....																																																							
LIST PRICE																																																								
PIPE SIZE	2", 3", 4"	5", 6"	8"																																																					
ADD FOR OPTIONS:																																																								
-1.....	-20.....	-X.....																																																						
-2.....	-66.....	-Y.....																																																						
-3.....	-CR.....	-YGTC (2"-4").....																																																						
-3C.....	-T.....	-Z.....																																																						
-17.....	-WH.....																																																							
<p><b>26200</b></p> 	<p><b>EXPANSION JOINT</b></p> <table border="1"> <thead> <tr> <th colspan="5">LIST PRICE</th> </tr> <tr> <th>PIPE SIZE</th> <th>2"</th> <th>3"</th> <th>4"</th> <th>5"</th> </tr> </thead> <tbody> <tr> <td>PIPE SIZE</td> <td>6"</td> <td>8"</td> <td>10"</td> <td></td> </tr> <tr> <td colspan="5">ADD FOR OPTIONS:</td> </tr> <tr> <td colspan="5">-BR (2" - 8")..... -20.....</td> </tr> </tbody> </table>	LIST PRICE					PIPE SIZE	2"	3"	4"	5"	PIPE SIZE	6"	8"	10"		ADD FOR OPTIONS:					-BR (2" - 8")..... -20.....					<p><b>29100</b></p> 	<p><b>16" DOME, EXTRA LARGE SUMP</b></p> <table border="1"> <thead> <tr> <th colspan="4">LIST PRICE</th> </tr> <tr> <th>PIPE SIZE</th> <th>8"</th> <th>10"</th> <th>12"</th> </tr> </thead> <tbody> <tr> <td colspan="4">ADD FOR OPTIONS:</td> </tr> <tr> <td>-1.....</td> <td>-10-20*.....</td> <td>-AER.....</td> <td></td> </tr> <tr> <td>-2.....</td> <td>-17.....</td> <td>-VP.....</td> <td></td> </tr> <tr> <td>-3.....</td> <td>-174.....</td> <td>-Z.....</td> <td></td> </tr> <tr> <td>-10*.....</td> <td>-20.....</td> <td></td> <td></td> </tr> </tbody> </table> <p>* Specify Height, Price Each 4" or Fraction</p>	LIST PRICE				PIPE SIZE	8"	10"	12"	ADD FOR OPTIONS:				-1.....	-10-20*.....	-AER.....		-2.....	-17.....	-VP.....		-3.....	-174.....	-Z.....		-10*.....	-20.....		
LIST PRICE																																																								
PIPE SIZE	2"	3"	4"	5"																																																				
PIPE SIZE	6"	8"	10"																																																					
ADD FOR OPTIONS:																																																								
-BR (2" - 8")..... -20.....																																																								
LIST PRICE																																																								
PIPE SIZE	8"	10"	12"																																																					
ADD FOR OPTIONS:																																																								
-1.....	-10-20*.....	-AER.....																																																						
-2.....	-17.....	-VP.....																																																						
-3.....	-174.....	-Z.....																																																						
-10*.....	-20.....																																																							
<p><b>26440</b></p> 	<p><b>STACK FLASHING FITTING</b></p> <table border="1"> <thead> <tr> <th colspan="4">LIST PRICE</th> </tr> <tr> <th>PIPE SIZE</th> <th>1 1/2"</th> <th>2"</th> <th>3"</th> </tr> </thead> <tbody> <tr> <td>PIPE SIZE</td> <td>4"</td> <td>5"</td> <td>6"</td> </tr> <tr> <td colspan="4">ADD FOR OPTIONS:</td> </tr> <tr> <td colspan="4">-20.....</td> </tr> </tbody> </table>	LIST PRICE				PIPE SIZE	1 1/2"	2"	3"	PIPE SIZE	4"	5"	6"	ADD FOR OPTIONS:				-20.....				<p><b>Roof Drain Option Descriptions</b></p> <ul style="list-style-type: none"> <li>-AE LEVELEZE® Adjustable Extension</li> <li>-AER Adjustable Extension using Threaded Rod Hardware</li> <li>-BR Bronze Sleeve, 2" - 8"</li> <li>-CR Clamping Drain Receiver</li> <li>-VP Vandal-Proof Dome</li> <li>-WH Weeping Holes</li> <li>-1 Deck Clamp Assembly</li> <li>-2 Drain Receiver</li> <li>-3 Deck Clamp Assembly and Drain Receiver</li> <li>-3C Drain Receiver and Drain Receiver Clips</li> <li>-4 Secondary Flashing Clamp (use with -AE Only)</li> <li>-10 Fixed Extension Collar, Cast Iron</li> <li>-10-20 Fixed Extension Collar, Galvanized</li> <li>-17 2" High Solid Clamping Collar</li> <li>-174 4" High Solid Clamping Collar</li> <li>-20 Galvanized Cast Iron Parts</li> <li>-23 Rough Bronze Dome</li> <li>-33 Stainless Steel Mesh-Covered</li> <li>-63 All Rough Bronze</li> <li>-65 All Rough Nikaloy</li> <li>Outlets</li> <li>-66 No-Hub Side Outlet, 2" - 6"</li> <li>-T Threaded Outlet</li> <li>-TSO Threaded Side Outlet</li> <li>-X Inside Caulk Outlet</li> <li>-Y Hub Outlet with Gasket 2"-4"</li> <li>-YGTC -Y Outlet Gasket with Test Cap</li> <li>-Z No-Hub Spigot Outlet</li> </ul>																																		
LIST PRICE																																																								
PIPE SIZE	1 1/2"	2"	3"																																																					
PIPE SIZE	4"	5"	6"																																																					
ADD FOR OPTIONS:																																																								
-20.....																																																								
<p><b>26450</b></p> 	<p><b>VENT STACK FLASHING SLEEVE</b></p> <table border="1"> <thead> <tr> <th colspan="4">LIST PRICE</th> </tr> <tr> <th>PIPE SIZE</th> <th>1 1/2"</th> <th>2"</th> <th>3"</th> </tr> </thead> <tbody> <tr> <td>PIPE SIZE</td> <td>4"</td> <td>5"</td> <td>6"</td> </tr> <tr> <td colspan="4">ADD FOR OPTIONS:</td> </tr> <tr> <td colspan="4">-20.....</td> </tr> </tbody> </table>	LIST PRICE				PIPE SIZE	1 1/2"	2"	3"	PIPE SIZE	4"	5"	6"	ADD FOR OPTIONS:				-20.....																																						
LIST PRICE																																																								
PIPE SIZE	1 1/2"	2"	3"																																																					
PIPE SIZE	4"	5"	6"																																																					
ADD FOR OPTIONS:																																																								
-20.....																																																								
<p><b>26700</b></p> 	<p><b>VANDAL-PROOF VENT CAP</b></p> <table border="1"> <thead> <tr> <th colspan="5">LIST PRICE</th> </tr> <tr> <th>PIPE SIZE</th> <th>1 1/2"</th> <th>2"</th> <th>2 1/2"</th> <th>3"</th> </tr> </thead> <tbody> <tr> <td>PIPE SIZE</td> <td>4"</td> <td>5"</td> <td>6"</td> <td></td> </tr> <tr> <td colspan="5">ADD FOR OPTIONS:</td> </tr> <tr> <td colspan="5">-20..... -63.....</td> </tr> <tr> <td colspan="5">-33..... -65.....</td> </tr> </tbody> </table>	LIST PRICE					PIPE SIZE	1 1/2"	2"	2 1/2"	3"	PIPE SIZE	4"	5"	6"		ADD FOR OPTIONS:					-20..... -63.....					-33..... -65.....																													
LIST PRICE																																																								
PIPE SIZE	1 1/2"	2"	2 1/2"	3"																																																				
PIPE SIZE	4"	5"	6"																																																					
ADD FOR OPTIONS:																																																								
-20..... -63.....																																																								
-33..... -65.....																																																								

 <p><b>A</b></p>	<p><b>ROUND NIKALOY SUPER-FLO® STRAINER</b></p> <table border="1"> <thead> <tr> <th colspan="5">LIST PRICE</th> </tr> <tr> <th>Strainer</th> <th>Strainer Only</th> <th>With 30000†</th> <th>With 30304</th> <th>With 30000-ST</th> </tr> </thead> <tbody> <tr> <td>5A</td> <td></td> <td></td> <td></td> <td></td> </tr> <tr> <td>6A</td> <td></td> <td></td> <td></td> <td></td> </tr> <tr> <td>7A</td> <td></td> <td></td> <td></td> <td></td> </tr> <tr> <td>8A</td> <td></td> <td></td> <td></td> <td></td> </tr> <tr> <td>9A*</td> <td></td> <td></td> <td></td> <td></td> </tr> <tr> <td>10A*</td> <td></td> <td></td> <td></td> <td></td> </tr> </tbody> </table> <p>ADD FOR OPTIONS:</p> <table border="1"> <tr> <td>-2 (5A).....</td> <td>-HD (5", 6").....</td> </tr> <tr> <td>-2 (6A).....</td> <td>-J.....</td> </tr> <tr> <td>-2 (7A).....</td> <td>-SS (5A - 6A).....</td> </tr> <tr> <td>-2 (8A).....</td> <td>-SS (7A-8A).....</td> </tr> <tr> <td>-2 (9A,10A)*.....</td> <td>-SS-LR (6A).....</td> </tr> <tr> <td>-80.....</td> <td>-SS-LR-MFP (6A).....</td> </tr> <tr> <td>-5A-CP.....</td> <td>-TSI.....</td> </tr> <tr> <td>-6A-CP.....</td> <td>-VP.....</td> </tr> <tr> <td>-DBC (5", 6").....</td> <td>-YGTC (2"-4").....</td> </tr> <tr> <td>-DBC (8").....</td> <td>* Not SUPER-FLO® Design</td> </tr> </table> <p>†For 6" pipe size add</p>	LIST PRICE					Strainer	Strainer Only	With 30000†	With 30304	With 30000-ST	5A					6A					7A					8A					9A*					10A*					-2 (5A).....	-HD (5", 6").....	-2 (6A).....	-J.....	-2 (7A).....	-SS (5A - 6A).....	-2 (8A).....	-SS (7A-8A).....	-2 (9A,10A)*.....	-SS-LR (6A).....	-80.....	-SS-LR-MFP (6A).....	-5A-CP.....	-TSI.....	-6A-CP.....	-VP.....	-DBC (5", 6").....	-YGTC (2"-4").....	-DBC (8").....	* Not SUPER-FLO® Design	 <p><b>D</b></p>	<p><b>ROUND NIKALOY DOME STRAINER</b></p> <table border="1"> <thead> <tr> <th colspan="5">LIST PRICE</th> </tr> <tr> <th>Strainer</th> <th>Strainer Only</th> <th>With 30000†</th> <th>With 30304</th> <th>With 30000-ST</th> </tr> </thead> <tbody> <tr> <td>5D</td> <td></td> <td></td> <td></td> <td></td> </tr> <tr> <td>6D</td> <td></td> <td></td> <td></td> <td></td> </tr> </tbody> </table> <p>ADD FOR OPTIONS:</p> <table border="1"> <tr> <td>-2 (5D).....</td> <td>-TSI.....</td> </tr> <tr> <td>-2 (6D).....</td> <td>-VP.....</td> </tr> <tr> <td>-80.....</td> <td>-YGTC (2"-4").....</td> </tr> <tr> <td>-J.....</td> <td></td> </tr> </table> <p>†For 6" pipe size add</p>	LIST PRICE					Strainer	Strainer Only	With 30000†	With 30304	With 30000-ST	5D					6D					-2 (5D).....	-TSI.....	-2 (6D).....	-VP.....	-80.....	-YGTC (2"-4").....	-J.....	
LIST PRICE																																																																																											
Strainer	Strainer Only	With 30000†	With 30304	With 30000-ST																																																																																							
5A																																																																																											
6A																																																																																											
7A																																																																																											
8A																																																																																											
9A*																																																																																											
10A*																																																																																											
-2 (5A).....	-HD (5", 6").....																																																																																										
-2 (6A).....	-J.....																																																																																										
-2 (7A).....	-SS (5A - 6A).....																																																																																										
-2 (8A).....	-SS (7A-8A).....																																																																																										
-2 (9A,10A)*.....	-SS-LR (6A).....																																																																																										
-80.....	-SS-LR-MFP (6A).....																																																																																										
-5A-CP.....	-TSI.....																																																																																										
-6A-CP.....	-VP.....																																																																																										
-DBC (5", 6").....	-YGTC (2"-4").....																																																																																										
-DBC (8").....	* Not SUPER-FLO® Design																																																																																										
LIST PRICE																																																																																											
Strainer	Strainer Only	With 30000†	With 30304	With 30000-ST																																																																																							
5D																																																																																											
6D																																																																																											
-2 (5D).....	-TSI.....																																																																																										
-2 (6D).....	-VP.....																																																																																										
-80.....	-YGTC (2"-4").....																																																																																										
-J.....																																																																																											
 <p><b>6AD</b></p>	<p><b>ROUND NIKALOY STRAINER w/CLAMP DEVICE</b></p> <table border="1"> <thead> <tr> <th colspan="5">LIST PRICE</th> </tr> <tr> <th>Strainer</th> <th>Strainer Only</th> <th>With 30000†</th> <th>With 30304</th> <th>With 30000-ST</th> </tr> </thead> <tbody> <tr> <td>6AD</td> <td></td> <td></td> <td></td> <td></td> </tr> </tbody> </table> <p>ADD FOR OPTIONS:</p> <table border="1"> <tr> <td>-2.....</td> <td>-TSI.....</td> </tr> <tr> <td>-80.....</td> <td>-VP.....</td> </tr> <tr> <td>-J.....</td> <td>-YGTC (2"-4").....</td> </tr> </table> <p>†For 6" pipe size add</p>	LIST PRICE					Strainer	Strainer Only	With 30000†	With 30304	With 30000-ST	6AD					-2.....	-TSI.....	-80.....	-VP.....	-J.....	-YGTC (2"-4").....	 <p><b>E</b></p>	<p><b>ROUND NIKALOY TRACTOR STRAINER</b></p> <table border="1"> <thead> <tr> <th colspan="5">LIST PRICE</th> </tr> <tr> <th>Strainer</th> <th>Strainer Only</th> <th>With 30000†</th> <th>With 30304</th> <th>With 30000-ST</th> </tr> </thead> <tbody> <tr> <td>6E</td> <td></td> <td></td> <td></td> <td></td> </tr> <tr> <td>7E</td> <td></td> <td></td> <td></td> <td></td> </tr> <tr> <td>9E</td> <td></td> <td></td> <td></td> <td></td> </tr> </tbody> </table> <p>ADD FOR OPTIONS:</p> <table border="1"> <tr> <td>-2 (6E).....</td> <td>-SS (6E).....</td> </tr> <tr> <td>-2 (7E).....</td> <td>-SS (7E).....</td> </tr> <tr> <td>-2 (9E).....</td> <td>-TSI.....</td> </tr> <tr> <td>-80.....</td> <td>-VP.....</td> </tr> <tr> <td>-93 (7E).....</td> <td>-YGTC (2"-4").....</td> </tr> <tr> <td>-J.....</td> <td></td> </tr> </table> <p>†For 6" pipe size add</p>	LIST PRICE					Strainer	Strainer Only	With 30000†	With 30304	With 30000-ST	6E					7E					9E					-2 (6E).....	-SS (6E).....	-2 (7E).....	-SS (7E).....	-2 (9E).....	-TSI.....	-80.....	-VP.....	-93 (7E).....	-YGTC (2"-4").....	-J.....																															
LIST PRICE																																																																																											
Strainer	Strainer Only	With 30000†	With 30304	With 30000-ST																																																																																							
6AD																																																																																											
-2.....	-TSI.....																																																																																										
-80.....	-VP.....																																																																																										
-J.....	-YGTC (2"-4").....																																																																																										
LIST PRICE																																																																																											
Strainer	Strainer Only	With 30000†	With 30304	With 30000-ST																																																																																							
6E																																																																																											
7E																																																																																											
9E																																																																																											
-2 (6E).....	-SS (6E).....																																																																																										
-2 (7E).....	-SS (7E).....																																																																																										
-2 (9E).....	-TSI.....																																																																																										
-80.....	-VP.....																																																																																										
-93 (7E).....	-YGTC (2"-4").....																																																																																										
-J.....																																																																																											
 <p><b>AF</b></p>	<p><b>ROUND NIKALOY STRAINER w/TILE FLANGE</b></p> <table border="1"> <thead> <tr> <th colspan="5">LIST PRICE</th> </tr> <tr> <th>Strainer</th> <th>Strainer Only</th> <th>With 30000†</th> <th>With 30304</th> <th>With 30000-ST</th> </tr> </thead> <tbody> <tr> <td>6AF</td> <td></td> <td></td> <td></td> <td></td> </tr> </tbody> </table> <p>ADD FOR OPTIONS:</p> <table border="1"> <tr> <td>-2.....</td> <td>-TSI.....</td> </tr> <tr> <td>-80.....</td> <td>-VP.....</td> </tr> <tr> <td>-J.....</td> <td>-YGTC (2"-4").....</td> </tr> </table> <p>†For 6" pipe size add</p>	LIST PRICE					Strainer	Strainer Only	With 30000†	With 30304	With 30000-ST	6AF					-2.....	-TSI.....	-80.....	-VP.....	-J.....	-YGTC (2"-4").....	 <p><b>E1</b></p>	<p><b>ROUND NIKALOY TRACTOR STRAINER w/EXTENDER RIM</b></p> <table border="1"> <thead> <tr> <th colspan="5">LIST PRICE</th> </tr> <tr> <th>Strainer</th> <th>Strainer Only</th> <th>With 30000†</th> <th>With 30304</th> <th>With 30000-ST</th> </tr> </thead> <tbody> <tr> <td>6E1</td> <td></td> <td></td> <td></td> <td></td> </tr> <tr> <td>7E1</td> <td></td> <td></td> <td></td> <td></td> </tr> <tr> <td>9E1</td> <td></td> <td></td> <td></td> <td></td> </tr> </tbody> </table> <p>ADD FOR OPTIONS:</p> <table border="1"> <tr> <td>-2 (6E1).....</td> <td>-J.....</td> </tr> <tr> <td>-2 (7E1).....</td> <td>-TSI.....</td> </tr> <tr> <td>-2 (9E1).....</td> <td>-VP.....</td> </tr> <tr> <td>-80.....</td> <td>-YGTC (2"-4").....</td> </tr> </table> <p>†For 6" pipe size add</p>	LIST PRICE					Strainer	Strainer Only	With 30000†	With 30304	With 30000-ST	6E1					7E1					9E1					-2 (6E1).....	-J.....	-2 (7E1).....	-TSI.....	-2 (9E1).....	-VP.....	-80.....	-YGTC (2"-4").....																																		
LIST PRICE																																																																																											
Strainer	Strainer Only	With 30000†	With 30304	With 30000-ST																																																																																							
6AF																																																																																											
-2.....	-TSI.....																																																																																										
-80.....	-VP.....																																																																																										
-J.....	-YGTC (2"-4").....																																																																																										
LIST PRICE																																																																																											
Strainer	Strainer Only	With 30000†	With 30304	With 30000-ST																																																																																							
6E1																																																																																											
7E1																																																																																											
9E1																																																																																											
-2 (6E1).....	-J.....																																																																																										
-2 (7E1).....	-TSI.....																																																																																										
-2 (9E1).....	-VP.....																																																																																										
-80.....	-YGTC (2"-4").....																																																																																										
 <p><b>5C</b></p>	<p><b>ROUND NIKALOY NON-CLOG STRAINER w/INTEGRAL BUCKET</b></p> <table border="1"> <thead> <tr> <th colspan="5">LIST PRICE</th> </tr> <tr> <th>Strainer</th> <th>Strainer Only</th> <th>With 30000†</th> <th>With 30304</th> <th>With 30000-ST</th> </tr> </thead> <tbody> <tr> <td>5C</td> <td></td> <td></td> <td></td> <td></td> </tr> </tbody> </table> <p>ADD FOR OPTIONS:</p> <table border="1"> <tr> <td>-2.....</td> <td>-VP.....</td> </tr> <tr> <td>-TSI.....</td> <td>-YGTC (2"-4").....</td> </tr> </table> <p>†For 6" pipe size add</p>	LIST PRICE					Strainer	Strainer Only	With 30000†	With 30304	With 30000-ST	5C					-2.....	-VP.....	-TSI.....	-YGTC (2"-4").....	 <p><b>E2</b></p>	<p><b>ROUND NIKALOY STRAINER w/ROUND FUNNEL</b></p> <table border="1"> <thead> <tr> <th colspan="5">LIST PRICE</th> </tr> <tr> <th>Strainer</th> <th>Strainer Only</th> <th>With 30000†</th> <th>With 30304</th> <th>With 30000-ST</th> </tr> </thead> <tbody> <tr> <td>7E2</td> <td></td> <td></td> <td></td> <td></td> </tr> </tbody> </table> <p>ADD FOR OPTIONS:</p> <table border="1"> <tr> <td>-2.....</td> <td>-TSI.....</td> </tr> <tr> <td>-80.....</td> <td>-VP.....</td> </tr> <tr> <td>-J.....</td> <td>-YGTC (2"-4").....</td> </tr> </table> <p>†For 6" pipe size add</p>	LIST PRICE					Strainer	Strainer Only	With 30000†	With 30304	With 30000-ST	7E2					-2.....	-TSI.....	-80.....	-VP.....	-J.....	-YGTC (2"-4").....																																																
LIST PRICE																																																																																											
Strainer	Strainer Only	With 30000†	With 30304	With 30000-ST																																																																																							
5C																																																																																											
-2.....	-VP.....																																																																																										
-TSI.....	-YGTC (2"-4").....																																																																																										
LIST PRICE																																																																																											
Strainer	Strainer Only	With 30000†	With 30304	With 30000-ST																																																																																							
7E2																																																																																											
-2.....	-TSI.....																																																																																										
-80.....	-VP.....																																																																																										
-J.....	-YGTC (2"-4").....																																																																																										

### Strainer Option Descriptions

-CP	Chrome Plated	-TSI	Trap Seal Insert
-DBC	Debris Cover	-VP	Secured Grate, Vandal-Proof Screws
-HD	Heavy-Duty Heel Proof (Nikaloy Only)	-YGTC	-Y Outlet Gasket with Test Cap
-J	Backwater Valve	-2	Satin Finish Bronze
-SS	Stainless Steel	-63	Spanner Wrench
-SS-LR	SS Ligature Resistant	-80	Perforated Stainless Steel Basket
-SS-LR-MFP	SS Ligature Resistant, Mirror Polish Finish	-93	Cast Iron Strainer

<p><b>E3</b></p> 	<p><b>ROUND NIKALOY STRAINER w/OVAL FUNNEL</b></p> <table border="1"> <thead> <tr> <th colspan="5">LIST PRICE</th> </tr> <tr> <th>Strainer</th> <th>Strainer Only</th> <th>With 30000†</th> <th>With 30304</th> <th>With 30000-ST</th> </tr> </thead> <tbody> <tr> <td>7E3</td> <td></td> <td></td> <td></td> <td></td> </tr> </tbody> </table> <p>ADD FOR OPTIONS:</p> <p>-2 ..... -TSI .....</p> <p>-80 ..... -VP .....</p> <p>-J ..... -YGTC (2"-4") .....</p> <p>†For 6" pipe size add</p>	LIST PRICE					Strainer	Strainer Only	With 30000†	With 30304	With 30000-ST	7E3					<p><b>G</b></p> 	<p><b>ROUND NIKALOY STRAINER w/SOLID HINGED COVER</b></p> <table border="1"> <thead> <tr> <th colspan="5">LIST PRICE</th> </tr> <tr> <th>Strainer</th> <th>Strainer Only</th> <th>With 30000†</th> <th>With 30304</th> <th>With 30000-ST</th> </tr> </thead> <tbody> <tr> <td>5G</td> <td></td> <td></td> <td></td> <td></td> </tr> <tr> <td>6G</td> <td></td> <td></td> <td></td> <td></td> </tr> <tr> <td>7G</td> <td></td> <td></td> <td></td> <td></td> </tr> <tr> <td>8G</td> <td></td> <td></td> <td></td> <td></td> </tr> </tbody> </table> <p>ADD FOR OPTIONS:</p> <p>-2 (5G) ..... -J .....</p> <p>-2 (6G) ..... -TSI .....</p> <p>-2 (7G) ..... -VP .....</p> <p>-2 (8G) ..... -YGTC (2"-4") .....</p> <p>†For 6" pipe size add</p>	LIST PRICE					Strainer	Strainer Only	With 30000†	With 30304	With 30000-ST	5G					6G					7G					8G				
LIST PRICE																																																
Strainer	Strainer Only	With 30000†	With 30304	With 30000-ST																																												
7E3																																																
LIST PRICE																																																
Strainer	Strainer Only	With 30000†	With 30304	With 30000-ST																																												
5G																																																
6G																																																
7G																																																
8G																																																
<p><b>F</b></p> 	<p><b>ROUND NIKALOY STRAINER w/SOLID THREADED COVER</b></p> <table border="1"> <thead> <tr> <th colspan="5">LIST PRICE</th> </tr> <tr> <th>Strainer</th> <th>Strainer Only</th> <th>With 30000†</th> <th>With 30304</th> <th>With 30000-ST</th> </tr> </thead> <tbody> <tr> <td>6F</td> <td></td> <td></td> <td></td> <td></td> </tr> </tbody> </table> <p>ADD FOR OPTIONS:</p> <p>-2 ..... -J .....</p> <p>-63 ..... -TSI .....</p> <p>-80 ..... -YGTC (2"-4") .....</p> <p>†For 6" pipe size add</p>	LIST PRICE					Strainer	Strainer Only	With 30000†	With 30304	With 30000-ST	6F					<p><b>H</b></p> 	<p><b>ROUND NIKALOY STRAINER w/HINGED GRATE</b></p> <table border="1"> <thead> <tr> <th colspan="5">LIST PRICE</th> </tr> <tr> <th>Strainer</th> <th>Strainer Only</th> <th>With 30000†</th> <th>With 30304</th> <th>With 30000-ST</th> </tr> </thead> <tbody> <tr> <td>5H</td> <td></td> <td></td> <td></td> <td></td> </tr> <tr> <td>6H</td> <td></td> <td></td> <td></td> <td></td> </tr> <tr> <td>7H</td> <td></td> <td></td> <td></td> <td></td> </tr> <tr> <td>8H</td> <td></td> <td></td> <td></td> <td></td> </tr> </tbody> </table> <p>ADD FOR OPTIONS:</p> <p>-2 (5H) ..... -J .....</p> <p>-2 (6H) ..... -TSI .....</p> <p>-2 (7H) ..... -VP .....</p> <p>-2 (8H) ..... -YGTC (2"-4") .....</p> <p>-80 (6H - 8H) .....</p> <p>†For 6" pipe size add</p>	LIST PRICE					Strainer	Strainer Only	With 30000†	With 30304	With 30000-ST	5H					6H					7H					8H				
LIST PRICE																																																
Strainer	Strainer Only	With 30000†	With 30304	With 30000-ST																																												
6F																																																
LIST PRICE																																																
Strainer	Strainer Only	With 30000†	With 30304	With 30000-ST																																												
5H																																																
6H																																																
7H																																																
8H																																																
<p><b>F4, F6</b></p> 	<p><b>ROUND NIKALOY FUNNEL ASSEMBLIES</b></p> <table border="1"> <thead> <tr> <th colspan="2">LIST PRICE</th> </tr> <tr> <th>Funnel</th> <th></th> </tr> </thead> <tbody> <tr> <td>F4</td> <td></td> </tr> <tr> <td>F6</td> <td></td> </tr> </tbody> </table> <p>ADD FOR OPTIONS:</p> <p>-2 ..... -93 (F4) .....</p> <p>-92 (F4) ..... -93 (F6) .....</p> <p>-92 (F6) ..... -ARE .....</p>	LIST PRICE		Funnel		F4		F6		<p><b>M</b></p> 	<p><b>ROUND CHROME PLATED OVERFLOW STANDPIPE w/DOME</b></p> <table border="1"> <thead> <tr> <th colspan="5">LIST PRICE</th> </tr> <tr> <th>Strainer</th> <th>Strainer Only</th> <th>With 30000†</th> <th>With 30304</th> <th>With 30000-ST</th> </tr> </thead> <tbody> <tr> <td>2M</td> <td></td> <td></td> <td></td> <td></td> </tr> <tr> <td>3M</td> <td></td> <td></td> <td></td> <td></td> </tr> </tbody> </table> <p>ADD FOR OPTIONS:</p> <p>-2 (2M) ..... -24 (3M) .....</p> <p>-2 (3M) ..... -PF .....</p> <p>-24 (2M) ..... -YGTC (2"-4") .....</p> <p>†For 6" pipe size add</p> <p>For Each Inch Over 6" Standard CP -2</p> <p>Add for 2M</p> <p>Add for 3M</p>	LIST PRICE					Strainer	Strainer Only	With 30000†	With 30304	With 30000-ST	2M					3M																					
LIST PRICE																																																
Funnel																																																
F4																																																
F6																																																
LIST PRICE																																																
Strainer	Strainer Only	With 30000†	With 30304	With 30000-ST																																												
2M																																																
3M																																																
<p><b>F8, F9</b></p> 	<p><b>OVAL NIKALOY FUNNEL ASSEMBLIES</b></p> <table border="1"> <thead> <tr> <th colspan="2">LIST PRICE</th> </tr> <tr> <th>Funnel</th> <th></th> </tr> </thead> <tbody> <tr> <td>F8</td> <td></td> </tr> <tr> <td>F9</td> <td></td> </tr> </tbody> </table> <p>ADD FOR OPTIONS:</p> <p>-2 ..... -93 (F8) .....</p> <p>-92 (F8) ..... -93 (F9) .....</p> <p>-92 (F9) ..... -ARE .....</p>	LIST PRICE		Funnel		F8		F9		<p><b>P</b></p> 	<p><b>ANGLE NIKALOY STRAINER</b></p> <table border="1"> <thead> <tr> <th colspan="5">LIST PRICE</th> </tr> <tr> <th>Strainer</th> <th>Strainer Only</th> <th>With 30000†</th> <th>With 30304</th> <th>With 30000-ST</th> </tr> </thead> <tbody> <tr> <td>4P</td> <td></td> <td></td> <td></td> <td></td> </tr> <tr> <td>6P</td> <td></td> <td></td> <td></td> <td></td> </tr> </tbody> </table> <p>ADD FOR OPTIONS:</p> <p>-2 (4P) ..... -TSI .....</p> <p>-2 (6P) ..... -VP .....</p> <p>-80 ..... -YGTC (2"-4") .....</p> <p>†For 6" pipe size add</p>	LIST PRICE					Strainer	Strainer Only	With 30000†	With 30304	With 30000-ST	4P					6P																					
LIST PRICE																																																
Funnel																																																
F8																																																
F9																																																
LIST PRICE																																																
Strainer	Strainer Only	With 30000†	With 30304	With 30000-ST																																												
4P																																																
6P																																																
<p><b>F52, F53</b></p> 	<p><b>ROUND CAST IRON FUNNEL ASSEMBLIES</b></p> <table border="1"> <thead> <tr> <th colspan="2">LIST PRICE</th> </tr> <tr> <th>Funnel</th> <th></th> </tr> </thead> <tbody> <tr> <td>F52</td> <td></td> </tr> <tr> <td>F53</td> <td></td> </tr> </tbody> </table> <p>ADD FOR OPTIONS:</p> <p>-1 ..... -92 .....</p>	LIST PRICE		Funnel		F52		F53																																								
LIST PRICE																																																
Funnel																																																
F52																																																
F53																																																

# Strainers & Bodies • FLOOR DRAINS



A WATTS Brand

<b>R</b> 	<b>RECTANGULAR NIKALOY STRAINER</b>				
	<b>LIST PRICE</b>				
	Strainer	Strainer Only	With 30000†	With 30304	With 30000-ST
	5R 6R 7R 8R				
	<b>ADD FOR OPTIONS:</b>				

<b>S</b> 	<b>SQUARE NIKALOY SUPER-FLO® STRAINER</b>				
	<b>LIST PRICE</b>				
	Strainer	Strainer Only	With 30000†	With 30304	With 30000-ST
	5S 6S 8S 9S				
	<b>ADD FOR OPTIONS:</b>				

<b>T</b> 	<b>SQUARE NIKALOY STRAINER w/HINGED GRATE</b>				
	<b>LIST PRICE</b>				
	Strainer	Strainer Only	With 30000†	With 30304	With 30000-ST
	5T 6T 9T				
	<b>ADD FOR OPTIONS:</b>				

<b>W</b> 	<b>CAST IRON STRAINER EXTENSION</b>				
	<b>LIST PRICE</b>				
	Strainer	Strainer Only	With 30000†	With 30304	With 30000-ST
	2W 4W 6W				
	<b>ADD FOR OPTIONS:</b>				

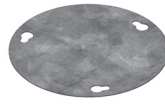
<b>DBC</b> 	<b>DEBRIS COVER</b>				
	<b>LIST PRICE</b>				
	Type No.				
	5A-DBC, 6A-DBC 5S-DBC, 6S-DBC 8A-DBC, 8S-DBC				

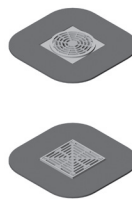
<b>WF6A WF6S</b> 	<b>NIKALOY STRAINERS FOR COMPOSITION DECKS</b>				
	<b>LIST PRICE</b>				
	Strainer	Strainer Only	With 30000†	With 30304	With 30000-ST
	6A 6S				
	<b>ADD FOR OPTIONS:</b>				

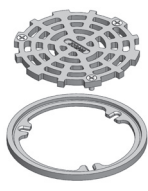





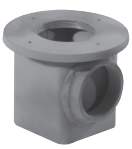





<b>NBRG</b> 	<b>1/4" NIKALOY RIM AND GRATE EXTENSION</b>			
	<b>LIST PRICE</b>			
	Type No.	NBRG	Type No. Rim Only	NBR* (1/4" Rim Only)
	5A-NBRG 6A-NBRG		5ANBR† 6ANBR	

## BODIES ONLY







<b>30000</b> 	<b>BODY ASSEMBLY</b>				
	<b>LIST PRICE</b>				
	PIPE SIZE	30000	30000-TSO	30002-ST 30003-ST	30000-PD
	2" - 4" 6" (Z)				
	<b>ADD FOR OPTIONS:</b>				

<b>30000-PD</b> 	<b>SECURITY BODY ASSEMBLY FOR PRISONS</b>			
	<b>LIST PRICE</b>			
	PIPE SIZE	30000-PD		
	2" - 3"			
	<b>ADD FOR OPTIONS:</b>			

<b>30000-TSO</b> 	<b>BODY ASSEMBLY w/THREADED SIDE OUTLET</b>			
	<b>LIST PRICE</b>			
	PIPE SIZE	30000-TSO		
	2" - 4"			
	<b>ADD FOR OPTIONS:</b>			

 <p><b>30000-ST</b></p>	<p><b>BODY ASSEMBLY w/SHALLOW THREADED OUTLET TRAP</b></p> <table border="1"> <tr><th colspan="2">LIST PRICE</th></tr> <tr><td>PIPE SIZE</td><td>30000-ST</td></tr> <tr><td>2" - 3"</td><td></td></tr> </table> <p>ADD FOR OPTIONS:</p> <table border="1"> <tr><td>-49 .....</td><td>-ARE .....</td></tr> <tr><td>-50 .....</td><td>-TSI .....</td></tr> <tr><td>-92 .....</td><td>-Z .....</td></tr> </table>	LIST PRICE		PIPE SIZE	30000-ST	2" - 3"		-49 .....	-ARE .....	-50 .....	-TSI .....	-92 .....	-Z .....	<p><b>EXPLANATION OF FLOOR DRAIN WEIGHT LOADS</b></p> <p>Apart from their primary purpose of receiving and conveying liquids, floor drains, as integral components of the floor, must be structurally suitable to withstand the anticipated loads that will be imposed on the floor. Weight support requirements of the drain vary with the location, construction, and service condition. The top loading classifications as published in Floor Drain Standard ANSI/ASME A112.6.3 are as follows:</p> <p>Light-Duty Safe Live Load under 2000 lb. (900 kg.)</p> <p>Medium-Duty Safe Live Load between 2000 lb. (900 kg.) and 4999 lb. (2250 kg.)</p> <p>Heavy-Duty Safe Live Load between 5000 lb. (2250 kg.) and 7499 lb. (3375 kg.)</p> <p>Extra Heavy-Duty Safe Live Load between 7500 lb. (3375 kg.) and 10,000 lb. (4500 kg.)</p> <p>Special-Duty Safe Live Load over 10,000 lb. (4500 kg.) should be considered special and treated accordingly.</p> <p>When the top loading requirements for a drain have been determined, the duty type needed can be resolved. Selection is easily accomplished as all JOSAM Floor Drains are classified according to duty type in this section. For specific detail loading data, contact JOSAM Engineering.</p>																																		
LIST PRICE																																																
PIPE SIZE	30000-ST																																															
2" - 3"																																																
-49 .....	-ARE .....																																															
-50 .....	-TSI .....																																															
-92 .....	-Z .....																																															
 <p><b>30304-Z</b></p>	<p><b>NO-HUB CAST IRON BODY</b></p> <table border="1"> <tr><th colspan="2">LIST PRICE</th></tr> <tr><td>PIPE SIZE</td><td>30304</td></tr> <tr><td>4"</td><td></td></tr> </table>	LIST PRICE		PIPE SIZE	30304	4"																																										
LIST PRICE																																																
PIPE SIZE	30304																																															
4"																																																
 <p><b>30500</b></p>	<p><b>BODY ASSEMBLY w/TRAP &amp; FLUSH w/FLOOR CLEANOUT</b></p> <table border="1"> <tr><th colspan="2">LIST PRICE</th></tr> <tr><td>PIPE SIZE</td><td>30500</td></tr> <tr><td>2" - 4"</td><td></td></tr> </table> <p>ADD FOR OPTIONS:</p> <table border="1"> <tr><td>-49 .....</td><td>-60 .....</td></tr> <tr><td>-50 .....</td><td>-92 .....</td></tr> <tr><td>-51 .....</td><td>-C .....</td></tr> <tr><td>-52 .....</td><td>-Z .....</td></tr> </table>	LIST PRICE		PIPE SIZE	30500	2" - 4"		-49 .....	-60 .....	-50 .....	-92 .....	-51 .....	-C .....	-52 .....	-Z .....																																	
LIST PRICE																																																
PIPE SIZE	30500																																															
2" - 4"																																																
-49 .....	-60 .....																																															
-50 .....	-92 .....																																															
-51 .....	-C .....																																															
-52 .....	-Z .....																																															
 <p><b>30802-4CP</b></p>	<p><b>BODY w/2" SHALLOW TRAP &amp; ROUND CHROME PLATED STRAINER</b></p> <table border="1"> <tr><th colspan="2">LIST PRICE</th></tr> <tr><td>PIPE SIZE</td><td>30802-4CP</td></tr> <tr><td>2"</td><td></td></tr> </table> <p>ADD FOR OPTIONS:</p> <table border="1"> <tr><td>-LT .....</td><td>-T .....</td></tr> <tr><td>-SQ .....</td><td>-Z .....</td></tr> </table>	LIST PRICE		PIPE SIZE	30802-4CP	2"		-LT .....	-T .....	-SQ .....	-Z .....																																					
LIST PRICE																																																
PIPE SIZE	30802-4CP																																															
2"																																																
-LT .....	-T .....																																															
-SQ .....	-Z .....																																															
<p><b>Option Descriptions</b></p> <table border="0"> <tr> <td style="vertical-align: top;"> <p><b>Strainers</b></p> <ul style="list-style-type: none"> <li>-ARE Acid-Resisting Epoxy</li> <li>-CP Chrome Plated</li> <li>-DBC Debris Cover</li> <li>-HD Heavy-Duty Heel Proof (Nikaloy Only)</li> <li>-J Backwater Valve</li> <li>-LT Less Shallow Trap</li> <li>-PF Perforated Standpipe</li> <li>-SC Solid Cover</li> <li>-SS Stainless Steel</li> <li>-SQ Square Top</li> <li>-TSI Trap Seal Insert</li> <li>-VP Secured Grate, Vandal-Proof Screws</li> <li>-2 Satin Finish Bronze</li> <li>-24 Less Dome</li> <li>-80 Perforated Stainless Steel Basket</li> <li>-92 Galvanized Cast Iron</li> <li>-93 Cast Iron</li> </ul> </td> <td style="vertical-align: top;"> <p><b>Bodies Only</b></p> <ul style="list-style-type: none"> <li>-ARE Acid-Resisting Epoxy</li> <li>-C Bolted Flashing Clamp Device</li> <li>-CC4 Clamp Collar with 4" Thread</li> <li>-MD PVC Clamp Collar with 3" Socket Connection</li> <li>-PD Prison Drain</li> <li>-PFB Pre-Fabricated Base</li> <li>-ST Shallow Trap</li> <li>-49 3/4" Primer Tap</li> <li>-50 1/2" Primer Tap</li> <li>-51 1-1/2" Threaded Auxiliary Inlet</li> <li>-52 2" Threaded Auxiliary Inlet</li> <li>-60 Backwater Valve</li> <li>-91 Rough Bronze Body</li> <li>-92 Galvanized Cast Iron Parts</li> </ul> <p><b>Outlets</b></p> <ul style="list-style-type: none"> <li>-T Threaded Outlet</li> <li>-TSO Threaded Side Outlet</li> <li>-X Inside Caulk Outlet</li> <li>-Y Hub Outlet with Gasket</li> <li>-YGTC -Y Outlet Gasket with Test Cap</li> <li>-Z No-Hub Outlet</li> </ul> </td> </tr> </table>		<p><b>Strainers</b></p> <ul style="list-style-type: none"> <li>-ARE Acid-Resisting Epoxy</li> <li>-CP Chrome Plated</li> <li>-DBC Debris Cover</li> <li>-HD Heavy-Duty Heel Proof (Nikaloy Only)</li> <li>-J Backwater Valve</li> <li>-LT Less Shallow Trap</li> <li>-PF Perforated Standpipe</li> <li>-SC Solid Cover</li> <li>-SS Stainless Steel</li> <li>-SQ Square Top</li> <li>-TSI Trap Seal Insert</li> <li>-VP Secured Grate, Vandal-Proof Screws</li> <li>-2 Satin Finish Bronze</li> <li>-24 Less Dome</li> <li>-80 Perforated Stainless Steel Basket</li> <li>-92 Galvanized Cast Iron</li> <li>-93 Cast Iron</li> </ul>	<p><b>Bodies Only</b></p> <ul style="list-style-type: none"> <li>-ARE Acid-Resisting Epoxy</li> <li>-C Bolted Flashing Clamp Device</li> <li>-CC4 Clamp Collar with 4" Thread</li> <li>-MD PVC Clamp Collar with 3" Socket Connection</li> <li>-PD Prison Drain</li> <li>-PFB Pre-Fabricated Base</li> <li>-ST Shallow Trap</li> <li>-49 3/4" Primer Tap</li> <li>-50 1/2" Primer Tap</li> <li>-51 1-1/2" Threaded Auxiliary Inlet</li> <li>-52 2" Threaded Auxiliary Inlet</li> <li>-60 Backwater Valve</li> <li>-91 Rough Bronze Body</li> <li>-92 Galvanized Cast Iron Parts</li> </ul> <p><b>Outlets</b></p> <ul style="list-style-type: none"> <li>-T Threaded Outlet</li> <li>-TSO Threaded Side Outlet</li> <li>-X Inside Caulk Outlet</li> <li>-Y Hub Outlet with Gasket</li> <li>-YGTC -Y Outlet Gasket with Test Cap</li> <li>-Z No-Hub Outlet</li> </ul>	<p><b>ADJUSTABLE FLOOR DRAIN ASSEMBLIES</b></p> <table border="1"> <tr> <td data-bbox="852 1060 1047 1428">  <p><b>30900-9AD</b></p> </td> <td data-bbox="1047 1060 1578 1428"> <p><b>BODY w/9" ROUND NIKALOY STRAINER</b></p> <table border="1"> <tr><th colspan="2">LIST PRICE</th></tr> <tr><td>PIPE SIZE</td><td>30900-9AD</td></tr> <tr><td>2" - 4"</td><td></td></tr> </table> <p>ADD FOR OPTIONS:</p> <table border="1"> <tr><td>-2 .....</td><td>-VP .....</td></tr> <tr><td>-66 (2", 3") .....</td><td>-X .....</td></tr> <tr><td>-66 (4") .....</td><td>-Y .....</td></tr> <tr><td>-92 .....</td><td>-Z .....</td></tr> <tr><td>-T .....</td><td>-YGTC (2"-4") .....</td></tr> <tr><td>-TSI .....</td><td></td></tr> </table> </td> </tr> <tr> <td data-bbox="852 1428 1047 1732">  <p><b>31000</b></p> </td> <td data-bbox="1047 1428 1578 1732"> <p><b>BODY w/5" ROUND NIKALOY TOP</b></p> <table border="1"> <tr><th colspan="2">LIST PRICE</th></tr> <tr><td>PIPE SIZE</td><td>31000</td></tr> <tr><td>2" - 4"</td><td></td></tr> </table> <p>ADD FOR OPTIONS:</p> <table border="1"> <tr><td>-C .....</td><td>-Y (2", 3") .....</td></tr> <tr><td>-SQ .....</td><td>-Z (3", 4") .....</td></tr> <tr><td>-TSI .....</td><td>-YGTC (2"-4") .....</td></tr> </table> </td> </tr> <tr> <td data-bbox="852 1732 1047 2022">  <p><b>31300</b></p> </td> <td data-bbox="1047 1732 1578 2022"> <p><b>BODY w/INTEGRAL TRAP AND AUXILIARY INETS</b></p> <table border="1"> <tr><th colspan="2">LIST PRICE</th></tr> <tr><td>PIPE SIZE</td><td>31300</td></tr> <tr><td>2" - 4"</td><td></td></tr> </table> <p>ADD FOR OPTIONS:</p> <table border="1"> <tr><td>-92 .....</td><td>-ARE .....</td></tr> </table> </td> </tr> </table>	 <p><b>30900-9AD</b></p>	<p><b>BODY w/9" ROUND NIKALOY STRAINER</b></p> <table border="1"> <tr><th colspan="2">LIST PRICE</th></tr> <tr><td>PIPE SIZE</td><td>30900-9AD</td></tr> <tr><td>2" - 4"</td><td></td></tr> </table> <p>ADD FOR OPTIONS:</p> <table border="1"> <tr><td>-2 .....</td><td>-VP .....</td></tr> <tr><td>-66 (2", 3") .....</td><td>-X .....</td></tr> <tr><td>-66 (4") .....</td><td>-Y .....</td></tr> <tr><td>-92 .....</td><td>-Z .....</td></tr> <tr><td>-T .....</td><td>-YGTC (2"-4") .....</td></tr> <tr><td>-TSI .....</td><td></td></tr> </table>	LIST PRICE		PIPE SIZE	30900-9AD	2" - 4"		-2 .....	-VP .....	-66 (2", 3") .....	-X .....	-66 (4") .....	-Y .....	-92 .....	-Z .....	-T .....	-YGTC (2"-4") .....	-TSI .....		 <p><b>31000</b></p>	<p><b>BODY w/5" ROUND NIKALOY TOP</b></p> <table border="1"> <tr><th colspan="2">LIST PRICE</th></tr> <tr><td>PIPE SIZE</td><td>31000</td></tr> <tr><td>2" - 4"</td><td></td></tr> </table> <p>ADD FOR OPTIONS:</p> <table border="1"> <tr><td>-C .....</td><td>-Y (2", 3") .....</td></tr> <tr><td>-SQ .....</td><td>-Z (3", 4") .....</td></tr> <tr><td>-TSI .....</td><td>-YGTC (2"-4") .....</td></tr> </table>	LIST PRICE		PIPE SIZE	31000	2" - 4"		-C .....	-Y (2", 3") .....	-SQ .....	-Z (3", 4") .....	-TSI .....	-YGTC (2"-4") .....	 <p><b>31300</b></p>	<p><b>BODY w/INTEGRAL TRAP AND AUXILIARY INETS</b></p> <table border="1"> <tr><th colspan="2">LIST PRICE</th></tr> <tr><td>PIPE SIZE</td><td>31300</td></tr> <tr><td>2" - 4"</td><td></td></tr> </table> <p>ADD FOR OPTIONS:</p> <table border="1"> <tr><td>-92 .....</td><td>-ARE .....</td></tr> </table>	LIST PRICE		PIPE SIZE	31300	2" - 4"		-92 .....	-ARE .....
<p><b>Strainers</b></p> <ul style="list-style-type: none"> <li>-ARE Acid-Resisting Epoxy</li> <li>-CP Chrome Plated</li> <li>-DBC Debris Cover</li> <li>-HD Heavy-Duty Heel Proof (Nikaloy Only)</li> <li>-J Backwater Valve</li> <li>-LT Less Shallow Trap</li> <li>-PF Perforated Standpipe</li> <li>-SC Solid Cover</li> <li>-SS Stainless Steel</li> <li>-SQ Square Top</li> <li>-TSI Trap Seal Insert</li> <li>-VP Secured Grate, Vandal-Proof Screws</li> <li>-2 Satin Finish Bronze</li> <li>-24 Less Dome</li> <li>-80 Perforated Stainless Steel Basket</li> <li>-92 Galvanized Cast Iron</li> <li>-93 Cast Iron</li> </ul>	<p><b>Bodies Only</b></p> <ul style="list-style-type: none"> <li>-ARE Acid-Resisting Epoxy</li> <li>-C Bolted Flashing Clamp Device</li> <li>-CC4 Clamp Collar with 4" Thread</li> <li>-MD PVC Clamp Collar with 3" Socket Connection</li> <li>-PD Prison Drain</li> <li>-PFB Pre-Fabricated Base</li> <li>-ST Shallow Trap</li> <li>-49 3/4" Primer Tap</li> <li>-50 1/2" Primer Tap</li> <li>-51 1-1/2" Threaded Auxiliary Inlet</li> <li>-52 2" Threaded Auxiliary Inlet</li> <li>-60 Backwater Valve</li> <li>-91 Rough Bronze Body</li> <li>-92 Galvanized Cast Iron Parts</li> </ul> <p><b>Outlets</b></p> <ul style="list-style-type: none"> <li>-T Threaded Outlet</li> <li>-TSO Threaded Side Outlet</li> <li>-X Inside Caulk Outlet</li> <li>-Y Hub Outlet with Gasket</li> <li>-YGTC -Y Outlet Gasket with Test Cap</li> <li>-Z No-Hub Outlet</li> </ul>																																															
 <p><b>30900-9AD</b></p>	<p><b>BODY w/9" ROUND NIKALOY STRAINER</b></p> <table border="1"> <tr><th colspan="2">LIST PRICE</th></tr> <tr><td>PIPE SIZE</td><td>30900-9AD</td></tr> <tr><td>2" - 4"</td><td></td></tr> </table> <p>ADD FOR OPTIONS:</p> <table border="1"> <tr><td>-2 .....</td><td>-VP .....</td></tr> <tr><td>-66 (2", 3") .....</td><td>-X .....</td></tr> <tr><td>-66 (4") .....</td><td>-Y .....</td></tr> <tr><td>-92 .....</td><td>-Z .....</td></tr> <tr><td>-T .....</td><td>-YGTC (2"-4") .....</td></tr> <tr><td>-TSI .....</td><td></td></tr> </table>	LIST PRICE		PIPE SIZE	30900-9AD	2" - 4"		-2 .....	-VP .....	-66 (2", 3") .....	-X .....	-66 (4") .....	-Y .....	-92 .....	-Z .....	-T .....	-YGTC (2"-4") .....	-TSI .....																														
LIST PRICE																																																
PIPE SIZE	30900-9AD																																															
2" - 4"																																																
-2 .....	-VP .....																																															
-66 (2", 3") .....	-X .....																																															
-66 (4") .....	-Y .....																																															
-92 .....	-Z .....																																															
-T .....	-YGTC (2"-4") .....																																															
-TSI .....																																																
 <p><b>31000</b></p>	<p><b>BODY w/5" ROUND NIKALOY TOP</b></p> <table border="1"> <tr><th colspan="2">LIST PRICE</th></tr> <tr><td>PIPE SIZE</td><td>31000</td></tr> <tr><td>2" - 4"</td><td></td></tr> </table> <p>ADD FOR OPTIONS:</p> <table border="1"> <tr><td>-C .....</td><td>-Y (2", 3") .....</td></tr> <tr><td>-SQ .....</td><td>-Z (3", 4") .....</td></tr> <tr><td>-TSI .....</td><td>-YGTC (2"-4") .....</td></tr> </table>	LIST PRICE		PIPE SIZE	31000	2" - 4"		-C .....	-Y (2", 3") .....	-SQ .....	-Z (3", 4") .....	-TSI .....	-YGTC (2"-4") .....																																			
LIST PRICE																																																
PIPE SIZE	31000																																															
2" - 4"																																																
-C .....	-Y (2", 3") .....																																															
-SQ .....	-Z (3", 4") .....																																															
-TSI .....	-YGTC (2"-4") .....																																															
 <p><b>31300</b></p>	<p><b>BODY w/INTEGRAL TRAP AND AUXILIARY INETS</b></p> <table border="1"> <tr><th colspan="2">LIST PRICE</th></tr> <tr><td>PIPE SIZE</td><td>31300</td></tr> <tr><td>2" - 4"</td><td></td></tr> </table> <p>ADD FOR OPTIONS:</p> <table border="1"> <tr><td>-92 .....</td><td>-ARE .....</td></tr> </table>	LIST PRICE		PIPE SIZE	31300	2" - 4"		-92 .....	-ARE .....																																							
LIST PRICE																																																
PIPE SIZE	31300																																															
2" - 4"																																																
-92 .....	-ARE .....																																															









FLOOR DRAINS		
	<b>32100 SUPER-FLO® 9" TOP</b>	
	<b>LIST PRICE</b>	
	PIPE SIZE	32100
	2" - 4" 6" (Z)	
ADD FOR OPTIONS:		
-1 .....	-49 .....	-LC1 .....
-2 .....	-50 .....	-LC2 .....
-7 .....	-66 .....	-PFB .....
-11 .....	-81 .....	-T .....
-13 .....	-84 .....	-TG .....
-13-1 .....	-88 .....	-TSl† .....
-13-2 .....	-92 .....	-VP .....
-15 .....	-AE† .....	-X .....
-39 .....	-ARE .....	-Y .....
-44* .....	-HP .....	-YGTC (2"-4") .....
-44-92* .....	-HP-7 .....	-Z (2" - 4") .....
* Specify Height, Each 3" or Fraction		
† Available up to 4" only		
	<b>32100-TG 9" TRACTOR TOP</b>	
	<b>LIST PRICE</b>	
	PIPE SIZE	32100-TG
	2" - 4"	
ADD FOR OPTIONS:		
-1 .....	-66 .....	-T .....
-2 .....	-81 .....	-TSl† .....
-7 .....	-84 .....	-VP .....
-15 .....	-88 .....	-X .....
-44* .....	-92 .....	-Y .....
-44-92* .....	-AE .....	-YGTC (2"-4") .....
-49 .....	-ARE .....	-Z (2" - 4") .....
-50 .....	-PFB .....	
* Specify Height, Each 3" or Fraction		
† Available up to 4" only		
	<b>32150 SUPER-FLO® 9" BLOOD DRAIN</b>	
	<b>LIST PRICE</b>	
	PIPE SIZE	32150
	2" - 4"	
ADD FOR OPTIONS:		
-1 .....	-T .....	
-2 .....	-TSl .....	
-7 .....	-X .....	
-44* .....	-Y .....	
-44-92* .....	-YGTC (2"-4") .....	
-92 .....	-Z .....	
-ARE .....		
* Specify Height, Each 3" or Fraction		
	<b>32200 SHALLOW SUMP, SUPER-FLO® 12" TOP</b>	
	<b>LIST PRICE</b>	
	PIPE SIZE	32200
	2" - 6" 8"	
ADD FOR OPTIONS:		
-1 .....	-50 .....	-PFB .....
-2 .....	-66 ◊ .....	-SD .....
-4* .....	-81 .....	-SD-1 .....
-7 .....	-84 .....	-SD-2 .....
-13 .....	-88 .....	-T .....
-13-1 .....	-92 .....	-TSl† .....
-13-2 .....	-AE .....	-VP .....
-15 .....	-ARE .....	-X .....
-44** .....	-HP .....	-Y .....
-44-92** .....	-HP-7 .....	-YGTC (2"-4") .....
-49 .....	-OR .....	-Z .....
* Available on -AE Only      † Available up to 4" only		
** Specify Height, Each 3" or Fraction      ◊ 2" - 6"		
	<b>32300 MEDIUM SUMP, SUPER-FLO® 12" TOP</b>	
	<b>LIST PRICE</b>	
	PIPE SIZE	32300
	2" - 8"	
ADD FOR OPTIONS:		
-1 .....	-49 .....	-HP .....
-2 .....	-50 .....	-SD .....
-7 .....	-66** .....	-SD-19 .....
-13 .....	-81 .....	-SD-20** .....
-13-1 .....	-84 .....	-TSl† .....
-13-2 .....	-88 .....	-VP .....
-15 .....	-92 .....	-X .....
-44* .....	-AE .....	-Z .....
-44-92* .....	-ARE .....	
* Specify Height, Each 2" or Fraction      ** 2" - 6"		
† Available up to 4" only		
	<b>32330 DEEP SUMP, SUPER-FLO® 12" TOP w/BUCKET</b>	
	<b>LIST PRICE</b>	
	PIPE SIZE	32330
	2" - 6" 8"	
ADD FOR OPTIONS:		
-15 .....	-88 .....	
-19 .....	-92 .....	
-20 .....	-SD .....	
-49 .....	-TSl† .....	
-50 .....	-VP .....	
-66** .....	-X .....	
-70 .....	-Z .....	
-84 .....		
* Specify Height, Each 3" or Fraction      ** 2" - 6"		
† Available up to 4" only		







	<b>15" EXTRA HEAVY-DUTY TOP</b>			<b>10" TRACTOR TOP w/BUCKET</b>	
	<b>LIST PRICE</b>			<b>LIST PRICE</b>	
	<b>PIPE SIZE</b>	<b>34710</b>		<b>PIPE SIZE</b>	<b>35170</b>
	2", 3", 4" 5", 6" 8"			3" - 4"	
<b>ADD FOR OPTIONS:</b>			<b>ADD FOR OPTIONS:</b>		
-7..... -88..... -VP..... -15..... -92..... -X..... -19..... -AE..... -Y..... -20..... -ARE..... -YGTC (2"-4")..... -49..... -T..... -Z..... -50..... -TSI†.....			-1..... -70..... -VP..... -2..... -84..... -X..... -15..... -88..... -Z..... -49..... -92..... -50..... -TSI.....		
†Available up to 4" only			<b>Option Descriptions</b>		
	<b>15" EXTRA HEAVY-DUTY TOP w/BUCKET</b>		-AE LEVELEZE® Adjustable Extension -ARE Acid Resisting Epoxy -C Bolted Flashing Clamp Device -HP Heel-Proof Grate -HP-7 Heel-Proof Grate, Ductile Iron -LC1 Locking Cover, Satin Finish Nikaloy -LC2 Locking Cover, Satin Finish Bronze -LT Less Shallow Trap -OR LEVELEZE® Adjustable Extension with O-Ring -PFB Pre-Fabricated Base -SD Special Duty Grate -SD-19 Special Duty, C.I. Undergrate with Satin Finish Nikaloy Top -SD-20 Special Duty, C.I. Undergrate with Satin Finish Bronze Top -SQ Square Top -TG Tractor Grate -TSI Trap Seal Insert -VP Secured Grate, Vandal-Proof Screws -1 Satin Finish Nikaloy Top -2 Satin Finish Bronze Top -4 Secondary Flashing Clamp (use with -AE only) -7 Ductile Iron Grate -11 Extra-Heavy Grate, Cast Iron -12 Square Top, Cast Iron -12-1 Square Top, Nikaloy -12-2 Square Top, Bronze -13 Dome Grate, Cast Iron -13-1 Dome Grate, Nikaloy -13-2 Dome Grate, Bronze -14-1 Hinged Top, Satin Finish Nikaloy -14-2 Hinged Top, Satin Finish Bronze -15 Chained Grate -19 C.I. Undergrate with Satin Finish Nikaloy Top -20 C.I. Undergrate with Satin Finish Bronze Top -39 Solid Cast Iron Cover -44 Fixed Extension Collar, Cast Iron, Specify Height -44-92 Fixed Extension Collar, Galvanized, Specify Height -49 3/4" Primer Tap -50 1/2" Primer Tap -51 1-1/2" Auxiliary Threaded Inlet -52 2" Auxiliary Threaded Inlet -53 2" Auxiliary Hub Inlet -54 2" Auxiliary Spigot Inlet -53-92 2" Auxiliary Hub Inlet, Galvanized -54-92 2" Auxiliary Spigot Inlet, Galvanized -60 Backwater Valve -62 "T" Handle Bronze Closure Plug -70 Less Bucket -71 Solid Cast Iron Bucket -80 Perforated Stainless Steel Basket -81 Slotted Cast Iron Bucket -84 Stainless Steel Mesh Bucket Liner -88 Supplementary Strainer -92 Galvanized Cast Iron Parts <b>Outlets</b> -66 No-Hub Side Outlet -T Threaded Outlet -TSO Threaded Side Outlet -X Inside Caulk Outlet -Y Hub Outlet with Gasket 2"-4" -YGTC -Y Outlet Gasket with Test Cap -Z No-Hub Outlet		
	<b>LIST PRICE</b>		<b>LIST PRICE</b>		
	<b>PIPE SIZE</b>	<b>34720</b>	<b>PIPE SIZE</b>		
	3" - 6"				
<b>ADD FOR OPTIONS:</b>			<b>ADD FOR OPTIONS:</b>		
-7..... -50..... -TSI†..... -15..... -66..... -VP..... -19..... -84..... -X..... -20..... -88..... -Z..... -49..... -92.....					
†Available up to 4" only					
	<b>NON-CLOG 21" ROUND TOP w/BUCKET</b>				
	<b>LIST PRICE</b>				
	<b>PIPE SIZE</b>	<b>34920</b>			
	3" - 8"				
<b>ADD FOR OPTIONS:</b>					
-12..... -49..... -C..... -12-1..... -50..... -T..... -12-2..... -66**..... -TSI†..... -15..... -80..... -VP..... -19..... -84..... -X..... -20..... -92.....					
* PRICE ON APPLICATION † Available up to 4" only ** 2" - 6"					
	<b>8" SQUARE TOP</b>				
	<b>LIST PRICE</b>				
	<b>PIPE SIZE</b>	<b>35100</b>			
	2" - 4"				
<b>ADD FOR OPTIONS:</b>					
-1..... -50..... -TSO..... -2..... -92..... -X..... -7..... -ARE..... -Y..... -15..... -T..... -YGTC (2"-4")..... -49..... -TSI..... -Z.....					
	<b>9" TOP w/BUCKET</b>				
	<b>LIST PRICE</b>				
	<b>PIPE SIZE</b>	<b>35130</b>			
	2" - 4"				
<b>ADD FOR OPTIONS:</b>					
-1..... -50..... -TSI..... -2..... -66..... -VP..... -14-1..... -70..... -X..... -14-2..... -84..... -Z..... -15..... -92..... -49..... -ARE.....					

# FLOOR DRAINS

















A WATTS Brand

 <p><b>37800</b></p>	<p><b>SHALLOW SUMP, 12" HEAVY-DUTY TOP</b></p> <table border="1"> <thead> <tr> <th colspan="2">LIST PRICE</th> </tr> </thead> <tbody> <tr> <td>PIPE SIZE</td> <td>37800</td> </tr> <tr> <td>2" - 4"</td> <td></td> </tr> </tbody> </table> <p>ADD FOR OPTIONS:</p> <table border="1"> <tbody> <tr> <td>-7</td> <td>-50</td> <td>-X</td> </tr> <tr> <td>-14</td> <td>-66</td> <td>-Y</td> </tr> <tr> <td>-18</td> <td>-92</td> <td>-YGTC (2"-4")</td> </tr> <tr> <td>-19</td> <td>-T</td> <td>-Z</td> </tr> <tr> <td>-20</td> <td>-TS†</td> <td></td> </tr> <tr> <td>-49</td> <td>-VP</td> <td></td> </tr> </tbody> </table>	LIST PRICE		PIPE SIZE	37800	2" - 4"		-7	-50	-X	-14	-66	-Y	-18	-92	-YGTC (2"-4")	-19	-T	-Z	-20	-TS†		-49	-VP		 <p><b>37900</b></p>	<p><b>14" PACKING HOUSE DRAIN</b></p> <table border="1"> <thead> <tr> <th colspan="3">LIST PRICE</th> </tr> </thead> <tbody> <tr> <td>PIPE SIZE</td> <td colspan="2">37900</td> </tr> <tr> <td>2" - 6"</td> <td colspan="2"></td> </tr> <tr> <td>8"</td> <td colspan="2"></td> </tr> </tbody> </table> <p>ADD FOR OPTIONS:</p> <table border="1"> <tbody> <tr> <td>-4</td> <td>-84</td> <td>-VP</td> </tr> <tr> <td>-15</td> <td>-88</td> <td>-X</td> </tr> <tr> <td>-19</td> <td>-92</td> <td>-Y</td> </tr> <tr> <td>-20</td> <td>-T</td> <td>-YGTC (2"-4")</td> </tr> <tr> <td>-70</td> <td>-TS†</td> <td>-Z</td> </tr> </tbody> </table> <p>†Available up to 4" only</p>	LIST PRICE			PIPE SIZE	37900		2" - 6"			8"			-4	-84	-VP	-15	-88	-X	-19	-92	-Y	-20	-T	-YGTC (2"-4")	-70	-TS†	-Z												
LIST PRICE																																																																		
PIPE SIZE	37800																																																																	
2" - 4"																																																																		
-7	-50	-X																																																																
-14	-66	-Y																																																																
-18	-92	-YGTC (2"-4")																																																																
-19	-T	-Z																																																																
-20	-TS†																																																																	
-49	-VP																																																																	
LIST PRICE																																																																		
PIPE SIZE	37900																																																																	
2" - 6"																																																																		
8"																																																																		
-4	-84	-VP																																																																
-15	-88	-X																																																																
-19	-92	-Y																																																																
-20	-T	-YGTC (2"-4")																																																																
-70	-TS†	-Z																																																																
 <p><b>37810</b></p>	<p><b>MEDIUM SUMP, 12" HEAVY-DUTY TOP</b></p> <table border="1"> <thead> <tr> <th colspan="2">LIST PRICE</th> </tr> </thead> <tbody> <tr> <td>PIPE SIZE</td> <td>37810</td> </tr> <tr> <td>2" - 6"</td> <td></td> </tr> </tbody> </table> <p>ADD FOR OPTIONS:</p> <table border="1"> <tbody> <tr> <td>-4*</td> <td>-50</td> <td>-T</td> </tr> <tr> <td>-7</td> <td>-66</td> <td>-TS†</td> </tr> <tr> <td>-14</td> <td>-70</td> <td>-VP</td> </tr> <tr> <td>-18</td> <td>-84</td> <td>-X</td> </tr> <tr> <td>-19</td> <td>-88</td> <td>-Y</td> </tr> <tr> <td>-20</td> <td>-92</td> <td>-YGTC (2"-4")</td> </tr> <tr> <td>-39</td> <td>-AE</td> <td>-Z</td> </tr> <tr> <td>-49</td> <td>-ARE</td> <td></td> </tr> </tbody> </table> <p>* Available on -AE only      †Available up to 4" only</p>	LIST PRICE		PIPE SIZE	37810	2" - 6"		-4*	-50	-T	-7	-66	-TS†	-14	-70	-VP	-18	-84	-X	-19	-88	-Y	-20	-92	-YGTC (2"-4")	-39	-AE	-Z	-49	-ARE		 <p><b>37960</b></p>	<p><b>SUPER-FLO® 16" TOP</b></p> <table border="1"> <thead> <tr> <th colspan="3">LIST PRICE</th> </tr> </thead> <tbody> <tr> <td>PIPE SIZE</td> <td colspan="2">37960</td> </tr> <tr> <td>2" - 6"</td> <td colspan="2"></td> </tr> </tbody> </table> <p>ADD FOR OPTIONS:</p> <table border="1"> <tbody> <tr> <td>-1</td> <td>-81</td> <td>-LF</td> </tr> <tr> <td>-2</td> <td>-84</td> <td>-LG</td> </tr> <tr> <td>-7</td> <td>-92</td> <td>-LG-1</td> </tr> <tr> <td>-11</td> <td>-92-LF</td> <td>-LG-2</td> </tr> <tr> <td>-15</td> <td>-92-LG-LF</td> <td>-TS†</td> </tr> <tr> <td>-49</td> <td>-ARE</td> <td>-VP*</td> </tr> <tr> <td>-50</td> <td>-C</td> <td>-X</td> </tr> </tbody> </table> <p>†Available up to 4" only      *Only available with -1 or -2</p>	LIST PRICE			PIPE SIZE	37960		2" - 6"			-1	-81	-LF	-2	-84	-LG	-7	-92	-LG-1	-11	-92-LF	-LG-2	-15	-92-LG-LF	-TS†	-49	-ARE	-VP*	-50	-C	-X			
LIST PRICE																																																																		
PIPE SIZE	37810																																																																	
2" - 6"																																																																		
-4*	-50	-T																																																																
-7	-66	-TS†																																																																
-14	-70	-VP																																																																
-18	-84	-X																																																																
-19	-88	-Y																																																																
-20	-92	-YGTC (2"-4")																																																																
-39	-AE	-Z																																																																
-49	-ARE																																																																	
LIST PRICE																																																																		
PIPE SIZE	37960																																																																	
2" - 6"																																																																		
-1	-81	-LF																																																																
-2	-84	-LG																																																																
-7	-92	-LG-1																																																																
-11	-92-LF	-LG-2																																																																
-15	-92-LG-LF	-TS†																																																																
-49	-ARE	-VP*																																																																
-50	-C	-X																																																																
 <p><b>37820</b></p>	<p><b>DEEP SUMP, 12" HEAVY-DUTY TOP w/BUCKET</b></p> <table border="1"> <thead> <tr> <th colspan="2">LIST PRICE</th> </tr> </thead> <tbody> <tr> <td>PIPE SIZE</td> <td>37820</td> </tr> <tr> <td>2" - 8"</td> <td></td> </tr> </tbody> </table> <p>ADD FOR OPTIONS:</p> <table border="1"> <tbody> <tr> <td>-4*</td> <td>-49</td> <td>-AE</td> </tr> <tr> <td>-7</td> <td>-50</td> <td>-ARE</td> </tr> <tr> <td>-14</td> <td>-66**</td> <td>-TS†</td> </tr> <tr> <td>-18</td> <td>-70</td> <td>-VP</td> </tr> <tr> <td>-19</td> <td>-84</td> <td>-X</td> </tr> <tr> <td>-20</td> <td>-88</td> <td>-Z</td> </tr> <tr> <td>-39</td> <td>-92</td> <td></td> </tr> </tbody> </table> <p>* Available on -AE only      †Available up to 4" only ** 2" - 6"</p>	LIST PRICE		PIPE SIZE	37820	2" - 8"		-4*	-49	-AE	-7	-50	-ARE	-14	-66**	-TS†	-18	-70	-VP	-19	-84	-X	-20	-88	-Z	-39	-92		 <p><b>38040</b></p>	<p><b>ROUND TOP &amp; CLEANOUT</b></p> <table border="1"> <thead> <tr> <th colspan="3">LIST PRICE</th> </tr> </thead> <tbody> <tr> <td>PIPE SIZE</td> <td colspan="2">38040</td> </tr> <tr> <td>2"</td> <td colspan="2"></td> </tr> <tr> <td>3"</td> <td colspan="2"></td> </tr> <tr> <td>4"</td> <td colspan="2"></td> </tr> </tbody> </table> <p>ADD FOR OPTIONS:</p> <table border="1"> <tbody> <tr> <td>-1</td> <td>-51</td> <td>-84</td> </tr> <tr> <td>-2</td> <td>-52</td> <td>-88</td> </tr> <tr> <td>-7</td> <td>-60* (2")</td> <td>-92</td> </tr> <tr> <td>-11</td> <td>-60* (3")</td> <td>-TS†</td> </tr> <tr> <td>-15</td> <td>-60* (4")</td> <td>-VP</td> </tr> <tr> <td>-49</td> <td>-81</td> <td>-Z</td> </tr> <tr> <td>-50</td> <td>-81-92</td> <td></td> </tr> </tbody> </table> <p>Note: When ordering/using a -81 option, the -7 and -11 options can not be used. *Can not be used with TSI</p>	LIST PRICE			PIPE SIZE	38040		2"			3"			4"			-1	-51	-84	-2	-52	-88	-7	-60* (2")	-92	-11	-60* (3")	-TS†	-15	-60* (4")	-VP	-49	-81	-Z	-50	-81-92	
LIST PRICE																																																																		
PIPE SIZE	37820																																																																	
2" - 8"																																																																		
-4*	-49	-AE																																																																
-7	-50	-ARE																																																																
-14	-66**	-TS†																																																																
-18	-70	-VP																																																																
-19	-84	-X																																																																
-20	-88	-Z																																																																
-39	-92																																																																	
LIST PRICE																																																																		
PIPE SIZE	38040																																																																	
2"																																																																		
3"																																																																		
4"																																																																		
-1	-51	-84																																																																
-2	-52	-88																																																																
-7	-60* (2")	-92																																																																
-11	-60* (3")	-TS†																																																																
-15	-60* (4")	-VP																																																																
-49	-81	-Z																																																																
-50	-81-92																																																																	
 <p><b>37830</b></p>	<p><b>12" TOP w/LATCHING GRATE</b></p> <table border="1"> <thead> <tr> <th colspan="2">LIST PRICE</th> </tr> </thead> <tbody> <tr> <td>PIPE SIZE</td> <td>37830</td> </tr> <tr> <td>2" - 6"</td> <td></td> </tr> </tbody> </table> <p>ADD FOR OPTIONS:</p> <table border="1"> <tbody> <tr> <td>-7</td> <td>-39</td> <td>-84</td> </tr> <tr> <td>-19</td> <td>-49</td> <td>-92</td> </tr> <tr> <td>-20</td> <td>-50</td> <td>-TS†</td> </tr> <tr> <td>-21</td> <td>-66</td> <td>-X</td> </tr> <tr> <td>-22</td> <td>-69</td> <td>-Z</td> </tr> </tbody> </table> <p>†Available up to 4" only</p>	LIST PRICE		PIPE SIZE	37830	2" - 6"		-7	-39	-84	-19	-49	-92	-20	-50	-TS†	-21	-66	-X	-22	-69	-Z	 <p><b>38250A</b></p>	<p><b>ROUND TOP w/CLEANOUT &amp; BWV</b></p> <table border="1"> <thead> <tr> <th colspan="3">LIST PRICE</th> </tr> </thead> <tbody> <tr> <td>PIPE SIZE</td> <td colspan="2">38250A</td> </tr> <tr> <td>2"</td> <td colspan="2"></td> </tr> <tr> <td>3"</td> <td colspan="2"></td> </tr> <tr> <td>4"</td> <td colspan="2"></td> </tr> </tbody> </table> <p>ADD FOR OPTIONS:</p> <table border="1"> <tbody> <tr> <td>-1 (2" - 3")</td> <td>-61 (2")</td> </tr> <tr> <td>-1 (4")</td> <td>-61 (3", 4")</td> </tr> <tr> <td>-2 (2" - 3")</td> <td>-92</td> </tr> <tr> <td>-2 (4")</td> <td>-VP</td> </tr> <tr> <td>-15</td> <td>-Z</td> </tr> </tbody> </table>	LIST PRICE			PIPE SIZE	38250A		2"			3"			4"			-1 (2" - 3")	-61 (2")	-1 (4")	-61 (3", 4")	-2 (2" - 3")	-92	-2 (4")	-VP	-15	-Z																	
LIST PRICE																																																																		
PIPE SIZE	37830																																																																	
2" - 6"																																																																		
-7	-39	-84																																																																
-19	-49	-92																																																																
-20	-50	-TS†																																																																
-21	-66	-X																																																																
-22	-69	-Z																																																																
LIST PRICE																																																																		
PIPE SIZE	38250A																																																																	
2"																																																																		
3"																																																																		
4"																																																																		
-1 (2" - 3")	-61 (2")																																																																	
-1 (4")	-61 (3", 4")																																																																	
-2 (2" - 3")	-92																																																																	
-2 (4")	-VP																																																																	
-15	-Z																																																																	
 <p><b>37840</b></p>	<p><b>12" TOP w/BUCKET</b></p> <table border="1"> <thead> <tr> <th colspan="2">LIST PRICE</th> </tr> </thead> <tbody> <tr> <td>PIPE SIZE</td> <td>37840</td> </tr> <tr> <td>2" - 8"</td> <td></td> </tr> </tbody> </table> <p>ADD FOR OPTIONS:</p> <table border="1"> <tbody> <tr> <td>-7</td> <td>-50</td> <td>-TS†</td> </tr> <tr> <td>-14</td> <td>-66*</td> <td>-VP</td> </tr> <tr> <td>-19</td> <td>-70</td> <td>-X</td> </tr> <tr> <td>-20</td> <td>-84</td> <td>-Z</td> </tr> <tr> <td>-39</td> <td>-88</td> <td></td> </tr> <tr> <td>-49</td> <td>-92</td> <td></td> </tr> </tbody> </table> <p>* 2" - 6"      †Available up to 4" only</p>	LIST PRICE		PIPE SIZE	37840	2" - 8"		-7	-50	-TS†	-14	-66*	-VP	-19	-70	-X	-20	-84	-Z	-39	-88		-49	-92																																										
LIST PRICE																																																																		
PIPE SIZE	37840																																																																	
2" - 8"																																																																		
-7	-50	-TS†																																																																
-14	-66*	-VP																																																																
-19	-70	-X																																																																
-20	-84	-Z																																																																
-39	-88																																																																	
-49	-92																																																																	

 <p><b>38420</b></p>	<p><b>NON-CLOG w/CLEANOUT &amp; BUCKET</b></p> <table border="1"> <thead> <tr> <th colspan="2">LIST PRICE</th> </tr> </thead> <tbody> <tr> <td>PIPE SIZE</td> <td>38420</td> </tr> <tr> <td>3", 4"</td> <td></td> </tr> </tbody> </table> <p>ADD FOR OPTIONS:</p> <table> <tr> <td>-1 .....</td> <td>-92 .....</td> </tr> <tr> <td>-2 .....</td> <td>-C .....</td> </tr> <tr> <td>-15 .....</td> <td>-IGS .....</td> </tr> <tr> <td>-60 .....</td> <td>-VP .....</td> </tr> <tr> <td>-84 .....</td> <td></td> </tr> </table>	LIST PRICE		PIPE SIZE	38420	3", 4"		-1 .....	-92 .....	-2 .....	-C .....	-15 .....	-IGS .....	-60 .....	-VP .....	-84 .....		 <p><b>38850</b></p>	<p><b>22" x 14" TOP, INTERNAL DOME STRAINER</b></p> <table border="1"> <thead> <tr> <th colspan="2">LIST PRICE</th> </tr> </thead> <tbody> <tr> <td>PIPE SIZE</td> <td>38850</td> </tr> <tr> <td>3" - 6"</td> <td></td> </tr> </tbody> </table> <p>ADD FOR OPTIONS:</p> <table> <tr> <td>-7 .....</td> <td>-TSI† .....</td> </tr> <tr> <td>-15 .....</td> <td>-VP .....</td> </tr> <tr> <td>-92 .....</td> <td>-X .....</td> </tr> </table> <p>†Available up to 4" only</p>	LIST PRICE		PIPE SIZE	38850	3" - 6"		-7 .....	-TSI† .....	-15 .....	-VP .....	-92 .....	-X .....									
LIST PRICE																																								
PIPE SIZE	38420																																							
3", 4"																																								
-1 .....	-92 .....																																							
-2 .....	-C .....																																							
-15 .....	-IGS .....																																							
-60 .....	-VP .....																																							
-84 .....																																								
LIST PRICE																																								
PIPE SIZE	38850																																							
3" - 6"																																								
-7 .....	-TSI† .....																																							
-15 .....	-VP .....																																							
-92 .....	-X .....																																							
 <p><b>38620-40</b></p>	<p><b>13" X 11" TOP w/HINGED GRATE</b></p> <table border="1"> <thead> <tr> <th colspan="2">LIST PRICE</th> </tr> </thead> <tbody> <tr> <td>PIPE SIZE</td> <td>38620-40</td> </tr> <tr> <td>3"</td> <td></td> </tr> <tr> <td>4"</td> <td></td> </tr> </tbody> </table> <p>ADD FOR OPTIONS:</p> <table> <tr> <td>-1 (3") .....</td> <td>-33 .....</td> <td>-70 .....</td> </tr> <tr> <td>-1 (4") .....</td> <td>-49 .....</td> <td>-84 .....</td> </tr> <tr> <td>-2 (3") .....</td> <td>-50 .....</td> <td>-92 .....</td> </tr> <tr> <td>-2 (4") .....</td> <td>-60* (3") .....</td> <td>-TSI .....</td> </tr> <tr> <td>-7 .....</td> <td>-60* (4") .....</td> <td>-VP .....</td> </tr> </table> <p>*Can not be used with TSI</p>	LIST PRICE		PIPE SIZE	38620-40	3"		4"		-1 (3") .....	-33 .....	-70 .....	-1 (4") .....	-49 .....	-84 .....	-2 (3") .....	-50 .....	-92 .....	-2 (4") .....	-60* (3") .....	-TSI .....	-7 .....	-60* (4") .....	-VP .....	 <p><b>38930</b></p>	<p><b>21" x 14 1/2" TOP, CLEANOUT &amp; BUCKET</b></p> <table border="1"> <thead> <tr> <th colspan="2">LIST PRICE</th> </tr> </thead> <tbody> <tr> <td>PIPE SIZE</td> <td>38930</td> </tr> <tr> <td>3", 4"</td> <td></td> </tr> </tbody> </table> <p>ADD FOR OPTIONS:</p> <table> <tr> <td>-7 .....</td> <td>-C .....</td> </tr> <tr> <td>-15 .....</td> <td>-VP .....</td> </tr> <tr> <td>-84 .....</td> <td>-X .....</td> </tr> <tr> <td>-92 .....</td> <td></td> </tr> </table>	LIST PRICE		PIPE SIZE	38930	3", 4"		-7 .....	-C .....	-15 .....	-VP .....	-84 .....	-X .....	-92 .....	
LIST PRICE																																								
PIPE SIZE	38620-40																																							
3"																																								
4"																																								
-1 (3") .....	-33 .....	-70 .....																																						
-1 (4") .....	-49 .....	-84 .....																																						
-2 (3") .....	-50 .....	-92 .....																																						
-2 (4") .....	-60* (3") .....	-TSI .....																																						
-7 .....	-60* (4") .....	-VP .....																																						
LIST PRICE																																								
PIPE SIZE	38930																																							
3", 4"																																								
-7 .....	-C .....																																							
-15 .....	-VP .....																																							
-84 .....	-X .....																																							
-92 .....																																								
 <p><b>38640</b></p>	<p><b>13" x 11" TOP w/BUCKET</b></p> <table border="1"> <thead> <tr> <th colspan="2">LIST PRICE</th> </tr> </thead> <tbody> <tr> <td>PIPE SIZE</td> <td>38640</td> </tr> <tr> <td>2" - 4"</td> <td></td> </tr> </tbody> </table> <p>ADD FOR OPTIONS:</p> <table> <tr> <td>-1 .....</td> <td>-84 .....</td> </tr> <tr> <td>-2 .....</td> <td>-92 .....</td> </tr> <tr> <td>-7 .....</td> <td>-VP .....</td> </tr> <tr> <td>-70 .....</td> <td></td> </tr> </table>	LIST PRICE		PIPE SIZE	38640	2" - 4"		-1 .....	-84 .....	-2 .....	-92 .....	-7 .....	-VP .....	-70 .....		<p><b>Option Descriptions</b></p> <ul style="list-style-type: none"> <li>-AE LEVELEZE® Adjustable Extension</li> <li>-ARE Acid Resisting Epoxy</li> <li>-C Bolted Flashing Clamp Device</li> <li>-IGS Internal Gas Seal</li> <li>-LF Less Double Drainage Flange</li> <li>-LG Less Grate, Cast Iron</li> <li>-LG-1 Less Grate, Nikaloy</li> <li>-LG-2 Less Grate, Bronze</li> <li>-TSI Trap Seal Insert</li> <li>-VP Secured Grate, Vandal-Proof Screws</li> <li>-1 Satin Finish Nikaloy Top</li> <li>-2 Satin Finish Bronze Top</li> <li>-4 Secondary Flashing Clamp (use with -AE only)</li> <li>-7 Ductile Iron Grate</li> <li>-11 Extra-Heavy Grate, Cast Iron</li> <li>-14 Hinged Grate</li> <li>-15 Chained Grate</li> <li>-18 Hinged Grate with Latching Device</li> <li>-19 C.I. Undergrate with Satin Finish Nikaloy Top</li> <li>-20 C.I. Undergrate with Satin Finish Bronze Top</li> <li>-21 Loose-Set Grate</li> <li>-22 Less Latching Device</li> <li>-33 Galvanized Bucket Only</li> <li>-39 Solid Cast Iron Cover</li> <li>-49 3/4" Primer Tap</li> <li>-50 1/2" Primer Tap</li> <li>-51 1-1/2" Auxiliary Threaded Inlet</li> <li>-52 2" Auxiliary Threaded Inlet</li> <li>-60 Backwater Valve</li> <li>-61 Less Backwater Valve</li> <li>-69 Lift Handle for Sediment Bucket</li> <li>-70 Less Bucket</li> <li>-74 Aluminum Bucket</li> <li>-81 Slotted Cast Iron Bucket</li> <li>-81-92 Slotted Cast Iron Bucket, Galvanized</li> <li>-84 Stainless Steel Mesh Bucket Liner</li> <li>-88 Supplementary Strainer</li> <li>-92 Galvanized Cast Iron Parts</li> <li>-92-LF Galv. C.I. Parts, Less Double Drainage Flange</li> <li>-92-LG-LF Galv. C.I. Parts, Less Grate and Flange</li> </ul> <p><b>Outlets</b></p> <ul style="list-style-type: none"> <li>-66 No-Hub Side Outlet</li> <li>-T Threaded Outlet</li> <li>-X Inside Caulk Outlet</li> <li>-Y Hub Outlet with Gasket, 2" - 4"</li> <li>-Z No-Hub Outlet</li> </ul>																								
LIST PRICE																																								
PIPE SIZE	38640																																							
2" - 4"																																								
-1 .....	-84 .....																																							
-2 .....	-92 .....																																							
-7 .....	-VP .....																																							
-70 .....																																								
 <p><b>38820</b></p>	<p><b>15" x 13" TOP, TRACTOR GRATE</b></p> <table border="1"> <thead> <tr> <th colspan="2">LIST PRICE</th> </tr> </thead> <tbody> <tr> <td>PIPE SIZE</td> <td>38820</td> </tr> <tr> <td>3", 4"</td> <td></td> </tr> </tbody> </table> <p>ADD FOR OPTIONS:</p> <table> <tr> <td>-1 .....</td> <td>-49 .....</td> <td>-84 .....</td> </tr> <tr> <td>-2 .....</td> <td>-50 .....</td> <td>-92 .....</td> </tr> <tr> <td>-7 .....</td> <td>-66 .....</td> <td>-TSI .....</td> </tr> <tr> <td>-15 .....</td> <td>-74 .....</td> <td>-X .....</td> </tr> <tr> <td></td> <td></td> <td>-Z .....</td> </tr> </table>	LIST PRICE		PIPE SIZE	38820	3", 4"		-1 .....	-49 .....	-84 .....	-2 .....	-50 .....	-92 .....	-7 .....	-66 .....	-TSI .....	-15 .....	-74 .....	-X .....			-Z .....																		
LIST PRICE																																								
PIPE SIZE	38820																																							
3", 4"																																								
-1 .....	-49 .....	-84 .....																																						
-2 .....	-50 .....	-92 .....																																						
-7 .....	-66 .....	-TSI .....																																						
-15 .....	-74 .....	-X .....																																						
		-Z .....																																						
 <p><b>38830</b></p>	<p><b>13-3/4" x 14-1/8" TOP w/HINGED GRATE</b></p> <table border="1"> <thead> <tr> <th colspan="2">LIST PRICE</th> </tr> </thead> <tbody> <tr> <td>PIPE SIZE</td> <td>38830</td> </tr> <tr> <td>3", 4"</td> <td></td> </tr> </tbody> </table> <p>ADD FOR OPTIONS:</p> <table> <tr> <td>-1 .....</td> <td>-50 .....</td> </tr> <tr> <td>-2 .....</td> <td>-84 .....</td> </tr> <tr> <td>-7 .....</td> <td>-92 .....</td> </tr> <tr> <td>-49 .....</td> <td>-VP .....</td> </tr> </table>	LIST PRICE		PIPE SIZE	38830	3", 4"		-1 .....	-50 .....	-2 .....	-84 .....	-7 .....	-92 .....	-49 .....	-VP .....																									
LIST PRICE																																								
PIPE SIZE	38830																																							
3", 4"																																								
-1 .....	-50 .....																																							
-2 .....	-84 .....																																							
-7 .....	-92 .....																																							
-49 .....	-VP .....																																							

# FLOOR DRAINS

 <p><b>39240</b></p>	<p><b>SQUARE CAN WASH DRAIN</b></p> <table border="1"> <tr><th colspan="2">LIST PRICE</th></tr> <tr><td>PIPE SIZE</td><td>39240</td></tr> <tr><td>3" - 4"</td><td></td></tr> </table> <p>ADD FOR OPTIONS:</p> <table border="0"> <tr><td>-1.....</td><td>-C.....</td><td>-92.....</td></tr> <tr><td>-2.....</td><td>-TSI.....</td><td>-X.....</td></tr> <tr><td>-15.....</td><td>-66.....</td><td>-Z.....</td></tr> <tr><td></td><td>-84.....</td><td></td></tr> </table>	LIST PRICE		PIPE SIZE	39240	3" - 4"		-1.....	-C.....	-92.....	-2.....	-TSI.....	-X.....	-15.....	-66.....	-Z.....		-84.....		 <p><b>49300</b></p>	<p><b>SUPER-FLO® 8" SQUARE TOP, 6" DEEP</b></p> <table border="1"> <tr><th colspan="4">LIST PRICE</th></tr> <tr><td>PIPE SIZE</td><td>49300</td><td>49300 -LF</td><td>49300 -NB</td></tr> <tr><td>2" - 4"</td><td></td><td></td><td></td></tr> </table> <p>ADD FOR OPTIONS:</p> <table border="0"> <tr><td>-3.....</td><td>-43.....</td></tr> <tr><td>-4.....</td><td>-45.....</td></tr> <tr><td>-7.....</td><td>-55**.....</td></tr> <tr><td>-8.....</td><td>-C.....</td></tr> <tr><td>-16 (ARE).....</td><td>-HG.....</td></tr> <tr><td>-16 (NB).....</td><td>-LF.....</td></tr> <tr><td>-17 (ARE).....</td><td>-LG (ARE).....</td></tr> <tr><td>-17 (NB).....</td><td>-LG (NB).....</td></tr> <tr><td>-18 (ARE).....</td><td>-NB.....</td></tr> <tr><td>-18 (NB).....</td><td>-PFB.....</td></tr> <tr><td>-20 (NB).....</td><td>-TSI.....</td></tr> <tr><td>-24 (NB).....</td><td>-VP (NB).....</td></tr> <tr><td>-31.....</td><td>-X.....</td></tr> <tr><td>-33.....</td><td>-Y†.....</td></tr> <tr><td>-35*.....</td><td>-YGTC (3"-4").....</td></tr> <tr><td></td><td>-Z.....</td></tr> </table> <p>*Specify -31 or -33 Bucket      **88450 Provided † -Y Outlet only available on 3" -LF and 4" -LF</p>	LIST PRICE				PIPE SIZE	49300	49300 -LF	49300 -NB	2" - 4"				-3.....	-43.....	-4.....	-45.....	-7.....	-55**.....	-8.....	-C.....	-16 (ARE).....	-HG.....	-16 (NB).....	-LF.....	-17 (ARE).....	-LG (ARE).....	-17 (NB).....	-LG (NB).....	-18 (ARE).....	-NB.....	-18 (NB).....	-PFB.....	-20 (NB).....	-TSI.....	-24 (NB).....	-VP (NB).....	-31.....	-X.....	-33.....	-Y†.....	-35*.....	-YGTC (3"-4").....		-Z.....																																																
LIST PRICE																																																																																																																	
PIPE SIZE	39240																																																																																																																
3" - 4"																																																																																																																	
-1.....	-C.....	-92.....																																																																																																															
-2.....	-TSI.....	-X.....																																																																																																															
-15.....	-66.....	-Z.....																																																																																																															
	-84.....																																																																																																																
LIST PRICE																																																																																																																	
PIPE SIZE	49300	49300 -LF	49300 -NB																																																																																																														
2" - 4"																																																																																																																	
-3.....	-43.....																																																																																																																
-4.....	-45.....																																																																																																																
-7.....	-55**.....																																																																																																																
-8.....	-C.....																																																																																																																
-16 (ARE).....	-HG.....																																																																																																																
-16 (NB).....	-LF.....																																																																																																																
-17 (ARE).....	-LG (ARE).....																																																																																																																
-17 (NB).....	-LG (NB).....																																																																																																																
-18 (ARE).....	-NB.....																																																																																																																
-18 (NB).....	-PFB.....																																																																																																																
-20 (NB).....	-TSI.....																																																																																																																
-24 (NB).....	-VP (NB).....																																																																																																																
-31.....	-X.....																																																																																																																
-33.....	-Y†.....																																																																																																																
-35*.....	-YGTC (3"-4").....																																																																																																																
	-Z.....																																																																																																																
 <p><b>39600</b></p>	<p><b>PLANTING AREA DRAIN</b></p> <table border="1"> <tr><th colspan="2">LIST PRICE</th></tr> <tr><td>PIPE SIZE</td><td>39600</td></tr> <tr><td>2" - 6"</td><td></td></tr> </table> <p>ADD FOR OPTIONS:</p> <table border="0"> <tr><td>-66.....</td><td>-T.....</td><td>-Z.....</td></tr> <tr><td>-89.....</td><td>-TSI†.....</td><td></td></tr> <tr><td>-92.....</td><td>-X.....</td><td></td></tr> </table> <p>†Available up to 4" only</p>	LIST PRICE		PIPE SIZE	39600	2" - 6"		-66.....	-T.....	-Z.....	-89.....	-TSI†.....		-92.....	-X.....		<p><b>49320A</b></p> 	<p><b>12" SQUARE TOP, 6" DEEP</b></p> <table border="1"> <tr><th colspan="4">LIST PRICE</th></tr> <tr><td>PIPE SIZE</td><td>49320A</td><td>49320A -LF</td><td>49320A -NB</td></tr> <tr><td>2", 3" 4", 6"</td><td></td><td></td><td></td></tr> </table> <p>ADD FOR OPTIONS:</p> <table border="0"> <tr><td>-3.....</td><td>-43.....</td></tr> <tr><td>-4.....</td><td>-45.....</td></tr> <tr><td>-5.....</td><td>-55**.....</td></tr> <tr><td>-7.....</td><td>-C.....</td></tr> <tr><td>-8.....</td><td>-LF.....</td></tr> <tr><td>-15.....</td><td>-LG (ARE).....</td></tr> <tr><td>-16 (ARE).....</td><td>-LG (NB).....</td></tr> <tr><td>-16 (NB).....</td><td>-NB.....</td></tr> <tr><td>-17 (ARE).....</td><td>-PFB.....</td></tr> <tr><td>-17 (NB).....</td><td>-HG.....</td></tr> <tr><td>-18 (ARE).....</td><td>-TSI†.....</td></tr> <tr><td>-18 (NB).....</td><td>-VP (NB).....</td></tr> <tr><td>-20 (NB).....</td><td>-X.....</td></tr> <tr><td>-24 (NB).....</td><td>-Y (2"-4").....</td></tr> <tr><td>-31.....</td><td>-YGTC (2"-4").....</td></tr> <tr><td>-33.....</td><td>-Z.....</td></tr> <tr><td>-35*.....</td><td></td></tr> </table> <p>*Specify -31 or -33 Bucket      †Available up to 4" only **88450 Provided for 2"-4". Body Primer Tapped for 6".</p>	LIST PRICE				PIPE SIZE	49320A	49320A -LF	49320A -NB	2", 3" 4", 6"				-3.....	-43.....	-4.....	-45.....	-5.....	-55**.....	-7.....	-C.....	-8.....	-LF.....	-15.....	-LG (ARE).....	-16 (ARE).....	-LG (NB).....	-16 (NB).....	-NB.....	-17 (ARE).....	-PFB.....	-17 (NB).....	-HG.....	-18 (ARE).....	-TSI†.....	-18 (NB).....	-VP (NB).....	-20 (NB).....	-X.....	-24 (NB).....	-Y (2"-4").....	-31.....	-YGTC (2"-4").....	-33.....	-Z.....	-35*.....																																																		
LIST PRICE																																																																																																																	
PIPE SIZE	39600																																																																																																																
2" - 6"																																																																																																																	
-66.....	-T.....	-Z.....																																																																																																															
-89.....	-TSI†.....																																																																																																																
-92.....	-X.....																																																																																																																
LIST PRICE																																																																																																																	
PIPE SIZE	49320A	49320A -LF	49320A -NB																																																																																																														
2", 3" 4", 6"																																																																																																																	
-3.....	-43.....																																																																																																																
-4.....	-45.....																																																																																																																
-5.....	-55**.....																																																																																																																
-7.....	-C.....																																																																																																																
-8.....	-LF.....																																																																																																																
-15.....	-LG (ARE).....																																																																																																																
-16 (ARE).....	-LG (NB).....																																																																																																																
-16 (NB).....	-NB.....																																																																																																																
-17 (ARE).....	-PFB.....																																																																																																																
-17 (NB).....	-HG.....																																																																																																																
-18 (ARE).....	-TSI†.....																																																																																																																
-18 (NB).....	-VP (NB).....																																																																																																																
-20 (NB).....	-X.....																																																																																																																
-24 (NB).....	-Y (2"-4").....																																																																																																																
-31.....	-YGTC (2"-4").....																																																																																																																
-33.....	-Z.....																																																																																																																
-35*.....																																																																																																																	
 <p><b>39720</b></p>	<p><b>11" TOP COMPOSITION DECK FLANGE</b></p> <table border="1"> <tr><th colspan="2">LIST PRICE</th></tr> <tr><td>PIPE SIZE</td><td>39720</td></tr> <tr><td>2" - 4"</td><td></td></tr> </table> <p>ADD FOR OPTIONS:</p> <table border="0"> <tr><td>-1.....</td><td>-13-2.....</td><td>-84.....</td></tr> <tr><td>-2.....</td><td>-15.....</td><td>-92.....</td></tr> <tr><td>-7.....</td><td>-TSI.....</td><td>-T.....</td></tr> <tr><td>-13.....</td><td>-VP.....</td><td>-X.....</td></tr> <tr><td>-13-1.....</td><td>-70.....</td><td></td></tr> </table>	LIST PRICE		PIPE SIZE	39720	2" - 4"		-1.....	-13-2.....	-84.....	-2.....	-15.....	-92.....	-7.....	-TSI.....	-T.....	-13.....	-VP.....	-X.....	-13-1.....	-70.....		<p><b>49320A</b></p> 	<p><b>12" SQUARE TOP, 6" DEEP</b></p> <table border="1"> <tr><th colspan="4">LIST PRICE</th></tr> <tr><td>PIPE SIZE</td><td>49320A</td><td>49320A -LF</td><td>49320A -NB</td></tr> <tr><td>2", 3" 4", 6"</td><td></td><td></td><td></td></tr> </table> <p>ADD FOR OPTIONS:</p> <table border="0"> <tr><td>-3.....</td><td>-43.....</td></tr> <tr><td>-4.....</td><td>-45.....</td></tr> <tr><td>-5.....</td><td>-55**.....</td></tr> <tr><td>-7.....</td><td>-C.....</td></tr> <tr><td>-8.....</td><td>-LF.....</td></tr> <tr><td>-15.....</td><td>-LG (ARE).....</td></tr> <tr><td>-16 (ARE).....</td><td>-LG (NB).....</td></tr> <tr><td>-16 (NB).....</td><td>-NB.....</td></tr> <tr><td>-17 (ARE).....</td><td>-PFB.....</td></tr> <tr><td>-17 (NB).....</td><td>-HG.....</td></tr> <tr><td>-18 (ARE).....</td><td>-TSI†.....</td></tr> <tr><td>-18 (NB).....</td><td>-VP (NB).....</td></tr> <tr><td>-20 (NB).....</td><td>-X.....</td></tr> <tr><td>-24 (NB).....</td><td>-Y (2"-4").....</td></tr> <tr><td>-31.....</td><td>-YGTC (2"-4").....</td></tr> <tr><td>-33.....</td><td>-Z.....</td></tr> <tr><td>-35*.....</td><td></td></tr> </table> <p>*Specify -31 or -33 Bucket      †Available up to 4" only **88450 Provided for 2"-4". Body Primer Tapped for 6".</p>	LIST PRICE				PIPE SIZE	49320A	49320A -LF	49320A -NB	2", 3" 4", 6"				-3.....	-43.....	-4.....	-45.....	-5.....	-55**.....	-7.....	-C.....	-8.....	-LF.....	-15.....	-LG (ARE).....	-16 (ARE).....	-LG (NB).....	-16 (NB).....	-NB.....	-17 (ARE).....	-PFB.....	-17 (NB).....	-HG.....	-18 (ARE).....	-TSI†.....	-18 (NB).....	-VP (NB).....	-20 (NB).....	-X.....	-24 (NB).....	-Y (2"-4").....	-31.....	-YGTC (2"-4").....	-33.....	-Z.....	-35*.....																																												
LIST PRICE																																																																																																																	
PIPE SIZE	39720																																																																																																																
2" - 4"																																																																																																																	
-1.....	-13-2.....	-84.....																																																																																																															
-2.....	-15.....	-92.....																																																																																																															
-7.....	-TSI.....	-T.....																																																																																																															
-13.....	-VP.....	-X.....																																																																																																															
-13-1.....	-70.....																																																																																																																
LIST PRICE																																																																																																																	
PIPE SIZE	49320A	49320A -LF	49320A -NB																																																																																																														
2", 3" 4", 6"																																																																																																																	
-3.....	-43.....																																																																																																																
-4.....	-45.....																																																																																																																
-5.....	-55**.....																																																																																																																
-7.....	-C.....																																																																																																																
-8.....	-LF.....																																																																																																																
-15.....	-LG (ARE).....																																																																																																																
-16 (ARE).....	-LG (NB).....																																																																																																																
-16 (NB).....	-NB.....																																																																																																																
-17 (ARE).....	-PFB.....																																																																																																																
-17 (NB).....	-HG.....																																																																																																																
-18 (ARE).....	-TSI†.....																																																																																																																
-18 (NB).....	-VP (NB).....																																																																																																																
-20 (NB).....	-X.....																																																																																																																
-24 (NB).....	-Y (2"-4").....																																																																																																																
-31.....	-YGTC (2"-4").....																																																																																																																
-33.....	-Z.....																																																																																																																
-35*.....																																																																																																																	
 <p><b>39960</b></p>	<p><b>SQUARE TOP w/HINGED GRATE</b></p> <table border="1"> <tr><th colspan="2">LIST PRICE</th></tr> <tr><td>PIPE SIZE</td><td>39960</td></tr> <tr><td>2" 3"</td><td></td></tr> </table> <p>ADD FOR OPTIONS:</p> <table border="0"> <tr><td>-VP.....</td><td>-92.....</td></tr> <tr><td>-ARE.....</td><td>-X.....</td></tr> <tr><td>-TSI.....</td><td></td></tr> </table>	LIST PRICE		PIPE SIZE	39960	2" 3"		-VP.....	-92.....	-ARE.....	-X.....	-TSI.....		<p><b>49320A</b></p> 	<p><b>12" SQUARE TOP, 6" DEEP</b></p> <table border="1"> <tr><th colspan="4">LIST PRICE</th></tr> <tr><td>PIPE SIZE</td><td>49320A</td><td>49320A -LF</td><td>49320A -NB</td></tr> <tr><td>2", 3" 4", 6"</td><td></td><td></td><td></td></tr> </table> <p>ADD FOR OPTIONS:</p> <table border="0"> <tr><td>-3.....</td><td>-43.....</td></tr> <tr><td>-4.....</td><td>-45.....</td></tr> <tr><td>-5.....</td><td>-55**.....</td></tr> <tr><td>-7.....</td><td>-C.....</td></tr> <tr><td>-8.....</td><td>-LF.....</td></tr> <tr><td>-15.....</td><td>-LG (ARE).....</td></tr> <tr><td>-16 (ARE).....</td><td>-LG (NB).....</td></tr> <tr><td>-16 (NB).....</td><td>-NB.....</td></tr> <tr><td>-17 (ARE).....</td><td>-PFB.....</td></tr> <tr><td>-17 (NB).....</td><td>-HG.....</td></tr> <tr><td>-18 (ARE).....</td><td>-TSI†.....</td></tr> <tr><td>-18 (NB).....</td><td>-VP (NB).....</td></tr> <tr><td>-20 (NB).....</td><td>-X.....</td></tr> <tr><td>-24 (NB).....</td><td>-Y (2"-4").....</td></tr> <tr><td>-31.....</td><td>-YGTC (2"-4").....</td></tr> <tr><td>-33.....</td><td>-Z.....</td></tr> <tr><td>-35*.....</td><td></td></tr> </table> <p>*Specify -31 or -33 Bucket      †Available up to 4" only **88450 Provided for 2"-4". Body Primer Tapped for 6".</p>	LIST PRICE				PIPE SIZE	49320A	49320A -LF	49320A -NB	2", 3" 4", 6"				-3.....	-43.....	-4.....	-45.....	-5.....	-55**.....	-7.....	-C.....	-8.....	-LF.....	-15.....	-LG (ARE).....	-16 (ARE).....	-LG (NB).....	-16 (NB).....	-NB.....	-17 (ARE).....	-PFB.....	-17 (NB).....	-HG.....	-18 (ARE).....	-TSI†.....	-18 (NB).....	-VP (NB).....	-20 (NB).....	-X.....	-24 (NB).....	-Y (2"-4").....	-31.....	-YGTC (2"-4").....	-33.....	-Z.....	-35*.....																																																					
LIST PRICE																																																																																																																	
PIPE SIZE	39960																																																																																																																
2" 3"																																																																																																																	
-VP.....	-92.....																																																																																																																
-ARE.....	-X.....																																																																																																																
-TSI.....																																																																																																																	
LIST PRICE																																																																																																																	
PIPE SIZE	49320A	49320A -LF	49320A -NB																																																																																																														
2", 3" 4", 6"																																																																																																																	
-3.....	-43.....																																																																																																																
-4.....	-45.....																																																																																																																
-5.....	-55**.....																																																																																																																
-7.....	-C.....																																																																																																																
-8.....	-LF.....																																																																																																																
-15.....	-LG (ARE).....																																																																																																																
-16 (ARE).....	-LG (NB).....																																																																																																																
-16 (NB).....	-NB.....																																																																																																																
-17 (ARE).....	-PFB.....																																																																																																																
-17 (NB).....	-HG.....																																																																																																																
-18 (ARE).....	-TSI†.....																																																																																																																
-18 (NB).....	-VP (NB).....																																																																																																																
-20 (NB).....	-X.....																																																																																																																
-24 (NB).....	-Y (2"-4").....																																																																																																																
-31.....	-YGTC (2"-4").....																																																																																																																
-33.....	-Z.....																																																																																																																
-35*.....																																																																																																																	
<p><b>Floor Drain Option Descriptions</b></p> <table border="0"> <tr><td>-ARE</td><td>Acid Resisting Epoxy</td></tr> <tr><td>-C</td><td>Bolted Flushing Clamp Device</td></tr> <tr><td>-TSI</td><td>Trap Seal Insert</td></tr> <tr><td>-VP</td><td>Secured Grate, Vandal-Proof Screws</td></tr> <tr><td>-1</td><td>Satin Finish Nikaloy Top</td></tr> <tr><td>-2</td><td>Satin Finish Bronze Top</td></tr> <tr><td>-7</td><td>Ductile Iron Grate</td></tr> <tr><td>-13</td><td>Dome Grate, Cast Iron</td></tr> <tr><td>-13-1</td><td>Dome Grate, Nikaloy</td></tr> <tr><td>-13-2</td><td>Dome Grate, Bronze</td></tr> <tr><td>-15</td><td>Chained Grate</td></tr> <tr><td>-70</td><td>Less Bucket</td></tr> <tr><td>-84</td><td>Stainless Steel Mesh Bucket Liner</td></tr> <tr><td>-89</td><td>Deck Clamp Assembly</td></tr> <tr><td>-92</td><td>Galvanized Cast Iron Parts</td></tr> </table> <p>Outlets</p> <table border="0"> <tr><td>-66</td><td>No-Hub Side Outlet</td></tr> <tr><td>-T</td><td>Threaded Outlet</td></tr> <tr><td>-X</td><td>Inside Caulk Outlet</td></tr> <tr><td>-Z</td><td>No-Hub Outlet</td></tr> </table>		-ARE	Acid Resisting Epoxy	-C	Bolted Flushing Clamp Device	-TSI	Trap Seal Insert	-VP	Secured Grate, Vandal-Proof Screws	-1	Satin Finish Nikaloy Top	-2	Satin Finish Bronze Top	-7	Ductile Iron Grate	-13	Dome Grate, Cast Iron	-13-1	Dome Grate, Nikaloy	-13-2	Dome Grate, Bronze	-15	Chained Grate	-70	Less Bucket	-84	Stainless Steel Mesh Bucket Liner	-89	Deck Clamp Assembly	-92	Galvanized Cast Iron Parts	-66	No-Hub Side Outlet	-T	Threaded Outlet	-X	Inside Caulk Outlet	-Z	No-Hub Outlet	<p><b>Sanitary Floor Sink Option Descriptions</b></p> <table border="0"> <tr><td>-C</td><td>Clamp Device</td><td>-31</td><td>Sediment Bucket (Aluminum)</td></tr> <tr><td>-LF</td><td>Less Flange</td><td>-32</td><td>Shallow Sediment Bucket (Aluminum)</td></tr> <tr><td>-LG</td><td>Less Grate</td><td>-33</td><td>Sediment Bucket (A.R. Finish)</td></tr> <tr><td>-HG</td><td>Hinged Grate (-NB Only)</td><td>-35</td><td>Stainless Steel Mesh Bucket Liner</td></tr> <tr><td>-NB</td><td>Nickel Bronze Traffic Top</td><td>-43</td><td>Internal Dome Strainer (A.R. Finish)</td></tr> <tr><td>-TSI</td><td>Trap Seal Insert</td><td>-45</td><td>Less Internal Dome Strainer</td></tr> <tr><td>-VP</td><td>Secured Grate, Vandal-Proof Screws</td><td>-51</td><td>Galvanized Cast Iron Inside and Outside</td></tr> <tr><td>-3</td><td>1/2 Grate</td><td>-52</td><td>Painted Inside and Outside</td></tr> <tr><td>-4</td><td>3/4 Grate</td><td>-55</td><td>1/2" Primer Tap or Adapter</td></tr> <tr><td>-5</td><td>Nikaloy Extra Heavy-Duty Grate &amp; Rim (Not SUPER-FLO® Design)</td><td></td><td>Outlets</td></tr> <tr><td>-7</td><td>Full Grate w/ 2-1/2" Center Opening</td><td>-X</td><td>Inside Caulk Outlet</td></tr> <tr><td>-8</td><td>Stainless Steel Depressed Grate</td><td>-Y</td><td>Hub Outlet w/Gasket 2"-4"</td></tr> <tr><td>-15</td><td>Stainless Steel Rim and Grate</td><td>-YGTC</td><td>-Y Outlet Gasket w/Test Cap</td></tr> <tr><td>-16</td><td>Grate with 4" Round Funnel</td><td>Z</td><td>No-Hub Outlet</td></tr> <tr><td>-17</td><td>Grate with 6" Round Funnel</td><td></td><td></td></tr> <tr><td>-18</td><td>Grate with 9" x 3-1/2" Oval Funnel</td><td></td><td></td></tr> <tr><td>-20</td><td>Solid Nikaloy Cover</td><td></td><td></td></tr> <tr><td>-24</td><td>Chained Grate</td><td></td><td></td></tr> </table>		-C	Clamp Device	-31	Sediment Bucket (Aluminum)	-LF	Less Flange	-32	Shallow Sediment Bucket (Aluminum)	-LG	Less Grate	-33	Sediment Bucket (A.R. Finish)	-HG	Hinged Grate (-NB Only)	-35	Stainless Steel Mesh Bucket Liner	-NB	Nickel Bronze Traffic Top	-43	Internal Dome Strainer (A.R. Finish)	-TSI	Trap Seal Insert	-45	Less Internal Dome Strainer	-VP	Secured Grate, Vandal-Proof Screws	-51	Galvanized Cast Iron Inside and Outside	-3	1/2 Grate	-52	Painted Inside and Outside	-4	3/4 Grate	-55	1/2" Primer Tap or Adapter	-5	Nikaloy Extra Heavy-Duty Grate & Rim (Not SUPER-FLO® Design)		Outlets	-7	Full Grate w/ 2-1/2" Center Opening	-X	Inside Caulk Outlet	-8	Stainless Steel Depressed Grate	-Y	Hub Outlet w/Gasket 2"-4"	-15	Stainless Steel Rim and Grate	-YGTC	-Y Outlet Gasket w/Test Cap	-16	Grate with 4" Round Funnel	Z	No-Hub Outlet	-17	Grate with 6" Round Funnel			-18	Grate with 9" x 3-1/2" Oval Funnel			-20	Solid Nikaloy Cover			-24	Chained Grate		
-ARE	Acid Resisting Epoxy																																																																																																																
-C	Bolted Flushing Clamp Device																																																																																																																
-TSI	Trap Seal Insert																																																																																																																
-VP	Secured Grate, Vandal-Proof Screws																																																																																																																
-1	Satin Finish Nikaloy Top																																																																																																																
-2	Satin Finish Bronze Top																																																																																																																
-7	Ductile Iron Grate																																																																																																																
-13	Dome Grate, Cast Iron																																																																																																																
-13-1	Dome Grate, Nikaloy																																																																																																																
-13-2	Dome Grate, Bronze																																																																																																																
-15	Chained Grate																																																																																																																
-70	Less Bucket																																																																																																																
-84	Stainless Steel Mesh Bucket Liner																																																																																																																
-89	Deck Clamp Assembly																																																																																																																
-92	Galvanized Cast Iron Parts																																																																																																																
-66	No-Hub Side Outlet																																																																																																																
-T	Threaded Outlet																																																																																																																
-X	Inside Caulk Outlet																																																																																																																
-Z	No-Hub Outlet																																																																																																																
-C	Clamp Device	-31	Sediment Bucket (Aluminum)																																																																																																														
-LF	Less Flange	-32	Shallow Sediment Bucket (Aluminum)																																																																																																														
-LG	Less Grate	-33	Sediment Bucket (A.R. Finish)																																																																																																														
-HG	Hinged Grate (-NB Only)	-35	Stainless Steel Mesh Bucket Liner																																																																																																														
-NB	Nickel Bronze Traffic Top	-43	Internal Dome Strainer (A.R. Finish)																																																																																																														
-TSI	Trap Seal Insert	-45	Less Internal Dome Strainer																																																																																																														
-VP	Secured Grate, Vandal-Proof Screws	-51	Galvanized Cast Iron Inside and Outside																																																																																																														
-3	1/2 Grate	-52	Painted Inside and Outside																																																																																																														
-4	3/4 Grate	-55	1/2" Primer Tap or Adapter																																																																																																														
-5	Nikaloy Extra Heavy-Duty Grate & Rim (Not SUPER-FLO® Design)		Outlets																																																																																																														
-7	Full Grate w/ 2-1/2" Center Opening	-X	Inside Caulk Outlet																																																																																																														
-8	Stainless Steel Depressed Grate	-Y	Hub Outlet w/Gasket 2"-4"																																																																																																														
-15	Stainless Steel Rim and Grate	-YGTC	-Y Outlet Gasket w/Test Cap																																																																																																														
-16	Grate with 4" Round Funnel	Z	No-Hub Outlet																																																																																																														
-17	Grate with 6" Round Funnel																																																																																																																
-18	Grate with 9" x 3-1/2" Oval Funnel																																																																																																																
-20	Solid Nikaloy Cover																																																																																																																
-24	Chained Grate																																																																																																																

 <p><b>49340A</b></p>	<p><b>12" SQUARE TOP, 8" DEEP</b></p> <table border="1"> <thead> <tr> <th colspan="5">LIST PRICE</th> </tr> <tr> <th>PIPE SIZE</th> <th>49340A</th> <th>49340A -LF</th> <th>49340A -NB</th> <th>49340A -LF-NB</th> </tr> </thead> <tbody> <tr> <td>2" - 4"</td> <td></td> <td></td> <td></td> <td></td> </tr> </tbody> </table> <p>ADD FOR OPTIONS:</p> <table> <tr><td>-3 .....</td><td>-43 .....</td></tr> <tr><td>-4 .....</td><td>-45 .....</td></tr> <tr><td>-5 .....</td><td>-55** .....</td></tr> <tr><td>-7 .....</td><td>-C .....</td></tr> <tr><td>-8 .....</td><td>-HG .....</td></tr> <tr><td>-15 .....</td><td>-LF .....</td></tr> <tr><td>-16 (ARE) .....</td><td>-LG (ARE) .....</td></tr> <tr><td>-16 (NB) .....</td><td>-LG (NB) .....</td></tr> <tr><td>-17 (ARE) .....</td><td>-NB .....</td></tr> <tr><td>-17 (NB) .....</td><td>-PFB .....</td></tr> <tr><td>-18 (ARE) .....</td><td>-TSI .....</td></tr> <tr><td>-18 (NB) .....</td><td>-VP (NB) .....</td></tr> <tr><td>-20 (NB) .....</td><td>-X .....</td></tr> <tr><td>-24 (NB) .....</td><td>-Y .....</td></tr> <tr><td>-31 .....</td><td>-YGTC (2"-4") .....</td></tr> <tr><td>-33 .....</td><td>-Z .....</td></tr> <tr><td>-35* .....</td><td></td></tr> </table> <p>*Specify -31 or -33 Bucket      **88450 Provided</p>	LIST PRICE					PIPE SIZE	49340A	49340A -LF	49340A -NB	49340A -LF-NB	2" - 4"					-3 .....	-43 .....	-4 .....	-45 .....	-5 .....	-55** .....	-7 .....	-C .....	-8 .....	-HG .....	-15 .....	-LF .....	-16 (ARE) .....	-LG (ARE) .....	-16 (NB) .....	-LG (NB) .....	-17 (ARE) .....	-NB .....	-17 (NB) .....	-PFB .....	-18 (ARE) .....	-TSI .....	-18 (NB) .....	-VP (NB) .....	-20 (NB) .....	-X .....	-24 (NB) .....	-Y .....	-31 .....	-YGTC (2"-4") .....	-33 .....	-Z .....	-35* .....		 <p><b>49420</b></p>	<p><b>SUPER-FLO® 16" SQUARE TOP, 12" DEEP</b></p> <table border="1"> <thead> <tr> <th colspan="5">LIST PRICE</th> </tr> <tr> <th>PIPE SIZE</th> <th>49420</th> <th>49420 -LF</th> <th>49420 -NB</th> <th>49420 -LF-NB</th> </tr> </thead> <tbody> <tr> <td>3", 4", 6"</td> <td></td> <td></td> <td></td> <td></td> </tr> </tbody> </table> <p>ADD FOR OPTIONS:</p> <table> <tr><td>-3 .....</td><td>-43 .....</td></tr> <tr><td>-4 .....</td><td>-45 .....</td></tr> <tr><td>-7 .....</td><td>-55** .....</td></tr> <tr><td>-16 (ARE) .....</td><td>-C .....</td></tr> <tr><td>-16 (NB) .....</td><td>-LF .....</td></tr> <tr><td>-17 (ARE) .....</td><td>-LG (ARE) .....</td></tr> <tr><td>-17 (NB) .....</td><td>-LG (NB) .....</td></tr> <tr><td>-18 (ARE) .....</td><td>-NB .....</td></tr> <tr><td>-18 (NB) .....</td><td>-TSI† .....</td></tr> <tr><td>-31 .....</td><td>-VP (NB) .....</td></tr> <tr><td>-33 .....</td><td>-X .....</td></tr> <tr><td>-35* .....</td><td>-Z (4" &amp; 6") .....</td></tr> </table> <p>* Specify -31 or -33 Bucket  ** 88450 Provided for 3" &amp; 4". Body Primer Tapped for 6"  † Available up to 4" only</p>	LIST PRICE					PIPE SIZE	49420	49420 -LF	49420 -NB	49420 -LF-NB	3", 4", 6"					-3 .....	-43 .....	-4 .....	-45 .....	-7 .....	-55** .....	-16 (ARE) .....	-C .....	-16 (NB) .....	-LF .....	-17 (ARE) .....	-LG (ARE) .....	-17 (NB) .....	-LG (NB) .....	-18 (ARE) .....	-NB .....	-18 (NB) .....	-TSI† .....	-31 .....	-VP (NB) .....	-33 .....	-X .....	-35* .....	-Z (4" & 6") .....		
LIST PRICE																																																																																													
PIPE SIZE	49340A	49340A -LF	49340A -NB	49340A -LF-NB																																																																																									
2" - 4"																																																																																													
-3 .....	-43 .....																																																																																												
-4 .....	-45 .....																																																																																												
-5 .....	-55** .....																																																																																												
-7 .....	-C .....																																																																																												
-8 .....	-HG .....																																																																																												
-15 .....	-LF .....																																																																																												
-16 (ARE) .....	-LG (ARE) .....																																																																																												
-16 (NB) .....	-LG (NB) .....																																																																																												
-17 (ARE) .....	-NB .....																																																																																												
-17 (NB) .....	-PFB .....																																																																																												
-18 (ARE) .....	-TSI .....																																																																																												
-18 (NB) .....	-VP (NB) .....																																																																																												
-20 (NB) .....	-X .....																																																																																												
-24 (NB) .....	-Y .....																																																																																												
-31 .....	-YGTC (2"-4") .....																																																																																												
-33 .....	-Z .....																																																																																												
-35* .....																																																																																													
LIST PRICE																																																																																													
PIPE SIZE	49420	49420 -LF	49420 -NB	49420 -LF-NB																																																																																									
3", 4", 6"																																																																																													
-3 .....	-43 .....																																																																																												
-4 .....	-45 .....																																																																																												
-7 .....	-55** .....																																																																																												
-16 (ARE) .....	-C .....																																																																																												
-16 (NB) .....	-LF .....																																																																																												
-17 (ARE) .....	-LG (ARE) .....																																																																																												
-17 (NB) .....	-LG (NB) .....																																																																																												
-18 (ARE) .....	-NB .....																																																																																												
-18 (NB) .....	-TSI† .....																																																																																												
-31 .....	-VP (NB) .....																																																																																												
-33 .....	-X .....																																																																																												
-35* .....	-Z (4" & 6") .....																																																																																												
 <p><b>49360A</b></p>	<p><b>12" SQUARE TOP, 10" DEEP</b></p> <table border="1"> <thead> <tr> <th colspan="5">LIST PRICE</th> </tr> <tr> <th>PIPE SIZE</th> <th>49360A</th> <th>49360A -LF</th> <th>49360A -NB</th> <th>49360A -LF-NB</th> </tr> </thead> <tbody> <tr> <td>2" - 4"</td> <td></td> <td></td> <td></td> <td></td> </tr> </tbody> </table> <p>ADD FOR OPTIONS:</p> <table> <tr><td>-3 .....</td><td>-35* .....</td></tr> <tr><td>-4 .....</td><td>-43 .....</td></tr> <tr><td>-5 .....</td><td>-45 .....</td></tr> <tr><td>-7 .....</td><td>-55** .....</td></tr> <tr><td>-8 .....</td><td>-C .....</td></tr> <tr><td>-15 .....</td><td>-HG .....</td></tr> <tr><td>-16 (ARE) .....</td><td>-LF .....</td></tr> <tr><td>-16 (NB) .....</td><td>-LG (ARE) .....</td></tr> <tr><td>-17 (ARE) .....</td><td>-LG (NB) .....</td></tr> <tr><td>-17 (NB) .....</td><td>-NB .....</td></tr> <tr><td>-18 (ARE) .....</td><td>-PFB .....</td></tr> <tr><td>-18 (NB) .....</td><td>-TSI .....</td></tr> <tr><td>-20 (NB) .....</td><td>-VP (NB) .....</td></tr> <tr><td>-24 (NB) .....</td><td>-X .....</td></tr> <tr><td>-31 .....</td><td>-Y .....</td></tr> <tr><td>-32 .....</td><td>-YGTC (2"-4") .....</td></tr> <tr><td>-33 .....</td><td>-Z .....</td></tr> </table> <p>* Specify -31 or -33 Bucket      **88450 Provided</p>	LIST PRICE					PIPE SIZE	49360A	49360A -LF	49360A -NB	49360A -LF-NB	2" - 4"					-3 .....	-35* .....	-4 .....	-43 .....	-5 .....	-45 .....	-7 .....	-55** .....	-8 .....	-C .....	-15 .....	-HG .....	-16 (ARE) .....	-LF .....	-16 (NB) .....	-LG (ARE) .....	-17 (ARE) .....	-LG (NB) .....	-17 (NB) .....	-NB .....	-18 (ARE) .....	-PFB .....	-18 (NB) .....	-TSI .....	-20 (NB) .....	-VP (NB) .....	-24 (NB) .....	-X .....	-31 .....	-Y .....	-32 .....	-YGTC (2"-4") .....	-33 .....	-Z .....	 <p><b>49500</b></p>	<p><b>SUPER-FLO® 8" ROUND TOP, 3" DEEP</b></p> <table border="1"> <thead> <tr> <th colspan="5">LIST PRICE</th> </tr> <tr> <th>PIPE SIZE</th> <th>49500</th> <th>49500 -LF</th> <th>49500 -NB</th> <th>49500 -LF-NB</th> </tr> </thead> <tbody> <tr> <td>2" - 4"</td> <td></td> <td></td> <td></td> <td></td> </tr> </tbody> </table> <p>ADD FOR OPTIONS:</p> <table> <tr><td>-3 .....</td><td>-43 .....</td></tr> <tr><td>-4 .....</td><td>-45 .....</td></tr> <tr><td>-7 .....</td><td>-51 .....</td></tr> <tr><td>-8 .....</td><td>-52 .....</td></tr> <tr><td>-16 (ARE) .....</td><td>-55** .....</td></tr> <tr><td>-16 (NB) .....</td><td>-C .....</td></tr> <tr><td>-17 (ARE) .....</td><td>-LF .....</td></tr> <tr><td>-17 (NB) .....</td><td>-LG (ARE) .....</td></tr> <tr><td>-18 (ARE) .....</td><td>-LG (NB) .....</td></tr> <tr><td>-18 (NB) .....</td><td>-NB .....</td></tr> <tr><td>-31 .....</td><td>-TSI .....</td></tr> <tr><td>-33 .....</td><td>-X .....</td></tr> <tr><td>-35* .....</td><td>-VP (NB) .....</td></tr> </table> <p>* Specify -31 or -33 Bucket      **88450 Provided</p>	LIST PRICE					PIPE SIZE	49500	49500 -LF	49500 -NB	49500 -LF-NB	2" - 4"					-3 .....	-43 .....	-4 .....	-45 .....	-7 .....	-51 .....	-8 .....	-52 .....	-16 (ARE) .....	-55** .....	-16 (NB) .....	-C .....	-17 (ARE) .....	-LF .....	-17 (NB) .....	-LG (ARE) .....	-18 (ARE) .....	-LG (NB) .....	-18 (NB) .....	-NB .....	-31 .....	-TSI .....	-33 .....	-X .....	-35* .....	-VP (NB) .....
LIST PRICE																																																																																													
PIPE SIZE	49360A	49360A -LF	49360A -NB	49360A -LF-NB																																																																																									
2" - 4"																																																																																													
-3 .....	-35* .....																																																																																												
-4 .....	-43 .....																																																																																												
-5 .....	-45 .....																																																																																												
-7 .....	-55** .....																																																																																												
-8 .....	-C .....																																																																																												
-15 .....	-HG .....																																																																																												
-16 (ARE) .....	-LF .....																																																																																												
-16 (NB) .....	-LG (ARE) .....																																																																																												
-17 (ARE) .....	-LG (NB) .....																																																																																												
-17 (NB) .....	-NB .....																																																																																												
-18 (ARE) .....	-PFB .....																																																																																												
-18 (NB) .....	-TSI .....																																																																																												
-20 (NB) .....	-VP (NB) .....																																																																																												
-24 (NB) .....	-X .....																																																																																												
-31 .....	-Y .....																																																																																												
-32 .....	-YGTC (2"-4") .....																																																																																												
-33 .....	-Z .....																																																																																												
LIST PRICE																																																																																													
PIPE SIZE	49500	49500 -LF	49500 -NB	49500 -LF-NB																																																																																									
2" - 4"																																																																																													
-3 .....	-43 .....																																																																																												
-4 .....	-45 .....																																																																																												
-7 .....	-51 .....																																																																																												
-8 .....	-52 .....																																																																																												
-16 (ARE) .....	-55** .....																																																																																												
-16 (NB) .....	-C .....																																																																																												
-17 (ARE) .....	-LF .....																																																																																												
-17 (NB) .....	-LG (ARE) .....																																																																																												
-18 (ARE) .....	-LG (NB) .....																																																																																												
-18 (NB) .....	-NB .....																																																																																												
-31 .....	-TSI .....																																																																																												
-33 .....	-X .....																																																																																												
-35* .....	-VP (NB) .....																																																																																												
 <p><b>49400</b></p>	<p><b>SUPER-FLO® 16" SQUARE TOP, 6" DEEP</b></p> <table border="1"> <thead> <tr> <th colspan="5">LIST PRICE</th> </tr> <tr> <th>PIPE SIZE</th> <th>49400</th> <th>49400 -LF</th> <th>49400 -NB</th> <th>49400 -LF-NB</th> </tr> </thead> <tbody> <tr> <td>2", 4", 6"</td> <td></td> <td></td> <td></td> <td></td> </tr> </tbody> </table> <p>ADD FOR OPTIONS:</p> <table> <tr><td>-3 .....</td><td>-43 .....</td></tr> <tr><td>-4 .....</td><td>-45 .....</td></tr> <tr><td>-7 .....</td><td>-55** .....</td></tr> <tr><td>-16 (ARE) .....</td><td>-C .....</td></tr> <tr><td>-16 (NB) .....</td><td>-LF .....</td></tr> <tr><td>-17 (ARE) .....</td><td>-LG (ARE) .....</td></tr> <tr><td>-17 (NB) .....</td><td>-LG (NB) .....</td></tr> <tr><td>-18 (ARE) .....</td><td>-NB .....</td></tr> <tr><td>-18 (NB) .....</td><td>-TSI† .....</td></tr> <tr><td>-31 .....</td><td>-VP (NB) .....</td></tr> <tr><td>-33 .....</td><td>-X .....</td></tr> <tr><td>-35* .....</td><td>-Z (4" &amp; 6") .....</td></tr> </table> <p>* Specify -31 or -33 Bucket  ** 88450 Provided for 3" &amp; 4". Body Primer Tapped for 6"  † Available up to 4" only</p>	LIST PRICE					PIPE SIZE	49400	49400 -LF	49400 -NB	49400 -LF-NB	2", 4", 6"					-3 .....	-43 .....	-4 .....	-45 .....	-7 .....	-55** .....	-16 (ARE) .....	-C .....	-16 (NB) .....	-LF .....	-17 (ARE) .....	-LG (ARE) .....	-17 (NB) .....	-LG (NB) .....	-18 (ARE) .....	-NB .....	-18 (NB) .....	-TSI† .....	-31 .....	-VP (NB) .....	-33 .....	-X .....	-35* .....	-Z (4" & 6") .....	 <p><b>49520A</b></p>	<p><b>SUPER-FLO® 8" ROUND TOP, 6" DEEP</b></p> <table border="1"> <thead> <tr> <th colspan="5">LIST PRICE</th> </tr> <tr> <th>PIPE SIZE</th> <th>49520A</th> <th>49520A -LF</th> <th>49520A -NB</th> <th>49520A -LF-NB</th> </tr> </thead> <tbody> <tr> <td>2" - 4"</td> <td></td> <td></td> <td></td> <td></td> </tr> </tbody> </table> <p>ADD FOR OPTIONS:</p> <table> <tr><td>-3 .....</td><td>-45 .....</td></tr> <tr><td>-4 .....</td><td>-51 .....</td></tr> <tr><td>-7 .....</td><td>-52 .....</td></tr> <tr><td>-8 .....</td><td>-55** .....</td></tr> <tr><td>-16 (ARE) .....</td><td>-C .....</td></tr> <tr><td>-16 (NB) .....</td><td>-LF .....</td></tr> <tr><td>-17 (ARE) .....</td><td>-LG (ARE) .....</td></tr> <tr><td>-17 (NB) .....</td><td>-LG (NB) .....</td></tr> <tr><td>-18 (ARE) .....</td><td>-NB .....</td></tr> <tr><td>-18 (NB) .....</td><td>-TSI .....</td></tr> <tr><td>-31 .....</td><td>-VP (NB) .....</td></tr> <tr><td>-33 .....</td><td>-X .....</td></tr> <tr><td>-35* .....</td><td>-Z .....</td></tr> <tr><td>-43 .....</td><td></td></tr> </table> <p>* Specify -31 or -33 Bucket      **88450 Provided</p>	LIST PRICE					PIPE SIZE	49520A	49520A -LF	49520A -NB	49520A -LF-NB	2" - 4"					-3 .....	-45 .....	-4 .....	-51 .....	-7 .....	-52 .....	-8 .....	-55** .....	-16 (ARE) .....	-C .....	-16 (NB) .....	-LF .....	-17 (ARE) .....	-LG (ARE) .....	-17 (NB) .....	-LG (NB) .....	-18 (ARE) .....	-NB .....	-18 (NB) .....	-TSI .....	-31 .....	-VP (NB) .....	-33 .....	-X .....	-35* .....	-Z .....	-43 .....									
LIST PRICE																																																																																													
PIPE SIZE	49400	49400 -LF	49400 -NB	49400 -LF-NB																																																																																									
2", 4", 6"																																																																																													
-3 .....	-43 .....																																																																																												
-4 .....	-45 .....																																																																																												
-7 .....	-55** .....																																																																																												
-16 (ARE) .....	-C .....																																																																																												
-16 (NB) .....	-LF .....																																																																																												
-17 (ARE) .....	-LG (ARE) .....																																																																																												
-17 (NB) .....	-LG (NB) .....																																																																																												
-18 (ARE) .....	-NB .....																																																																																												
-18 (NB) .....	-TSI† .....																																																																																												
-31 .....	-VP (NB) .....																																																																																												
-33 .....	-X .....																																																																																												
-35* .....	-Z (4" & 6") .....																																																																																												
LIST PRICE																																																																																													
PIPE SIZE	49520A	49520A -LF	49520A -NB	49520A -LF-NB																																																																																									
2" - 4"																																																																																													
-3 .....	-45 .....																																																																																												
-4 .....	-51 .....																																																																																												
-7 .....	-52 .....																																																																																												
-8 .....	-55** .....																																																																																												
-16 (ARE) .....	-C .....																																																																																												
-16 (NB) .....	-LF .....																																																																																												
-17 (ARE) .....	-LG (ARE) .....																																																																																												
-17 (NB) .....	-LG (NB) .....																																																																																												
-18 (ARE) .....	-NB .....																																																																																												
-18 (NB) .....	-TSI .....																																																																																												
-31 .....	-VP (NB) .....																																																																																												
-33 .....	-X .....																																																																																												
-35* .....	-Z .....																																																																																												
-43 .....																																																																																													

# SANITARY FLOOR SINKS



A WATTS Brand

**49580A**



**SUPER-FLO® 12" ROUND TOP, 8" DEEP**

LIST PRICE				
PIPE SIZE	49580A	49580A -LF	49580A -NB	49580A -LF-NB
2" - 4"				

ADD FOR OPTIONS:

-3 .....	-45 .....
-4 .....	-51 .....
-7 .....	-52 .....
-8 .....	-55** .....
-16 (ARE) .....	-C .....
-16 (NB) .....	-LF .....
-17 (ARE) .....	-LG (ARE) .....
-17 (NB) .....	-LG (NB) .....
-18 (ARE) .....	-NB .....
-18 (NB) .....	-TSI .....
-31 .....	-VP (NB) .....
-33 .....	-X .....
-35* .....	-Z .....
-43 .....	

\* Specify -31 or -33 Bucket  
\*\* 88450 Provided

**49850**



**12" ROUND FLUSHING RIM TOP**

LIST PRICE	
PIPE SIZE	49850
2", 3"* 4", 6"	

ADD FOR OPTIONS:

-13 .....	-C .....
-14 .....	-TSI† .....
-51 .....	-VP .....
-98 .....	-X .....
	-Z (6") .....

\*The 49852 and 49853 use a 49854 Body with a Reducing Coupling.  
†Available up to 4" only

**49700**



**4" x 8" RECTANGULAR TOP, 4" DEEP**

LIST PRICE				
PIPE SIZE	49700	49700 -LF	49700 -NB	49700 -LF-NB
2", 3"				

ADD FOR OPTIONS:

-3 .....	-52 .....
-4 .....	-55* .....
-7 .....	-C .....
-8 .....	-LF .....
-16 (ARE) .....	-LG (ARE) .....
-16 (NB) .....	-LG (NB) .....
-30 .....	-NB .....
-43 .....	-TSI .....
-45 .....	-VP (NB) .....
-51 .....	-X .....

\* 88450 Provided

**49870A**



**12" SQUARE CAN WASH DRAIN**

LIST PRICE	
PIPE SIZE	49870A
3", 4"	

ADD FOR OPTIONS:

-35 .....	-C .....
-51 .....	-TSI .....
-55* .....	-VP .....
-98 .....	-X .....
	-Z .....

\* 88450 Provided

**49720**



**6" x 12" RECTANGULAR TOP, 7" DEEP**

LIST PRICE				
PIPE SIZE	49720	49720 -LF	49720 -NB	49720 -LF-NB
3", 4", 6"				

ADD FOR OPTIONS:

-LF .....	-16 (NB) .....
-NB .....	-18 (ARE) .....
-LG (ARE) .....	-18 (NB) .....
-LG (NB) .....	-30 .....
-3 .....	-43 .....
-4 .....	-45 .....
-7 .....	-51 .....
-8 .....	-52 .....
-TSI† .....	-55* .....
-VP (NB) .....	-C .....
-16 (ARE) .....	-X .....

\* 88450 Provided 3" & 4". Body Primer Tapped for 6".  
† Available up to 4" only

## Option Descriptions

- C Clamp Device
- LF Less Flange
- LG Less Grate
- NB Nickel Bronze Traffic Top
- TSI Trap Seal Insert
- VP Secured Grate, Vandal-Proof Screws
- 3 1/2 Grate
- 4 3/4 Grate
- 7 Full Grate with 2-1/2" Center Opening
- 8 Stainless Steel Depressed Grate
- 13 One-Piece Satin Nikaloy Grate
- 14 Loose-Set Satin Nikaloy Grate
- 16 Grate with 4" Round Funnel
- 17 Grate with 6" Round Funnel
- 18 Grate with 9" x 3-1/2" Oval Funnel
- 30 Stainless Steel Sediment Bucket
- 31 Sediment Bucket (Aluminum)
- 33 Sediment Bucket (A.R. Finish)
- 35 Stainless Steel Mesh Bucket Liner
- 43 Internal Dome Strainer (A.R. Finish)
- 45 Less Internal Dome Strainer
- 51 Galvanized Cast Iron Inside and Outside
- 52 Painted Inside and Outside
- 55 1/2" Primer Tap or Adapter
- 98 Water Supply Control Box

## Outlets

- X Inside Caulk Outlet
- Z No-Hub Outlet







STAINLESS STEEL RETROFIT LINER				
NOM. PIPE SIZE	TOP SIZE	GRATE TYPE	BODY DEPTH	LIST PRICE
2"	8"	Reinforced Perforated	6"	
3"	8"	Reinforced Perforated	6"	
4"	8"	Reinforced Perforated	6"	
2"	12"	Reinforced Perforated	6"	
3"	12"	Reinforced Perforated	6"	
4"	12"	Reinforced Perforated	6"	
2"	12"	Reinforced Perforated	8"	
3"	12"	Reinforced Perforated	8"	
4"	12"	Reinforced Perforated	8"	
2"	12"	Reinforced Perforated	10"	
3"	12"	Reinforced Perforated	10"	
4"	12"	Reinforced Perforated	10"	
2"	16"	Reinforced Perforated	6"	
3"	16"	Reinforced Perforated	6"	
4"	16"	Reinforced Perforated	6"	
6"	16"	Reinforced Perforated	6"	
8"	16"	Reinforced Perforated	6"	
2"	16"	Reinforced Perforated	12"	
3"	16"	Reinforced Perforated	12"	
4"	16"	Reinforced Perforated	12"	
6"	16"	Reinforced Perforated	12"	
8"	16"	Reinforced Perforated	12"	

ADD FOR OPTIONS:

DESCRIPTION	LIST ADD	LIST ADD	LIST ADD	LIST ADD	LIST ADD	LIST ADD
BENT EDGE						
BENT EDGE - for 4" Pipe Size						
BENT EDGE - for 6" Pipe Size						
3/4 GRATE						
1/2 GRATE						
No Grate						
Anti-Slip Mesh Grate						
Perimeter Slot Plate Grate						
Ladder Grate						
Filter Basket						
Solid Bucket						
Secured Grate						
316L Stainless Steel						

For part numbers and pricing on Josam's Stainless Steel Retrofit Liners please refer to the Stainless Steel Drains Price Guide.



<b>58600</b> 	<b>WALL ACCESS COVER</b>				<b>58640</b> 	<b>WALL ACCESS COVER</b>			
	<b>LIST PRICE</b>					<b>LIST PRICE</b>			
	TYPE NO.	58604	58606	58608		TYPE NO.	58642	58644	58646
<b>ADD FOR OPTIONS:</b>					<b>ADD FOR OPTIONS:</b>				
	-17.....		-COT6.....			-2 (58642).....		-C03.....	
	-20*.....		-PLG1-1/2.....			-2 (58644).....		-C04.....	
	-31**.....		-PLG2.....			-2 (58646).....		-C06.....	
	-C02.....		-PLG2-1/2.....			-10.....		-COT2.....	
	-C03.....		-PLG3.....			-2-10.....		-COT3.....	
	-C04.....		-PLG3-1/2.....			-20*.....		-COT4.....	
	-C06.....		-PLG4.....			-31*.....		-COT6.....	
	-COT2.....		-PLG5.....			-C02.....		-VP.....	
	-COT3.....		-PLG6.....						
	-COT4.....		-VP.....						
	*Specify -PLG, -CO or -COT.					*Specify -CO or -COT.			
	**Specify -CO or -COT.								
<b>58610</b> 	<b>WALL OR FLOOR ACCESS COVER</b>				<b>Option Descriptions</b> -AE Adjustable Extension -ARE Acid-Resisting Epoxy -CFC Carpet Cleanout Flange Cover -CO2 No-Hub Cleanout, 2" -CO3 No-Hub Cleanout, 3" -CO4 No-Hub Cleanout, 4" -CO6 No-Hub Cleanout, 6" -COT2 No-Hub Cleanout Tee, 2" -COT3 No-Hub Cleanout Tee, 3" -COT4 No-Hub Cleanout Tee, 4" -COT6 No-Hub Cleanout Tee, 6" -DBC Debris Cover -DBCS Debris Cover Small -DBCL Debris Cover Large -F Flange Only -GC Gasket Cover -LT Less Top -PLG Bronze N.P.T. Plug (Specify Plug Size) -SS Stainless Steel Top -SS-SD Stainless Steel, Special Duty Top -SS-SQ Square Top, Stainless Steel -VP Secured Cover, Vandal-Proof Screws -WF Wide Flange (not available on CI) -1 Satin Finish Nikaloy Top -1-SD Special Duty Satin Finish Nikaloy Top -1-SQ Square Top, Satin Finish Nikaloy -1-12 Cover Recessed for Tile, Satin Finish Nikaloy -1-13 Terrazzo Tile Cover, Satin Finish Nikaloy -2 Satin Finish Bronze Top -2-SD Special Duty Satin Finish Bronze Top -2-SQ Square Top, Satin Finish Bronze -2-10 Satin Finish Bronze Scoriated Cover -2-12 Cover Recessed for Tile, Satin Finish Bronze -2-13 Terrazzo Tile Cover, Satin Finish Bronze -5 Ductile Iron Top -6 Square Top, Cast Iron -6-1 Square Top, Nikaloy -6-2 Square Top, Bronze -10 Scoriated Cover -11 Smooth Top -12 Cover Recessed for Tile -14 Carpet Cleanout Marker -19 Plug Tapped for Center Screw -20 Raised Head Bronze Plug -22 Taper Thread Bronze Plug -24 Spanner Wrench -31 Galvanized Cast Iron Parts -41 Clamp Ring and Flange  Outlets -X Inside Caulk Outlet -Y Hub Outlet w/Gasket 2" - 4" -Z No-Hub Outlet				
	<b>LIST PRICE</b>								
	TYPE NO.	58614	58616	58618					
<b>ADD FOR OPTIONS:</b>									
	-2 (58614).....		-C03.....						
	-2 (58616).....		-C04.....						
	-2 (58618).....		-C06.....						
	-10.....		-COT2.....						
	-14.....		-COT3.....						
	-20*.....		-COT4.....						
	-31*.....		-COT6.....						
	-C02.....		-VP.....						
	*Specify -CO or -COT.								
<b>58620</b> 	<b>WALL OR FLOOR ACCESS COVER</b>								
	<b>LIST PRICE</b>								
	TYPE NO.	58624	58626						
<b>ADD FOR OPTIONS:</b>									
	-2 (58624).....		-C03.....						
	-2 (58626).....		-C04.....						
	-10.....		-C06.....						
	-14.....		-COT2.....						
	-20*.....		-COT3.....						
	-31*.....		-COT4.....						
	-VP.....		-COT6.....						
	-C02.....								
	*Specify -CO or -COT.								
<b>58630</b> 	<b>WALL OR FLOOR ACCESS COVER</b>								
	<b>LIST PRICE</b>								
	TYPE NO.	58631	58632						
<b>ADD FOR OPTIONS:</b>									
	-2 (58631).....		-C06.....						
	-2 (58632).....		-COT2.....						
	-20*.....		-COT3.....						
	-31*.....		-COT4.....						
	-C02.....		-COT6.....						
	-C03.....		-VP.....						
	-C04.....								
	*Specify -CO or -COT.								

	<b>58650</b>			<b>STAINLESS STEEL WALL ACCESS COVER</b>		
	<b>LIST PRICE</b>					
	TYPE NO.	58656				
	ADD FOR OPTIONS:					
-20*	.....	-COT2	.....			
-31*	.....	-COT3	.....			
-C02	.....	-COT4	.....			
-C03	.....	-COT6	.....			
-C04	.....	-VP	.....			
-C06	.....					
*Specify -CO or -COT.						

	<b>58680</b>			<b>ACCESS COVER</b>		
	<b>LIST PRICE</b>					
	TYPE NO.	58680				
	ADD FOR OPTIONS:					
-1	.....	-ARE	.....			
-2	.....	-C02	.....			
-5	.....	-C03	.....			
-20*	.....	-C04	.....			
-26	.....	-C06	.....			
-31	.....	-VP	.....			
Special Wording on Cover, SAN. or STORM. Specify on Order .....						
*Specify -CO or -COT.						

	<b>58900</b>					<b>NO-HUB CLEANOUT FERRULE</b>				
	<b>LIST PRICE</b>									
	PIPE SIZE	2"	3"	4"	6"					
	ADD FOR OPTIONS:									
-19	.....	-31	.....							
-20	.....	-Z	.....							

	<b>58910</b>					<b>NO-HUB CLEANOUT TEE w/PLUG</b>				
	<b>LIST PRICE</b>									
	PIPE SIZE	2"	3"	4"	6"					
	ADD FOR OPTIONS:									
-19	.....	-31	.....							
-20	.....	-Z	.....							

### Cleanout Option Descriptions

-ARE	Acid-Resisting Epoxy
-CO2	No-Hub Cleanout, 2"
-CO3	No-Hub Cleanout, 3"
-CO4	No-Hub Cleanout, 4"
-CO6	No-Hub Cleanout, 6"
-COT2	No-Hub Cleanout Tee, 2"
-COT3	No-Hub Cleanout Tee, 3"
-COT4	No-Hub Cleanout Tee, 4"
-COT6	No-Hub Cleanout Tee, 6"
-PLG1-1/2	Bronze NPT Plug, 1-1/2"
-PLG2	Bronze NPT Plug, 2"
-PLG2-1/2	Bronze NPT Plug, 2-1/2"
-PLG3	Bronze NPT Plug, 3"
-PLG3-1/2	Bronze NPT Plug, 3-1/2"
-PLG4	Bronze NPT Plug, 4"
-PLG5	Bronze NPT Plug, 5"
-PLG6	Bronze NPT Plug, 6"
-SD	Special-Duty Top, Nikaloy
-SQ	Square Top
-VP	Secured Cover, Vandal-Proof Screws
-1	Satin Finish Nikaloy Top
-2	Satin Finish Bronze Top
-5	Ductile Iron Top
-10	Scoriated Cover
-14	Carpet Cleanout Marker
-17	Center Screw Longer than Standard
-19	Plug Tapped for Center Screw
-20	Raised Head Bronze Plug
-26	Gasketed Cover
-31	Galvanized Cast Iron Parts
Outlets	
-Z	No-Hub Outlet

<b>60100H</b> 	MANUAL CLEANING, ON-FLOOR TYPE														
	TYPE NO.	PIPE SIZE	FLOW RATE GPM	GR. CAP. LBS	LIST PRICE	FOR OPTIONS, ADD TO LIST PRICE									
						-40	-61	-ISI	-EXT 6"	Ea. Add'l Inch Ext.	-RT	-ET	-HD	-AC	
	60102H	2	7	14											
	60103H	2	10	20											
	60104H	2	15	30											
	60105H	3	20	40											
	60106H	3	25	50											
	60107H	3	35	70											
	60108H	3	50	100											
60109H	3	75	150												
60110H	4	100	200												
ADD FOR OPTIONS:															
-40 ..... -ET ..... -ISI ..... -61 ..... -EXT ..... -RT ..... -85 ..... -GRD ..... -SS ..... -AC ..... -HD .....															

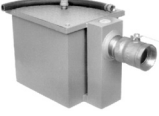
<b>60100-SA</b> 	SEMI-AUTOMATIC						
	TYPE NO.	PIPE SIZE	FLOW RATE GPM	GREASE CAP. LBS	LIST PRICE	FOR OPTIONS, ADD TO LIST PRICE	
						-RT	-ET
	60102-SA	2	7	14			
	60103-SA	2	10	20			
	60104-SA	2	15	30			
	60105-SA	2	20	40			
	60106-SA	3*	25	50			
	60107-SA	3*	35	70			
	60108-SA	3*	50	100			
60109-SA	3*	75	150				
ADD FOR OPTIONS:							
-62 ..... -66 ..... -85 ..... -65 ..... -67 ..... -ET ..... -RT .....							
*3" Sizes Normally Furnished with 4" x 3" Reducing Bushings.							



### Grease Interceptor Option Descriptions

- |      |  |     |  |
|------|--|-----|--|
| -ET  | Enclosed Type                                    | -40 | Cover Recess for Floor Finish                      |
| -EXT | Extension, 6" Standard, Specify Extension Height | -61 | Flange and Clamp Device                            |
| -AC  | Aluminum Cover                                   | -62 | 4" Inlet and Outlet Available on Standard 3" Sizes |
| -HD  | Heavy-Duty Cover                                 | -65 | Hub Inlet, Spigot Outlet, 2                        |
| -ISI | Integrated Solids Interceptor                    | -66 | Hub Inlet, Spigot Outlet, 3                        |
| -RT  | Recessed Type                                    | -67 | Hub Inlet, Spigot Outlet, 4"                       |
| -SS  | Stainless Steel                                  | -85 | Enzymatic Port                                     |

# GREASE INTERCEPTORS





A WATTS Brand

	MANUAL CLEANING, LOW TYPE						SEMI-AUTOMATIC, LOW TYPE				
	TYPE NO.	PIPE SIZE	FLOW RATE GPM	GREASE CAP. LBS.	LIST PRICE		TYPE NO.	PIPE SIZE	FLOW RATE GPM	GREASE CAP. LBS.	LIST PRICE
	60115A	2*	20	40			60115A-SA	3	35		
	60117A	3	35	70			ADD FOR OPTIONS:				
ADD FOR OPTIONS:											
-65..... -85.....											
-66.....											
-68.....											
*2" Sizes Normally Furnished with 3" x 2" Reducing Bushings											

	MANUAL CLEANING TYPE, HIGH VOLUME										
	TYPE NO.	PIPE SIZE	FLOW RATE GPM	GREASE CAP. LBS.	LIST PRICE	-EXT 6"	Ea. Add'l Inch Ext.	-60	-61	-ISI	-HD
	60213A	4	150	300							
	60214A	5	200	400							
	60215A	5	250	500							
	60216A	6	350	700							
60217A	6	500	1000								
ADD FOR OPTIONS:											
-60..... -85..... -HD.....											
-61..... -EXT..... -ISI.....											

## Grease Interceptor Option Descriptions

- |      |  |     |  |
|------|--|-----|--|
| -EXT | Extension, 6" Standard, Specify Extension Height | -62 | 4" Inlet and Outlet Available on Standard 3" Sizes |
| -HD  | Heavy-Duty Cover                                 | -65 | Hub Inlet, Spigot Outlet, 2                        |
| -ISI | Integrated Solids Interceptor                    | -66 | Hub Inlet, Spigot Outlet, 3                        |
| -60  | Anchor Flange                                    | -68 | 3" Inlet and Outlet Avail on Std 2" Sizes          |
| -61  | Flange and Clamp Device                          | -85 | Enzymatic Port                                     |

	<b>60500B</b>									
	<b>DRAW-OFF, GRAVITY TYPE</b>									
	TYPE NO.	PIPE SIZE	FLOW RATE GPM	LIST PRICE	FOR OPTIONS, ADD TO LIST PRICE					
					-EXT 6"	Ea. Add'l Inch Ext.	-60†	-61†	-HD	
	60503B	2	10							
	60504B	2	15							
	60505B	3*	20							
	60506B	3*	25							
	60507B	3*	35							
	60508B	3*	50							
ADD FOR OPTIONS:										
-60 ..... -EXT ..... -HD ..... -61 ..... * 3" Sizes Normally Furnished with 4" x 3" Reducing Bushings. †Only Available with -EXT Option										
	<b>60500-EST</b>									
	<b>DRAW-OFF, GRAVITY TYPE w/EXTERNAL STORAGE TANK</b>									
	TYPE NO.	PIPE SIZE	FLOW RATE GPM	TANK CAP. GAL.	LIST PRICE	FOR OPTIONS, ADD TO LIST PRICE				
						-EXT 6"	Ea. Add'l Inch Ext.	-60	-61	-HD
	60503-EST-5	2	10	5						
	60503-EST-50	2	10	50						
	60504-EST-6	2	15	6						
	60504-EST-50	2	15	50						
	60505-EST-8	3*	20	8						
	60505-EST-50	3*	20	50						
	60506-EST-50	3*	25	50						
	60506-EST-100	3*	25	100						
	60507-EST-50	3*	35	50						
	60507-EST-100	3*	35	100						
60508-EST-50	3*	50	50							
60508-EST-100	3*	50	100							
ADD FOR OPTIONS:										
-19 ..... -61 ..... -HD ..... -60† ..... -EXT ..... * 3" Sizes Normally Furnished with 4" x 3" Reducing Bushings. †Only Available with -EXT Option										
	<b>60610A</b>									
	<b>DRAW-OFF TYPE, HIGH VOLUME</b>									
	TYPE NO.	PIPE SIZE	FLOW RATE GPM	LIST PRICE	FOR OPTIONS, ADD TO LIST PRICE					
					-EXT 6"	Ea. Add'l Inch Ext.	-60*	-61*	-HD	
	60611A	3	75							
	60612A	4	100							
	60613A	4	150							
	60614A	5	200							
	60615A	5	250							
	60616A	6	350							
60617A	6	500								
ADD FOR OPTIONS:										
-60* ..... -EXT ..... -HD ..... -61* ..... * Only Available with -EXT Option										

### Oil Separator Option Descriptions

-EXT	Extension, 6" Standard, Specify Extension Height	-60	Anchor Flange
-HD	Heavy-Duty Cover	-61	Flange and Clamp Device
-19	Reclaim Tank Alarm		

# OIL, OIL/SEDIMENT & SOLIDS INTERCEPTORS



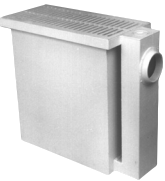

A WATTS Brand

 <p>EXTERNAL STORAGE TANK NOT SHOWN</p>	<b>DRAW-OFF, GRAVITY TYPE w/EXTERNAL STORAGE TANK</b>									
	TYPE NO.	PIPE SIZE	FLOW RATE GPM	TANK CAP. GAL	LIST PRICE	FOR OPTIONS, ADD TO LIST PRICE				
						-EXT 6"	Ea. Add'l Inch Ext.	-60*	-61*	-HD
	60611-EST	3	75	100						
	60612-EST	4	100	250						
	60613-EST	4	150	250						
	60614-EST	5	200	250						
	60615-EST	5	250	500						
	60616-EST	6	350	500						
	60617-EST	6	500	500						
ADD FOR OPTIONS:										
-19 ..... -61* ..... -HD .....										
-60 ..... -EXT .....										
* Only Available with -Ext Option										

	<b>OIL SEDIMENT INTERCEPTOR</b>		
	TYPE NO.	PIPE SIZE	LIST PRICE
	60816	2	
	60817	4	
	60818	4	
	60819	4	

	<b>SOLIDS INTERCEPTOR TOP ACCESS ON-FLOOR TRAP TYPE</b>		
	TYPE NO.	PIPE SIZE	LIST PRICE
	61042A	2	
	61043A	3	
	61044A	4	
	ADD FOR OPTIONS:		
-15 ..... -EXT* .....			
-16 .....			
*6" Standard, Each Add'l. Inch.....			



	<b>SOLIDS INTERCEPTOR BOTTOM ACCESS FIXTURE TRAP TYPE</b>			
	TYPE NO.	INLET	OUTLET	LIST PRICE
	61001-1/4	1-1/4	1-1/2	
	61001-1/2	1-1/2	1-1/2	
	ADD FOR OPTIONS:			
	-1 ..... -30 .....			
-3 ..... -CP .....				

	<b>SOLIDS INTERCEPTOR TOP ACCESS IN-LINE TYPE</b>		
	TYPE NO.	PIPE SIZE	LIST PRICE
	61072	2	
	61073	3	
	61074	4	
	ADD FOR OPTIONS:		
-4 ..... -86 .....			
-15 .....			

	<b>SOLIDS INTERCEPTOR CAST IRON TOP ACCESS FIXTURE TRAP TYPE</b>		
	TYPE NO.	PIPE SIZE	LIST PRICE
	61031-1/2-1	1-1/2	
	61032-1	2	
	ADD FOR OPTIONS:		
	-26 ..... -30 .....		



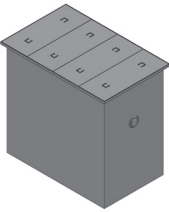
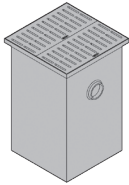
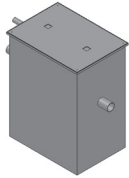
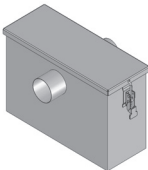
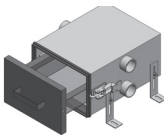
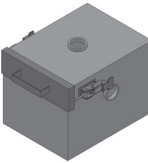



	<b>SOLIDS INTERCEPTOR TOP ACCESS IN-LINE TYPE</b>		
	TYPE NO.	PIPE SIZE	LIST PRICE
	61084	4	
	61085	5	
	61086	6	
	ADD FOR OPTIONS:		
-4 ..... -86 .....			
-15 .....			





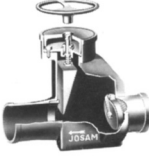

Oil & Solids Interceptor Option Descriptions			
-EXT	Extension, 6" Standard, Specify Extension Height	-16	Monel Screens
-HD	Heavy-Duty Cover	-19	Reclaim Tank Alarm
-CP	Chrome Plated Bronze	-26	Cast Aluminum
-1	Painted Cast Iron	-30	Acid-Resisting Cast Iron Inside and Outside
-3	Polished Bronze	-60	Anchor Flange
-4	Galvanized Cast Iron Parts	-61	Flange and Clamp Device
-15	Stainless Steel Basket	-86	Flat Bottom Basket

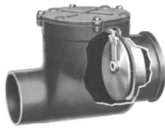
	<b>SAND INTERCEPTOR</b>															
	TYPE NO.		CAPACITY CUBIC FT.		SIZE GALLONS		LIST PRICE		FOR OPTIONS, ADD TO LIST PRICE							
									-EXT UP TO 6"	-HD						
	61091		45		340											
	61092		54		400											
	61093		72		540											
	61094		81		610											
61095		90		670												
61096		108		810												
61097		135		1,010												
ADD FOR OPTIONS:																
-EXT ..... -HD .....																
	<b>SAND/SEDIMENT INTERCEPTOR</b>															
	TYPE NO.		PIPE SIZE		FLOW RATE GPM		# OF GRATES		LIST PRICE		FOR OPTIONS, ADD TO LIST PRICE					
											-EXT 6"	Each Add'l Inch Ext.	-HD	-61	-7	-17-H20
	61103		4		20		2									
	61104		4		50		4									
	61105		4		150		8									
	61106		6		250		12									
61107		8		500		20										
ADD FOR OPTIONS:																
-61 ..... -EXT ..... -HD .....																
	<b>RICE INTERCEPTOR</b>					<b>SOLIDS INTERCEPTOR IN-LINE TYPE</b>										
	TYPE NO.		PIPE SIZE			LIST PRICE		TYPE NO.		PIPE SIZE		FLOW RATE GPM		LIST PRICE		
	61202		3					61303		3		50				
	61203		4					61304		4		100				
	61204		4													
	61205		4													
	61207		6													
ADD FOR OPTIONS:																
-SS ..... -T .....																
	<b>SOLIDS INTERCEPTOR DRAWER TYPE, SIDE INLET</b>					<b>SOLIDS INTERCEPTOR DRAWER TYPE, TOP INLET</b>										
	TYPE NO.		PIPE SIZE			LIST PRICE		TYPE NO.		PIPE SIZE		LIST PRICE				
	61402		2					61502		2						
	ADD FOR OPTIONS:															
-316 ..... -T .....																
	<b>LINT INTERCEPTOR</b>															
	TYPE NO.		PIPE SIZE		FLOW RATE GPM		MAX. NUMBER OF WASHERS		LIST PRICE		FOR OPTIONS, ADD TO LIST PRICE					
											-EXT 6"	Ea. Add'l Inch Ext.				
	61805		3		70		7									
	61806		4		200		20									
	61807		6		300		30									
61808		6		400		40										

### Interceptors Option Descriptions

-316	Type 316 L Stainless Steel	-EXT	Extension, 6" Standard, Specify Extension Height
-61	Flange and Clamp Device	-HD	Heavy-Duty Cover
-7	Ductile Iron Grates	-SS	Stainless Steel
-17-H20	Ductile Iron Grates with Additional Welded Supports	-T	NPT Threaded Connections

<p><b>67100A</b></p> 	<p><b>BALL-FLOAT ADAPTER TYPE</b></p> <table border="1"> <thead> <tr> <th colspan="3">LIST PRICE</th> </tr> <tr> <th>PIPE SIZE</th> <th>2", 3", 4"</th> <th>6"</th> </tr> </thead> <tbody> <tr> <td></td> <td></td> <td></td> </tr> </tbody> </table> <p>ADD FOR OPTIONS:</p> <p>-5 (2" - 4") ..... -35.....</p> <p>-5 (6") .....</p>	LIST PRICE			PIPE SIZE	2", 3", 4"	6"				<p><b>67650</b></p> 	<p><b>COMBINED DRAIN/SWING-CHECK TYPE</b></p> <table border="1"> <thead> <tr> <th colspan="3">LIST PRICE</th> </tr> <tr> <th>PIPE SIZE</th> <th>3", 4"</th> <th>6"</th> </tr> </thead> <tbody> <tr> <td></td> <td></td> <td></td> </tr> </tbody> </table> <p>ADD FOR OPTIONS:</p> <p>-1 (3", 4") ..... -25.....</p> <p>-1 (6") ..... -LBV (3", 4").....</p> <p>-2 (3", 4") ..... -LBV (6").....</p> <p>-2 (6") ..... -VP.....</p> <p>-5.....</p>	LIST PRICE			PIPE SIZE	3", 4"	6"									
LIST PRICE																											
PIPE SIZE	2", 3", 4"	6"																									
LIST PRICE																											
PIPE SIZE	3", 4"	6"																									
<p><b>67360</b></p> 	<p><b>SHEAR-GATE &amp; SWING-CHECK TYPE</b></p> <table border="1"> <thead> <tr> <th colspan="3">LIST PRICE</th> </tr> <tr> <th>PIPE SIZE</th> <th>67360</th> <th>67360-DH</th> </tr> </thead> <tbody> <tr> <td>3", 4"</td> <td></td> <td></td> </tr> <tr> <td>5", 6"</td> <td></td> <td></td> </tr> </tbody> </table> <p>ADD FOR OPTIONS:</p> <p>-15.....</p> <p>-28 (3", 4") ..... -29 (3", 4").....</p> <p>-28 (3", 4") ..... -29 (5", 6").....</p> <p>-28 (5", 6") ..... -DH.....</p>	LIST PRICE			PIPE SIZE	67360	67360-DH	3", 4"			5", 6"			<p><b>67720</b></p> 	<p><b>HUB INLET, SWING-CHECK TYPE</b></p> <table border="1"> <thead> <tr> <th colspan="3">LIST PRICE</th> </tr> <tr> <th>PIPE SIZE</th> <th>3"</th> <th>4"</th> </tr> </thead> <tbody> <tr> <td></td> <td></td> <td></td> </tr> </tbody> </table> <p>ADD FOR OPTIONS:</p> <p>-15.....</p>	LIST PRICE			PIPE SIZE	3"	4"						
LIST PRICE																											
PIPE SIZE	67360	67360-DH																									
3", 4"																											
5", 6"																											
LIST PRICE																											
PIPE SIZE	3"	4"																									
<p><b>67400</b></p> 	<p><b>NO-HUB SWING-CHECK TYPE</b></p> <table border="1"> <thead> <tr> <th colspan="5">LIST PRICE</th> </tr> <tr> <th>PIPE SIZE</th> <th>2"</th> <th>3"</th> <th>4"</th> <th>6"</th> </tr> </thead> <tbody> <tr> <td></td> <td></td> <td></td> <td></td> <td></td> </tr> </tbody> </table>	LIST PRICE					PIPE SIZE	2"	3"	4"	6"						<p><b>67800</b></p> 	<p><b>HUB INLET, SWING-CHECK TYPE</b></p> <table border="1"> <thead> <tr> <th colspan="3">LIST PRICE</th> </tr> <tr> <th>PIPE SIZE</th> <th>6"</th> <th>8"</th> </tr> </thead> <tbody> <tr> <td></td> <td></td> <td></td> </tr> </tbody> </table> <p>ADD FOR OPTIONS:</p> <p>-4..... -15.....</p>	LIST PRICE			PIPE SIZE	6"	8"			
LIST PRICE																											
PIPE SIZE	2"	3"	4"	6"																							
LIST PRICE																											
PIPE SIZE	6"	8"																									
<p><b>67500</b></p> 	<p><b>HUB &amp; SPIGOT SWING-CHECK TYPE</b></p> <table border="1"> <thead> <tr> <th colspan="4">LIST PRICE</th> </tr> <tr> <th>PIPE SIZE</th> <th>2"</th> <th>3"</th> <th>4"</th> </tr> </thead> <tbody> <tr> <td></td> <td></td> <td></td> <td></td> </tr> <tr> <th>PIPE SIZE</th> <th>6"</th> <th>8"</th> <td></td> </tr> <tr> <td></td> <td></td> <td></td> <td></td> </tr> </tbody> </table> <p>ADD FOR OPTIONS:</p> <p>-5 (2" - 4") ..... -15.....</p> <p>-5 (6" - 8") ..... -30.....</p> <p>-10*.....</p> <p>* For Extension, Use -10 Option with Hub and Spigot Extension Pipe by Others.</p>	LIST PRICE				PIPE SIZE	2"	3"	4"					PIPE SIZE	6"	8"						<p><b>Backwater Valve Option Descriptions</b></p> <ul style="list-style-type: none"> <li>-DH Double Hub</li> <li>-LBV Less Backwater Valve</li> <li>-VP Secured Face, Vandal-Proof Screws</li> <li>-1 Satin Finish Nikaloy Face</li> <li>-2 Satin Finish Bronze Face</li> <li>-4 Bronze Seat</li> <li>-5 Galvanized Cast Iron Parts</li> <li>-10 Threaded Bronze Cover</li> <li>-15 Open Flap</li> <li>-25 Flashing Clamp Device</li> <li>-28 12" Cast Iron Extension and Stem</li> <li>-29 24" Cast Iron Extension and Stem</li> <li>-30 2" Auxiliary Inlet with Bronze Plug</li> <li>-35 1/2" Primer Tap</li> </ul>					
LIST PRICE																											
PIPE SIZE	2"	3"	4"																								
PIPE SIZE	6"	8"																									
<p><b>67600</b></p> 	<p><b>HUB &amp; SPIGOT SWING-CHECK TYPE</b></p> <table border="1"> <thead> <tr> <th colspan="3">LIST PRICE</th> </tr> <tr> <th>TYPE NO.</th> <th>PIPE SIZE</th> <td></td> </tr> </thead> <tbody> <tr> <td>67610</td> <td>10"</td> <td></td> </tr> <tr> <td>67612</td> <td>12"</td> <td></td> </tr> </tbody> </table> <p>ADD FOR OPTIONS:</p> <p>-15.....</p>	LIST PRICE			TYPE NO.	PIPE SIZE		67610	10"		67612	12"															
LIST PRICE																											
TYPE NO.	PIPE SIZE																										
67610	10"																										
67612	12"																										

<p><b>71300</b></p> 	<p><b>QUARTER-TURN HYDRANT, BOX TYPE FOR NSF/ANSI 61</b></p> <table border="1"> <thead> <tr> <th colspan="2">LIST PRICE</th> </tr> <tr> <th>SIZE</th> <th></th> </tr> </thead> <tbody> <tr> <td>6-1/4</td> <td>71300-6-QTR</td> </tr> <tr> <td>7-1/4</td> <td>71300-7-QTR</td> </tr> <tr> <td>9-1/4</td> <td>71300-9-QTR</td> </tr> <tr> <td>11-1/4</td> <td>71300-11-QTR</td> </tr> <tr> <td>13-1/4</td> <td>71300-13-QTR</td> </tr> <tr> <td>15-1/4</td> <td>71300-15-QTR</td> </tr> <tr> <td>17-1/4</td> <td>71300-17-QTR</td> </tr> </tbody> </table> <p><b>ADD FOR OPTIONS:</b></p> <table border="1"> <tr> <td>-52*</td> <td>-91 .....</td> </tr> <tr> <td>-54*</td> <td>-95 .....</td> </tr> <tr> <td>-72 .....</td> <td>-HD .....</td> </tr> <tr> <td>-74 .....</td> <td>-HD-52 .....</td> </tr> <tr> <td>-81 .....</td> <td>-HD-54 .....</td> </tr> </table> <p>*SS Box Body</p>	LIST PRICE		SIZE		6-1/4	71300-6-QTR	7-1/4	71300-7-QTR	9-1/4	71300-9-QTR	11-1/4	71300-11-QTR	13-1/4	71300-13-QTR	15-1/4	71300-15-QTR	17-1/4	71300-17-QTR	-52*	-91 .....	-54*	-95 .....	-72 .....	-HD .....	-74 .....	-HD-52 .....	-81 .....	-HD-54 .....	<p><b>71600</b></p> 	<p><b>YARD HYDRANT, BOX TYPE NON-FREEZE</b></p> <table border="1"> <thead> <tr> <th colspan="3">LIST PRICE</th> </tr> <tr> <th>SIZE</th> <th>71600 3/4" Connection</th> <th>71600-91 1" Connection</th> </tr> </thead> <tbody> <tr> <td>2' Bury</td> <td></td> <td></td> </tr> <tr> <td>3' Bury</td> <td></td> <td></td> </tr> <tr> <td>4' Bury</td> <td></td> <td></td> </tr> <tr> <td>5' Bury</td> <td></td> <td></td> </tr> </tbody> </table> <p><b>ADD FOR OPTIONS:</b></p> <table border="1"> <tr> <td>-52 .....</td> <td>-91 .....</td> </tr> <tr> <td>-80 .....</td> <td>-95 .....</td> </tr> <tr> <td>-81* .....</td> <td>-97 .....</td> </tr> </table> <p>*Requires -80</p>	LIST PRICE			SIZE	71600 3/4" Connection	71600-91 1" Connection	2' Bury			3' Bury			4' Bury			5' Bury			-52 .....	-91 .....	-80 .....	-95 .....	-81* .....	-97 .....
LIST PRICE																																																							
SIZE																																																							
6-1/4	71300-6-QTR																																																						
7-1/4	71300-7-QTR																																																						
9-1/4	71300-9-QTR																																																						
11-1/4	71300-11-QTR																																																						
13-1/4	71300-13-QTR																																																						
15-1/4	71300-15-QTR																																																						
17-1/4	71300-17-QTR																																																						
-52*	-91 .....																																																						
-54*	-95 .....																																																						
-72 .....	-HD .....																																																						
-74 .....	-HD-52 .....																																																						
-81 .....	-HD-54 .....																																																						
LIST PRICE																																																							
SIZE	71600 3/4" Connection	71600-91 1" Connection																																																					
2' Bury																																																							
3' Bury																																																							
4' Bury																																																							
5' Bury																																																							
-52 .....	-91 .....																																																						
-80 .....	-95 .....																																																						
-81* .....	-97 .....																																																						
<p><b>71350</b></p> 	<p><b>QUARTER-TURN HYDRANT FOR NSF/ANSI 61</b></p> <table border="1"> <thead> <tr> <th colspan="2">LIST PRICE</th> </tr> <tr> <th>SIZE</th> <th></th> </tr> </thead> <tbody> <tr> <td>3</td> <td>71350-MC-QTR</td> </tr> <tr> <td>4</td> <td>71350-4-QTR</td> </tr> <tr> <td>6</td> <td>71350-6-QTR</td> </tr> <tr> <td>8</td> <td>71350-8-QTR</td> </tr> <tr> <td>10</td> <td>71350-10-QTR</td> </tr> <tr> <td>12</td> <td>71350-12-QTR</td> </tr> <tr> <td>14</td> <td>71350-14-QTR</td> </tr> </tbody> </table> <p><b>ADD FOR OPTIONS:</b></p> <table border="1"> <tr> <td>-72 .....</td> <td>-91 .....</td> </tr> <tr> <td>-74 .....</td> <td></td> </tr> <tr> <td>-EPCP .....</td> <td></td> </tr> <tr> <td>-81 .....</td> <td></td> </tr> </table>	LIST PRICE		SIZE		3	71350-MC-QTR	4	71350-4-QTR	6	71350-6-QTR	8	71350-8-QTR	10	71350-10-QTR	12	71350-12-QTR	14	71350-14-QTR	-72 .....	-91 .....	-74 .....		-EPCP .....		-81 .....		<p><b>71650</b></p> 	<p><b>TRI-TEMP WALL HYDRANT, BOX TYPE NON-FREEZE</b></p> <table border="1"> <thead> <tr> <th colspan="3">LIST PRICE</th> </tr> <tr> <th>SIZE</th> <th>71650 3/4" Connection</th> <th>71650-91 1" Connection</th> </tr> </thead> <tbody> <tr> <td>6", 8" Wall</td> <td></td> <td></td> </tr> <tr> <td>10", 12", 14" Wall</td> <td></td> <td></td> </tr> <tr> <td>16", 18" Wall</td> <td></td> <td></td> </tr> <tr> <td>20", 22", 24" Wall</td> <td></td> <td></td> </tr> </tbody> </table> <p><b>ADD FOR OPTIONS:</b></p> <table border="1"> <tr> <td>-72 .....</td> <td>-81 .....</td> </tr> <tr> <td>-73 .....</td> <td>-91 .....</td> </tr> <tr> <td>-74 .....</td> <td>-95 .....</td> </tr> </table>	LIST PRICE			SIZE	71650 3/4" Connection	71650-91 1" Connection	6", 8" Wall			10", 12", 14" Wall			16", 18" Wall			20", 22", 24" Wall			-72 .....	-81 .....	-73 .....	-91 .....	-74 .....	-95 .....		
LIST PRICE																																																							
SIZE																																																							
3	71350-MC-QTR																																																						
4	71350-4-QTR																																																						
6	71350-6-QTR																																																						
8	71350-8-QTR																																																						
10	71350-10-QTR																																																						
12	71350-12-QTR																																																						
14	71350-14-QTR																																																						
-72 .....	-91 .....																																																						
-74 .....																																																							
-EPCP .....																																																							
-81 .....																																																							
LIST PRICE																																																							
SIZE	71650 3/4" Connection	71650-91 1" Connection																																																					
6", 8" Wall																																																							
10", 12", 14" Wall																																																							
16", 18" Wall																																																							
20", 22", 24" Wall																																																							
-72 .....	-81 .....																																																						
-73 .....	-91 .....																																																						
-74 .....	-95 .....																																																						
<p><b>71400</b></p> 	<p><b>YARD HYDRANT NON-FREEZE</b></p> <table border="1"> <thead> <tr> <th colspan="2">LIST PRICE</th> </tr> <tr> <th>SIZE</th> <th>3/4" CONNECTION</th> </tr> </thead> <tbody> <tr> <td>2' Bury</td> <td></td> </tr> <tr> <td>3' Bury</td> <td></td> </tr> <tr> <td>4' Bury</td> <td></td> </tr> <tr> <td>5' Bury</td> <td></td> </tr> <tr> <td>6' Bury</td> <td></td> </tr> </tbody> </table>	LIST PRICE		SIZE	3/4" CONNECTION	2' Bury		3' Bury		4' Bury		5' Bury		6' Bury		<p><b>Hydrant Option Descriptions</b></p> <ul style="list-style-type: none"> <li>-52 Satin Finish Bronze Face, SS Box</li> <li>-54 Satin Finish Nikaloy Face, SS Box</li> <li>-72 Wall Clamp</li> <li>-73 Solder Inlet Adapter</li> <li>-74 Union Elbow Assembly</li> <li>-80 Deep Box</li> <li>-81 Vacuum Breaker</li> <li>-91 1" Hose Pipe Threaded Outlet</li> <li>-95 Cylinder Vandal-Proof Lock</li> <li>-97 1/8" Tapped Drain Hole in Box</li> <li>-EPCP Escutcheon Plate, Chrome-Plated</li> <li>-HD Heavy Duty</li> <li>-HD-52 Heavy Duty Box, Satin Finish Bronze Face</li> <li>-HD-54 Heavy Duty Box, Satin Finish Nikaloy Face</li> </ul>																																							
LIST PRICE																																																							
SIZE	3/4" CONNECTION																																																						
2' Bury																																																							
3' Bury																																																							
4' Bury																																																							
5' Bury																																																							
6' Bury																																																							
<p><b>71450</b></p> 	<p><b>YARD HYDRANT, HEAVY-DUTY NON-FREEZE</b></p> <table border="1"> <thead> <tr> <th colspan="3">LIST PRICE</th> </tr> <tr> <th>SIZE</th> <th>71450 3/4" Connection</th> <th>71450 1" Connection</th> </tr> </thead> <tbody> <tr> <td>2' Bury</td> <td></td> <td></td> </tr> <tr> <td>3' Bury</td> <td></td> <td></td> </tr> <tr> <td>4' Bury</td> <td></td> <td></td> </tr> <tr> <td>5' Bury</td> <td></td> <td></td> </tr> <tr> <td>6' Bury</td> <td></td> <td></td> </tr> </tbody> </table>	LIST PRICE			SIZE	71450 3/4" Connection	71450 1" Connection	2' Bury			3' Bury			4' Bury			5' Bury			6' Bury																																			
LIST PRICE																																																							
SIZE	71450 3/4" Connection	71450 1" Connection																																																					
2' Bury																																																							
3' Bury																																																							
4' Bury																																																							
5' Bury																																																							
6' Bury																																																							

**SHOCK ABSORBERS**

<p><b>75000</b></p>	<p><b>STAINLESS STEEL SHELL &amp; ADAPTER</b></p>
<p><b>LIST PRICE</b></p>	
<p>SIZE</p>	
<p>A B C D E F</p>	

**TRENCH DRAINS**

<p><b>76000</b></p>	<p><b>SUPER-FLO® 6" WIDE, RECTANGULAR</b></p>	<p><b>76010</b></p>	<p><b>12" WIDE, RECTANGULAR</b></p>
<p><b>LIST PRICE</b></p>		<p><b>LIST PRICE</b></p>	
<p>PIPE SIZE    2", 3", 4"</p>		<p>PIPE SIZE    3" - 6"</p>	
<p>ADD FOR OPTIONS:</p>		<p>ADD FOR OPTIONS:</p>	
<p>-1 ..... -ARE..... -2 ..... -EXT..... -7 ..... -VP..... -30..... -X..... -40.....</p>		<p>-1 ..... -70..... -2 ..... -70-40..... -7 ..... -ARE..... -11 ..... -EXT..... -30 ..... -VP..... -40 ..... -X.....</p>	
<p>2" and 3" Provided as 4" -X with Reducer.</p>		<p>3" Provided as 4" -X with Reducer.</p>	

<p><b>76200</b></p>	<p><b>FRAME &amp; GRATE ASSEMBLY (C CLASS)</b></p>		
<p>TYPE NO.</p>		<p>OVERALL WIDTH</p>	<p>LIST PRICE</p>
<p>76210 76220</p>		<p>6" 10"</p>	
<p>• PRICE ON APPLICATION</p>			

<p><b>76300</b> <b>76400</b></p>	<p><b>LIGHT-DUTY RECTANGULAR TRENCH DRAIN &amp; ADDITIONAL SECTIONS</b></p>					
<p><b>LIST PRICE</b></p>						
<p>OPTIONS</p>	<p>76300 20" GRATE</p>	<p>76301 SINGLE GRATE &amp; FRAME</p>	<p>76302 2-GRATE SECTION</p>	<p>76302 ADD'L. 20" 1-GRATE SECTION</p>	<p>76402 24" 2-GRATE SECTION</p>	<p>7640 ADD'L. 12" SECTIONS</p>
<p>ADD FOR OPTIONS:</p>						
<p>-1 -7 -8-2 -40 -VP</p>						

<p><b>76500</b> <b>76600</b></p>	<p><b>MEDIUM-DUTY RECTANGULAR TRENCH DRAIN &amp; ADDITIONAL SECTIONS</b></p>					
<p><b>LIST PRICE</b></p>						
<p>OPTIONS</p>	<p>76500 24" GRATE</p>	<p>76501 SINGLE GRATE &amp; FRAME</p>	<p>76502 2-GRATE SECTION</p>	<p>76502 ADD'L. 24" 1-GRATE SECTION</p>	<p>76602 24" 2-GRATE SECTION</p>	<p>7660 ADD'L. 12" SECTIONS</p>
<p>ADD FOR OPTIONS:</p>						
<p>-1 -7 -8-2 -40 -VP</p>						

**TRENCH DRAINS (cont'd)**

76700  
76800



**HEAVY-DUTY RECTANGULAR TRENCH DRAIN & ADDITIONAL SECTIONS**

LIST PRICE						
OPTIONS	76700 24" GRATE	76701 SINGLE GRATE & FRAME	76702 2-GRATE SECTION	76702 ADD'L. 24" 1-GRATE SECTION	76802 24" 2-GRATE SECTION	7680 ADD'L. 12" SECTIONS
ADD FOR OPTIONS:						
-1						
-7						
-8-2						
-40						
-VP						

**Trench Drain Option Descriptions**

- ARE Acid Resistant Coating on Cast Iron Parts
- EXT Extension Section
- VP \* Secured Grate, Vandal-Proof Screws
- 1 Satin Finish Nikaloy Top
- 2 Satin Finish Bronze Top
- 7 Ductile Iron Grate
- 8-2 All Bronze with Satin Finish Top
- 11 Convex Grate
- 30 Flashing Clamp Device
- 40 Galvanized Cast Iron Parts
- 70 Sediment Bucket
- 70-40 Sediment Bucket, Galvanized
- Outlet
- X Inside Caulk Outlet

\* For Installations Exposed to Vehicular Traffic, Specify -VP, Secured Grate

**MISCELLANEOUS PRODUCTS**

85220



**5" x 7" 90° ANGLE STRAINER**

LIST PRICE		
PIPE SIZE	2", 3", 4"	
ADD FOR OPTIONS:		
-3 .....	-47 .....	
-41 .....	-T .....	
-42 .....	-VP .....	

85810



**RECTANGULAR PATTERN DRAIN**

LIST PRICE		
PIPE SIZE	2", 3", 4"	
ADD FOR OPTIONS:		
-1 .....	-T .....	
-2 .....	-TSI .....	
-3 .....	-VP .....	
-42 .....	-X .....	
-47 .....		

85800



**RECTANGULAR PATTERN DRAIN**

LIST PRICE		
PIPE SIZE	4", 5", 6"	
ADD FOR OPTIONS:		
-1 .....	-47 .....	
-2 .....	-T .....	
-3 .....	-TSI .....	
-42 .....	-VP .....	

85903-Z













**CAST IRON DRAIN  
w/MEDIUM-DUTY SLOTTED GRATE**







LIST PRICE		
PIPE SIZE	3"	
ADD FOR OPTIONS:		
-47 .....	-TSI .....	
-F4-93 .....	-Z .....	

**Miscellaneous Product Option Descriptions**

- F4-93 Round Cast Iron Funnel
- TSI Trap Seal Insert
- VP Secured Grate, Vandal-Proof Screws
- 1 Satin Finish Nikaloy Top
- 2 Satin Finish Bronze Top
- 3 Chrome Plated Bronze Face
- 41 Clamp Device
- 42 Ground Screw
- 47 Galvanized Cast Iron Parts
- Outlets
- T Threaded Outlet
- X Inside Caulk Outlet
- Z No-Hub Outlet

# TRAPS & ACCESSORIES









<b>F52 &amp; F53</b> 	<b>CAST IRON THREADED FUNNEL</b> <table border="1"> <thead> <tr> <th colspan="2">LIST PRICE</th> </tr> </thead> <tbody> <tr> <td>F52</td> <td>F53</td> </tr> </tbody> </table>	LIST PRICE		F52	F53	<b>88270</b> 	<b>PLASTIC PIPE SLEEVE</b> <table border="1"> <thead> <tr> <th colspan="3">LIST PRICE</th> </tr> <tr> <th>MODEL</th> <th>SLEEVE SIZE</th> <th></th> </tr> </thead> <tbody> <tr> <td>88273</td> <td>3"</td> <td></td> </tr> <tr> <td>88274</td> <td>4"</td> <td></td> </tr> <tr> <td>88276</td> <td>6"</td> <td></td> </tr> <tr> <td>88278</td> <td>8"</td> <td></td> </tr> </tbody> </table>	LIST PRICE			MODEL	SLEEVE SIZE		88273	3"		88274	4"		88276	6"		88278	8"						
LIST PRICE																														
F52	F53																													
LIST PRICE																														
MODEL	SLEEVE SIZE																													
88273	3"																													
88274	4"																													
88276	6"																													
88278	8"																													
<b>88100</b> 	<b>P TRAP</b> <table border="1"> <thead> <tr> <th colspan="2">LIST PRICE</th> </tr> </thead> <tbody> <tr> <th>PIPE SIZE</th> <th></th> </tr> <tr> <td>2"</td> <td></td> </tr> <tr> <td>3"</td> <td></td> </tr> <tr> <td>4"</td> <td></td> </tr> </tbody> </table> <p>ADD FOR OPTIONS:</p> <p>-51 ..... -60 .....</p>	LIST PRICE		PIPE SIZE		2"		3"		4"		<b>88300</b> 	<b>TRAP SEAL PRIMER VALVE</b> <table border="1"> <thead> <tr> <th colspan="2">LIST PRICE</th> </tr> </thead> <tbody> <tr> <td>88300</td> <td></td> </tr> </tbody> </table> <p>88280 Less Distribution Unit.....</p>	LIST PRICE		88300														
LIST PRICE																														
PIPE SIZE																														
2"																														
3"																														
4"																														
LIST PRICE																														
88300																														
<b>88210</b> 	<b>DEEP SEAL TRAP, FUNNEL INLET</b> <table border="1"> <thead> <tr> <th colspan="2">LIST PRICE</th> </tr> </thead> <tbody> <tr> <th>PIPE SIZE</th> <th></th> </tr> <tr> <td>2"</td> <td></td> </tr> <tr> <td>3"</td> <td></td> </tr> </tbody> </table> <p>ADD FOR OPTIONS:</p> <p>-8 (2") ..... -51 .....</p> <p>-8 (3") ..... -72 .....</p> <p>-ARE.....</p>	LIST PRICE		PIPE SIZE		2"		3"		<b>88400</b> 	<b>NO-HUB SPIGOT ADAPTER</b> <table border="1"> <thead> <tr> <th colspan="2">LIST PRICE</th> </tr> </thead> <tbody> <tr> <th>PIPE SIZE</th> <th></th> </tr> <tr> <td>2"</td> <td></td> </tr> <tr> <td>3"</td> <td></td> </tr> <tr> <td>4"</td> <td></td> </tr> <tr> <td>6"</td> <td></td> </tr> <tr> <td>8"</td> <td></td> </tr> </tbody> </table> <p>ADD FOR OPTIONS:</p> <p>-40 ..... -50 .....</p> <p>-49 .....</p>	LIST PRICE		PIPE SIZE		2"		3"		4"		6"		8"						
LIST PRICE																														
PIPE SIZE																														
2"																														
3"																														
LIST PRICE																														
PIPE SIZE																														
2"																														
3"																														
4"																														
6"																														
8"																														
<b>88240</b> 	<b>TSI® - TRAP SEAL INSERT</b> <table border="1"> <thead> <tr> <th colspan="3">LIST PRICE</th> </tr> <tr> <th>MODEL</th> <th>PIPE SIZE</th> <th></th> </tr> </thead> <tbody> <tr> <td>88242</td> <td>2"</td> <td></td> </tr> <tr> <td>88243</td> <td>3"</td> <td></td> </tr> <tr> <td>88243-1/2</td> <td>3-1/2"</td> <td></td> </tr> <tr> <td>88244</td> <td>4"</td> <td></td> </tr> </tbody> </table>	LIST PRICE			MODEL	PIPE SIZE		88242	2"		88243	3"		88243-1/2	3-1/2"		88244	4"		<b>88450</b> 	<b>TRAP PRIMER ADAPTER</b> <table border="1"> <thead> <tr> <th colspan="3">LIST PRICE</th> </tr> <tr> <th>PIPE SIZE</th> <th>2", 3", 4"</th> <th></th> </tr> </thead> <tbody> <tr> <td></td> <td></td> <td></td> </tr> </tbody> </table>	LIST PRICE			PIPE SIZE	2", 3", 4"				
LIST PRICE																														
MODEL	PIPE SIZE																													
88242	2"																													
88243	3"																													
88243-1/2	3-1/2"																													
88244	4"																													
LIST PRICE																														
PIPE SIZE	2", 3", 4"																													
<b>88250</b> 	<b>TRAP SEAL PRIMER VALVE</b> <table border="1"> <thead> <tr> <th colspan="2">LIST PRICE</th> </tr> </thead> <tbody> <tr> <td>88250</td> <td></td> </tr> </tbody> </table> <p>ADD FOR OPTIONS:</p> <p>-10 .....</p>	LIST PRICE		88250		<b>88550</b> 	<b>HUB ADAPTER, THREADED OUTLET</b> <table border="1"> <thead> <tr> <th colspan="2">LIST PRICE</th> </tr> </thead> <tbody> <tr> <th>PIPE SIZE</th> <th></th> </tr> <tr> <td>3"</td> <td></td> </tr> <tr> <td>4"</td> <td></td> </tr> <tr> <td>5"</td> <td></td> </tr> <tr> <td>6"</td> <td></td> </tr> </tbody> </table> <p>ADD FOR OPTIONS:</p> <p>-40 (3", 4") ..... -40 (6") .....</p> <p>-40 (5") .....</p>	LIST PRICE		PIPE SIZE		3"		4"		5"		6"												
LIST PRICE																														
88250																														
LIST PRICE																														
PIPE SIZE																														
3"																														
4"																														
5"																														
6"																														

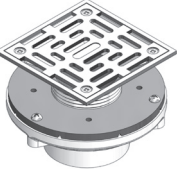

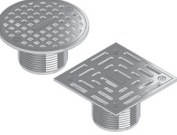

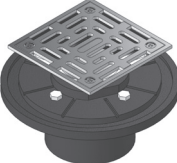
<p><b>88560</b></p> 	<p><b>HUB ADAPTER, THREADED OUTLET</b></p> <table border="1"> <thead> <tr> <th colspan="2">LIST PRICE</th> </tr> <tr> <th>PIPE SIZE</th> <th></th> </tr> </thead> <tbody> <tr> <td>2"</td> <td></td> </tr> <tr> <td>3"</td> <td></td> </tr> <tr> <td>4"</td> <td></td> </tr> <tr> <td>5"</td> <td></td> </tr> <tr> <td>6"</td> <td></td> </tr> <tr> <td>8"</td> <td></td> </tr> </tbody> </table> <p>ADD FOR OPTIONS: -40 (2" - 4") ..... -40 (5" - 8") .....</p>	LIST PRICE		PIPE SIZE		2"		3"		4"		5"		6"		8"		<p><b>88950</b></p> 	<p><b>FRESH AIR INLET</b></p> <table border="1"> <thead> <tr> <th colspan="2">LIST PRICE</th> </tr> <tr> <th>PIPE SIZE</th> <th></th> </tr> </thead> <tbody> <tr> <td>2", 3", 4"</td> <td></td> </tr> <tr> <td>5", 6"</td> <td></td> </tr> <tr> <td>8"</td> <td></td> </tr> </tbody> </table> <p>ADD FOR OPTIONS: -2 (2" - 4") ..... -2 (5", 6") ..... -2 (8") .....</p>	LIST PRICE		PIPE SIZE		2", 3", 4"		5", 6"		8"				
LIST PRICE																																
PIPE SIZE																																
2"																																
3"																																
4"																																
5"																																
6"																																
8"																																
LIST PRICE																																
PIPE SIZE																																
2", 3", 4"																																
5", 6"																																
8"																																
<p><b>88600</b></p> 	<p><b>REDUCING HUB ADAPTER</b></p> <table border="1"> <thead> <tr> <th colspan="3">LIST PRICE</th> </tr> <tr> <th>TYPE NO.</th> <th>PIPE SIZE</th> <th></th> </tr> </thead> <tbody> <tr> <td>88603-2</td> <td>2"</td> <td></td> </tr> <tr> <td>88604-2</td> <td>2"</td> <td></td> </tr> <tr> <td>88604-2-1/2</td> <td>2-1/2"</td> <td></td> </tr> <tr> <td>88604-3</td> <td>3"</td> <td></td> </tr> <tr> <td>88606-4</td> <td>4"</td> <td></td> </tr> </tbody> </table> <p>ADD FOR OPTIONS: -40 .....</p>	LIST PRICE			TYPE NO.	PIPE SIZE		88603-2	2"		88604-2	2"		88604-2-1/2	2-1/2"		88604-3	3"		88606-4	4"		<p><b>88970</b></p> 	<p><b>FRESH AIR INLET</b></p> <table border="1"> <thead> <tr> <th colspan="2">LIST PRICE</th> </tr> <tr> <th>PIPE SIZE</th> <th></th> </tr> </thead> <tbody> <tr> <td>4"</td> <td></td> </tr> <tr> <td>5"</td> <td></td> </tr> </tbody> </table> <p>ADD FOR OPTIONS: -8-2 ..... -VP .....</p>	LIST PRICE		PIPE SIZE		4"		5"	
LIST PRICE																																
TYPE NO.	PIPE SIZE																															
88603-2	2"																															
88604-2	2"																															
88604-2-1/2	2-1/2"																															
88604-3	3"																															
88606-4	4"																															
LIST PRICE																																
PIPE SIZE																																
4"																																
5"																																
<p><b>88900</b></p> 	<p><b>AIR GAP</b></p> <table border="1"> <thead> <tr> <th colspan="2">LIST PRICE</th> </tr> <tr> <th>TYPE NO.</th> <th></th> </tr> </thead> <tbody> <tr> <td>88900-1</td> <td></td> </tr> <tr> <td>88900-2</td> <td></td> </tr> <tr> <td>88900-3</td> <td></td> </tr> <tr> <td>88900-4</td> <td></td> </tr> <tr> <td>88900-5</td> <td></td> </tr> </tbody> </table> <p>ADD FOR OPTIONS: -40 .....</p>	LIST PRICE		TYPE NO.		88900-1		88900-2		88900-3		88900-4		88900-5		<p><b>Option Descriptions</b></p> <ul style="list-style-type: none"> <li>-ARE Acid-Resisting Epoxy</li> <li>-VP Secured Grate, Vandal-Proof Screws</li> <li>-2 Satin Finish Bronze Face</li> <li>-8 All Bronze</li> <li>-8-2 All Bronze with Satin Finish Face</li> <li>-10 Polished Chrome Plated</li> <li>-40 Galvanized Cast Iron Parts</li> <li>-49 3/4" Primer Tap</li> <li>-50 1/2" Primer Tap</li> <li>-51 Flushing Tap</li> <li>-60 Bronze Plug</li> <li>-72 Bronze Bucket</li> <li>-90 1/2" Female Copper Connection</li> <li>-91 1/2" Female Copper Union Connection</li> </ul>																
LIST PRICE																																
TYPE NO.																																
88900-1																																
88900-2																																
88900-3																																
88900-4																																
88900-5																																
<p><b>88910</b></p> 	<p><b>AIR GAP</b></p> <table border="1"> <thead> <tr> <th colspan="2">LIST PRICE</th> </tr> <tr> <th>PIPE SIZE</th> <th></th> </tr> </thead> <tbody> <tr> <td>88910-1</td> <td></td> </tr> <tr> <td>88910-2</td> <td></td> </tr> <tr> <td>88910-3</td> <td></td> </tr> <tr> <td>88910-4</td> <td></td> </tr> <tr> <td>88910-5</td> <td></td> </tr> </tbody> </table> <p>ADD FOR OPTIONS: -40 .....</p>	LIST PRICE		PIPE SIZE		88910-1		88910-2		88910-3		88910-4		88910-5																		
LIST PRICE																																
PIPE SIZE																																
88910-1																																
88910-2																																
88910-3																																
88910-4																																
88910-5																																

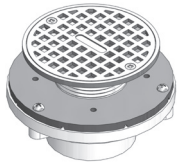
# LITE LINE FLOOR DRAINS

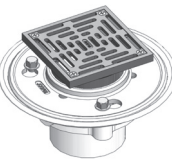

A WATTS Brand

 <p><b>FD-100-A</b></p>	<p>LEVELEZE® II C.I. BODY w/5" ROUND TOP w/TWO-STAGE HEIGHT ADJUSTMENT</p> <p><b>LIST PRICE</b></p> <table border="1"> <tr> <th>PIPE SIZE</th> <th>FD-100-A</th> </tr> <tr> <td>2"-5"*</td> <td></td> </tr> </table> <p>ADD FOR OPTIONS:</p> <p>-TSI† ..... -Y..... -VP ..... -YGTC (2"-4")..... -Z.....</p> <p>* 5" available in no-hub only    †Available up to 4" only</p>	PIPE SIZE	FD-100-A	2"-5"*		 <p><b>FD-210-4CP-SQ</b></p>	<p>PVC BODY w/SOLVENT WELD OUTLET AND 4" ADJUSTABLE SQUARE CHROME PLATED BRASS STRAINER</p> <p><b>LIST PRICE</b></p> <table border="1"> <tr> <th>PIPE SIZE</th> <th>FD-210-4CP-SQ</th> </tr> <tr> <td>2", 3", 4"</td> <td></td> </tr> </table> <p>ADD FOR OPTIONS:</p> <p>-TSI .....</p>	PIPE SIZE	FD-210-4CP-SQ	2", 3", 4"											
PIPE SIZE	FD-100-A																				
2"-5"*																					
PIPE SIZE	FD-210-4CP-SQ																				
2", 3", 4"																					
 <p><b>FD-100-S</b></p>	<p>LEVELEZE® II C.I. BODY w/5" SQUARE TOP w/TWO-STAGE HEIGHT ADJUSTMENT</p> <p><b>LIST PRICE</b></p> <table border="1"> <tr> <th>PIPE SIZE</th> <th>FD-100-S</th> </tr> <tr> <td>2"-5"*</td> <td></td> </tr> </table> <p>ADD FOR OPTIONS:</p> <p>-TSI† ..... -Y..... -VP ..... -YGTC (2"-4")..... -Z.....</p> <p>* 5" available in no-hub only    †Available up to 4" only</p>	PIPE SIZE	FD-100-S	2"-5"*		 <p><b>4CP &amp; 4CP-SQ</b></p>	<p>REPLACEMENT CHROME PLATED STRAINERS FOR FD-200 &amp; FD-210 SE- RIES</p> <p><b>LIST PRICE</b></p> <table border="1"> <tr> <th>4CP 4CP-SQ</th> <th></th> </tr> </table> <p>ADD FOR OPTIONS:</p> <p>-TSI .....</p>	4CP 4CP-SQ													
PIPE SIZE	FD-100-S																				
2"-5"*																					
4CP 4CP-SQ																					
 <p><b>FD-200-4CP</b></p>	<p>CAST IRON BODY w/4" ADJUSTABLE ROUND CHROME PLATED BRASS STRAINER</p> <p><b>LIST PRICE</b></p> <table border="1"> <tr> <th>PIPE SIZE</th> <th>FD-200-4CP</th> </tr> <tr> <td>2"</td> <td></td> </tr> </table> <p>ADD FOR OPTIONS:</p> <p>-ST..... -TSI..... -T..... -Z.....</p>	PIPE SIZE	FD-200-4CP	2"		 <p><b>FD-220</b></p>	<p>CAST IRON BODY w/6" SLOTTED CAST IRON, MEDIUM-DUTY GRATE</p> <p><b>LIST PRICE</b></p> <table border="1"> <tr> <th>PIPE SIZE</th> <th>FD-220</th> </tr> <tr> <td>2" Push-On (-Y) 3" No-Hub</td> <td></td> </tr> </table> <p>ADD FOR OPTIONS:</p> <p>-TSI .....</p>	PIPE SIZE	FD-220	2" Push-On (-Y) 3" No-Hub											
PIPE SIZE	FD-200-4CP																				
2"																					
PIPE SIZE	FD-220																				
2" Push-On (-Y) 3" No-Hub																					
 <p><b>FD-200-4CP-SQ</b></p>	<p>CAST IRON BODY w/4" ADJUSTABLE SQUARE CHROME PLATED BRASS STRAINER</p> <p><b>LIST PRICE</b></p> <table border="1"> <tr> <th>PIPE SIZE</th> <th>FD-200-4CP-SQ</th> </tr> <tr> <td>2"</td> <td></td> </tr> </table> <p>ADD FOR OPTIONS:</p> <p>-ST..... -TSI..... -T..... -Z.....</p>	PIPE SIZE	FD-200-4CP-SQ	2"		 <p><b>FD-250J-A</b></p>	<p>CAST IRON BODY w/ADJUSTABLE ROUND NIKALOY STRAINER AND NO-HUB BOTTOM OUTLET</p> <p><b>LIST PRICE</b></p> <table border="1"> <tr> <th rowspan="2">PIPE SIZE</th> <th colspan="4">WITH STRAINER</th> </tr> <tr> <th>5A</th> <th>6A</th> <th>7A</th> <th>8A</th> </tr> <tr> <td>4"</td> <td></td> <td></td> <td></td> <td></td> </tr> </table> <p>ADD FOR OPTIONS:</p> <p>-2..... -CP (6A)..... -80..... -J..... -92..... -SS..... -ARE..... -TSI..... -CP (5A)..... -VP.....</p>	PIPE SIZE	WITH STRAINER				5A	6A	7A	8A	4"				
PIPE SIZE	FD-200-4CP-SQ																				
2"																					
PIPE SIZE	WITH STRAINER																				
	5A	6A	7A	8A																	
4"																					
 <p><b>FD-210-4CP</b></p>	<p>PVC BODY w/SOLVENT WELD OUTLET AND 4" ADJUSTABLE ROUND CHROME PLATED BRASS STRAINER</p> <p><b>LIST PRICE</b></p> <table border="1"> <tr> <th>PIPE SIZE</th> <th>FD-210-4CP</th> </tr> <tr> <td>2", 3", 4"</td> <td></td> </tr> </table> <p>ADD FOR OPTIONS:</p> <p>-TSI.....</p>	PIPE SIZE	FD-210-4CP	2", 3", 4"		 <p><b>FD-250J-S</b></p>	<p>CAST IRON BODY w/ADJUSTABLE SQUARE NIKALOY STRAINER AND NO-HUB BOTTOM OUTLET</p> <p><b>LIST PRICE</b></p> <table border="1"> <tr> <th rowspan="2">PIPE SIZE</th> <th colspan="3">WITH STRAINER</th> </tr> <tr> <th>5S</th> <th>6S</th> <th>8S</th> </tr> <tr> <td>4"</td> <td></td> <td></td> <td></td> </tr> </table> <p>ADD FOR OPTIONS:</p> <p>-2..... -CP (6S)..... -80..... -J..... -92..... -SS..... -ARE..... -TSI..... -CP (5S)..... -VP.....</p>	PIPE SIZE	WITH STRAINER			5S	6S	8S	4"						
PIPE SIZE	FD-210-4CP																				
2", 3", 4"																					
PIPE SIZE	WITH STRAINER																				
	5S	6S	8S																		
4"																					

 <p><b>FD-300J-A</b></p>	<p>PVC 2-PIECE FLOOR DRAIN w/1/2" PRIMER TAP w/PLUG, SOLVENT WELD BOTTOM OUTLET FOR SCH 40 PVC PIPE AND ADJUSTABLE ROUND NIKALOY STRAINER</p> <table border="1"> <thead> <tr> <th colspan="5">LIST PRICE</th> </tr> <tr> <th>PIPE SIZE</th> <th colspan="4">WITH STRAINER</th> </tr> </thead> <tbody> <tr> <td>2", 3", 4"</td> <td>5A</td> <td>6A</td> <td>7A</td> <td>8A</td> </tr> </tbody> </table> <p>ADD FOR OPTIONS:</p> <p>-2..... -TSI.....          -49..... -VP.....          -CP.....</p>	LIST PRICE					PIPE SIZE	WITH STRAINER				2", 3", 4"	5A	6A	7A	8A	 <p><b>FD-370</b></p>	<p>PVC FLOOR DRAIN w/FLANGE, 9" PVC GRATE AND SOLVENT WELD BOTTOM OUTLET FOR SCH 40 PVC PIPE</p> <table border="1"> <thead> <tr> <th colspan="2">LIST PRICE</th> </tr> <tr> <th>PIPE SIZE</th> <th>FD-370</th> </tr> </thead> <tbody> <tr> <td>2", 3", 4"</td> <td></td> </tr> </tbody> </table> <p>ADD FOR OPTIONS:</p> <p>-49..... -TSI.....          -50.....          -B.....          -HG.....</p>	LIST PRICE		PIPE SIZE	FD-370	2", 3", 4"		
LIST PRICE																									
PIPE SIZE	WITH STRAINER																								
2", 3", 4"	5A	6A	7A	8A																					
LIST PRICE																									
PIPE SIZE	FD-370																								
2", 3", 4"																									
 <p><b>FD-300J-S</b></p>	<p>PVC 2-PIECE FLOOR DRAIN w/ 1/2" PRIMER TAP w/PLUG, SOLVENT WELD BOTTOM OUTLET FOR SCH 40 PVC PIPE AND ADJUSTABLE SQUARE NIKALOY STRAINER</p> <table border="1"> <thead> <tr> <th colspan="4">LIST PRICE</th> </tr> <tr> <th>PIPE SIZE</th> <th colspan="3">WITH STRAINER</th> </tr> </thead> <tbody> <tr> <td>2", 3", 4"</td> <td>5S</td> <td>6S</td> <td>8S</td> </tr> </tbody> </table> <p>ADD FOR OPTIONS:</p> <p>-2.....          -49.....          -CP.....          -TSI.....          -VP.....</p>	LIST PRICE				PIPE SIZE	WITH STRAINER			2", 3", 4"	5S	6S	8S	 <p><b>FD-400</b></p>	<p>PVC FLOOR DRAIN w/SOLVENT WELD BOTTOM OUTLET FOR SCH 40 PVC PIPE AND 5" ADJUSTABLE ROUND STRAINER</p> <table border="1"> <thead> <tr> <th colspan="2">LIST PRICE</th> </tr> <tr> <th>PIPE SIZE</th> <th>WITH STRAINER</th> </tr> </thead> <tbody> <tr> <td>3" x 4"</td> <td>-J5PVC</td> </tr> <tr> <td>3" x 4"</td> <td>-J5NB Nickel Bronze</td> </tr> <tr> <td>3" x 4"</td> <td>-J5SC Scoriated Gasketed Solid Cover</td> </tr> </tbody> </table> <p>ADD FOR OPTIONS:</p> <p>-TSI..... -VP.....</p>	LIST PRICE		PIPE SIZE	WITH STRAINER	3" x 4"	-J5PVC	3" x 4"	-J5NB Nickel Bronze	3" x 4"	-J5SC Scoriated Gasketed Solid Cover
LIST PRICE																									
PIPE SIZE	WITH STRAINER																								
2", 3", 4"	5S	6S	8S																						
LIST PRICE																									
PIPE SIZE	WITH STRAINER																								
3" x 4"	-J5PVC																								
3" x 4"	-J5NB Nickel Bronze																								
3" x 4"	-J5SC Scoriated Gasketed Solid Cover																								
 <p><b>FD-310</b></p>	<p>CAST IRON 2-PIECE FLOOR DRAIN w/1/2" TRAP PRIMER w/PLUG AND 5" ADJUSTABLE ROUND NIKALOY STRAINER</p> <table border="1"> <thead> <tr> <th colspan="3">LIST PRICE</th> </tr> <tr> <th>TYPE NO.</th> <th>PIPE SIZE</th> <th></th> </tr> </thead> <tbody> <tr> <td>FD-312-Y</td> <td>2"</td> <td></td> </tr> <tr> <td>FD-312-Z</td> <td>2"</td> <td></td> </tr> <tr> <td>FD-313-Z</td> <td>3"</td> <td></td> </tr> <tr> <td>FD-313-Y</td> <td>3"</td> <td></td> </tr> <tr> <td>FD-314-Z</td> <td>4"</td> <td></td> </tr> </tbody> </table> <p>ADD FOR OPTIONS:</p> <p>-80..... -VP.....          -TSI..... -YGTC (2"-3").....</p>	LIST PRICE			TYPE NO.	PIPE SIZE		FD-312-Y	2"		FD-312-Z	2"		FD-313-Z	3"		FD-313-Y	3"		FD-314-Z	4"		<p><b>Lite Line Floor Drain Option Descriptions</b></p> <ul style="list-style-type: none"> <li>-ARE Acid-Resisting Epoxy</li> <li>-B Bucket, PVC</li> <li>-CP Chrome Plated</li> <li>-HG 1/2 Grate, PVC</li> <li>-J Backwater Valve</li> <li>-MD PVC Clamp Collar with 3" Socket Connection</li> <li>-SQ Square Rim</li> <li>-SS Stainless Steel</li> <li>-ST Shallow Trap</li> <li>-TSI Trap Seal Insert</li> <li>-VP Secured Grate, Vandal-Proof Screws</li> <li>-2 Satin Finish Bronze Top</li> <li>-49 3/4" Primer Tap</li> <li>-50 1/2" Primer Tap</li> <li>-80 Perforated Stainless Steel Basket</li> <li>-92 Galvanized Cast Iron Parts</li> </ul> <p>Outlet</p> <ul style="list-style-type: none"> <li>-T Threaded Outlet</li> <li>-Y Hub Outlet with Gasket</li> <li>-YGTC -Y Outlet Gasket with Test Cap</li> <li>-Z No-Hub Outlet</li> </ul>		
LIST PRICE																									
TYPE NO.	PIPE SIZE																								
FD-312-Y	2"																								
FD-312-Z	2"																								
FD-313-Z	3"																								
FD-313-Y	3"																								
FD-314-Z	4"																								

## LITE LINE FLOOR DRAINS (cont'd.)      LITE LINE ROOF DRAINS

**FD-450**



PVC FLOOR DRAIN w/SOLVENT WELD BOTTOM OUTLET FOR SCH 40 PVC PIPE AND 5" ADJUSTABLE ROUND STRAINER w/METAL RIM AND GRATE

LIST PRICE	
PIPE SIZE	WITH STRAINER
3" x 4"	-J5NBRG Nickel Bronze Rim and Grate
3" x 4"	-J5PBRG Polished Bronze Rim and Grate
3" x 4"	-J5SCRG Scoriated Gasketed Solid Cover

ADD FOR OPTIONS:  
 -SQ..... -VP.....  
 -TSI.....

**RD-300**



PVC BODY w/CAST IRON CLAMP RING, CAST IRON DOME AND SOLVENT WELD BOTTOM OUTLET

LIST PRICE	
PIPE SIZE	RD-300
2", 3", 4"	

ADD FOR OPTIONS:  
 -17..... -UC.....  
 -R..... -VP.....  
 -RC.....

**FD-450J-A**



PVC FLOOR DRAIN w/SOLVENT WELD BOTTOM OUTLET FOR SCH 40 PVC PIPE AND ADJUSTABLE ROUND NIKALOY STRAINER

LIST PRICE				
PIPE SIZE	WITH STRAINER			
	5A	6A	7A	8A
3" x 4"				

ADD FOR OPTIONS:  
 -2..... -VP.....  
 -TSI.....

**RD-700**



FITS ALL CLAMP RING AND HARDWARE FOR BOLT CENTERS 7-1/2" TO 11"

LIST PRICE	
RD-700	

**FD-450J-S**



PVC FLOOR DRAIN w/SOLVENT WELD BOTTOM OUTLET FOR SCH 40 PVC PIPE AND ADJUSTABLE SQUARE NIKALOY STRAINER

LIST PRICE			
PIPE SIZE	WITH STRAINER		
	5S	6S	8S
3" x 4"			

ADD FOR OPTIONS:  
 -2..... -VP.....  
 -TSI.....

**RD-700 TOP ASSY.**



FITS ALL TOP ASSEMBLY w/CAST IRON CLAMP RING, LARGE DOME AND HARDWARE

LIST PRICE		
700-AD	700-CD	700-PD
Aluminum Dome	Cast Iron Dome	Polypropylene Dome

ADD FOR OPTIONS:  
 -VP.....

**FD-500**



PVC FLOOR DRAIN w/SOLVENT WELD BOTTOM OUTLET FOR SCH 40 PVC PIPE AND 5" ADJUSTABLE ROUND STRAINER

LIST PRICE	
PIPE SIZE	WITH STRAINER
2", 3", 4"	-JJ5PVC
2", 3", 4"	-J5NB Nickel Bronze
2", 3", 4"	-J5SC Scoriated Gasketed Solid Cover









ADD FOR OPTIONS:  
 -TSI.....

**Lite Line Roof Drains Option Descriptions**

- R      Drain Receiver
- RC     Drain Receiver and Clips
- UC     Underdeck Clamp
- VP     Secured Dome, Vandal-Proof Screws
- 17     2" High Overflow Collar

**Lite Line Floor Drains Option Descriptions**

- SQ      Square Rim
- TSI     Trap Seal Insert
- VP     Secured Grate, Vandal-Proof Screws
- 2       Satin Finish Bronze Top

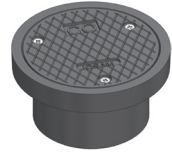
LITE LINE FLOOR SINKS		LITE LINE CLEANOUTS			
	12x12x6 PVC FLOOR SINK w/ MEDIUM-DUTY FULL PVC GRATE, ALUMINUM INTERNAL DOME STRAINER AND SOLVENT WELD OUTLET FOR SCH 40 PVC PIPE		LEVELEZE® II C.I. CLEANOUT w/5" ROUND TOP, INTERNAL PLUG AND TWO-STAGE HEIGHT ADJUSTMENT		
	LIST PRICE		LIST PRICE		
	PIPE SIZE		FS-940	PIPE SIZE	CO-100-A
	2", 3", 4"		2"-5"*		
	ADD FOR OPTIONS:		ADD FOR OPTIONS:		
-3Q.....	-NB.....	-VP.....	-YGTC (2"-4").....		
-HG.....	-TSI.....	-Y.....	-Z.....		
-LG.....		*5" available in no-hub only			
	8x8x6 ACID-RESISTING INTERIOR FLOOR SINK AND FULL GRATE w/ALUMINUM INTERNAL DOME STRAINER AND NO-HUB OUTLET		LEVELEZE® II C.I. CLEANOUT w/5" SQUARE TOP, INTERNAL PLUG AND TWO-STAGE HEIGHT ADJUSTMENT		
	LIST PRICE		LIST PRICE		
	PIPE SIZE		FS-100	PIPE SIZE	CO-100-S
	2", 3", 4"		2"-5"*		
	ADD FOR OPTIONS:		ADD FOR OPTIONS:		
-3.....	-33.....	-VP.....	-YGTC (2"-4").....		
-4.....	-LG.....	-Y.....	-Z.....		
-31.....	-TSI.....	*5" available in no-hub only			
	12x12x6 ACID-RESISTING INTERIOR FLOOR SINK AND FULL GRATE w/ALUMINUM INTERNAL DOME STRAINER AND NO-HUB OUTLET		CAST IRON CLEANOUT, ADJUSTABLE NIKALOY RIM AND COVER AND INTEGRAL GAS-TIGHT THREADED PLUG		
	LIST PRICE		LIST PRICE		
	PIPE SIZE		FS-120	TYPE NO.	PIPE SIZE
	2", 3", 4"		CO-312-Y	2"	
	ADD FOR OPTIONS:		CO-312-Z	2"	
-3.....	-33.....	CO-313-Z	3"		
-4.....	-LG.....	CO-313-Y	3"		
-31.....	-TSI.....	CO-314-Z	4"		
		ADD FOR OPTIONS:			
		-SQ Square Nickel Bronze Rim and Cover.....			
		-VP Secured Cover, Vandal-Proof Screws.....			
		-YGTC (2"-3").....			
	12x12x8 ACID-RESISTING INTERIOR FLOOR SINK AND FULL GRATE w/ALUMINUM INTERNAL DOME STRAINER AND NO-HUB OUTLET		PVC CLEANOUT w/ROUND (NIKALOY or CAST IRON) TOP w/BRONZE PLUG AND SOLVENT WELD BOTTOM OUTLET FOR FITTING OVER 3" AND INSIDE 4" SCH 40 DWV		
	LIST PRICE		LIST PRICE		
	PIPE SIZE		FS-140	PIPE SIZE	CO-430
	2", 3", 4"		3" x 4" - Nikaloy		
	ADD FOR OPTIONS:		3" x 4" - Cast Iron		
-3.....	-33.....	ADD FOR OPTIONS:			
-4.....	-LG.....	-2*.....	-VP.....		
-31.....	-TSI.....	-14.....			
		*For Nikaloy Top only			
	12x12x10 ACID-RESISTING INTERIOR FLOOR SINK AND FULL GRATE w/ALUMINUM INTERNAL DOME STRAINER AND NO-HUB OUTLET		CAST IRON CLEANOUT w/SECURED ROUND CAST IRON RIM AND COVER w/INTEGRAL BRASS PLUG AND 4" NO-HUB OUTLET		
	LIST PRICE		LIST PRICE		
	PIPE SIZE		FS-160	PIPE SIZE	WITH STRAINER
	2", 3", 4"		4"	-CI Rim and Cover (Std)	
	ADD FOR OPTIONS:		4"	-NB Nikaloy Rim and Cover	
-3.....	-33.....	4"	-NB-SQ Square Nikaloy Rim and Cover		
-4.....	-LG.....				
-31.....	-TSI.....				
<h3>Lite Line Floor Sink Option Descriptions</h3> <ul style="list-style-type: none"> <li>-HG 1/2 Grate (PVC)</li> <li>-3Q 3/4 Grate (PVC)</li> <li>-LG Less Grate</li> <li>-NB Nickel Bronze</li> <li>-TSI Trap Seal Insert</li> <li>-3 1/2 Grate (Acid-Resisting)</li> <li>-4 3/4 Grate (Acid-Resisting)</li> <li>-31 Aluminum Sediment Bucket</li> <li>-33 Acid-Resisting Finish Sediment Bucket</li> </ul>					
<h3>Lite Line Cleanout Option Descriptions</h3> <ul style="list-style-type: none"> <li>-2 Satin Finish Bronze Top</li> <li>-14 Carpet Cleanout Marker</li> <li>-SQ Square Nickel Bronze Rim &amp; Cover</li> <li>-VP Secured Cover, Vandal-Proof Screws</li> <li>Outlets</li> <li>-Y Hub Outlet w/Gasket 2"-4"</li> <li>-YGTC -Y Outlet Gasket w/Test Cap</li> <li>-Z No-Hub Outlet</li> </ul>					

## LITE LINE GREASE INTERCEPTORS

JG-0100S



### MANUAL CLEANING ON-FLOOR TYPE

TYPE NO.	PIPE SIZE	FLOW RATE GPM	GREASE CAPACITY LBS.	LIST PRICE	FOR OPTION, ADD TO LIST PRICE
					-EXT 6"
JG-0102S	2	7	14		
JG-0103S	2	10	20		
JG-0104S	2	15	30		
JG-0105S	3	20	40		
JG-0106S	3	25	50		
JG-0107S	3	35	70		
JG-0108S	3	50	100		
JG-0109S	3	75	150		
JG-0110S	4	100	200		

ADD FOR OPTIONS:

-EXT .....ABOVE

## LITE LINE SHOCK ABSORBERS

SA

### COPPER SHELL SHOCK ABSORBERS



SIZE	PIPE CONNECTION	LIST PRICE
SA-A	1/2	
SA-B	3/4	
SA-C	1	
SA-D	1	
SA-E	1	
SA-F	1	

## LITE LINE SHALLOW TRENCH DRAIN PRODUCTS

Part Number	Channel Size	Grate	Grate Size	Load Class	ADA/HP	List Price Per Foot*
TD-130-ABS	39.4"	ABS Perforated	19.7"	A	ADA/HP	
TD-130-GALV	39.4"	Galvanized Steel Slotted	39.4"	A	ADA	
TD-130-SS	39.4"	Stainless Steel Slotted	39.4"	A	ADA	
TD-130-CI	39.4"	Cast Iron Diagonal Slotted	19.7"	C	ADA	

Above pricing includes Neutral HDPE Channel, Grate, and Lock Bar. \*Pricing is estimated per foot price. Final orders are to be rounded to nearest 39.4".

ADD FOR OPTIONS:

-ECS      -110GSKT      -SSE      -GSE      -GABS      -GGALV      -GSS      -GCI      -LBK\*\*

\*This pricing is estimated per foot price. Final orders are to be rounded to nearest 39.4". \*\*Required every 19.7" when ordering replacement grates.

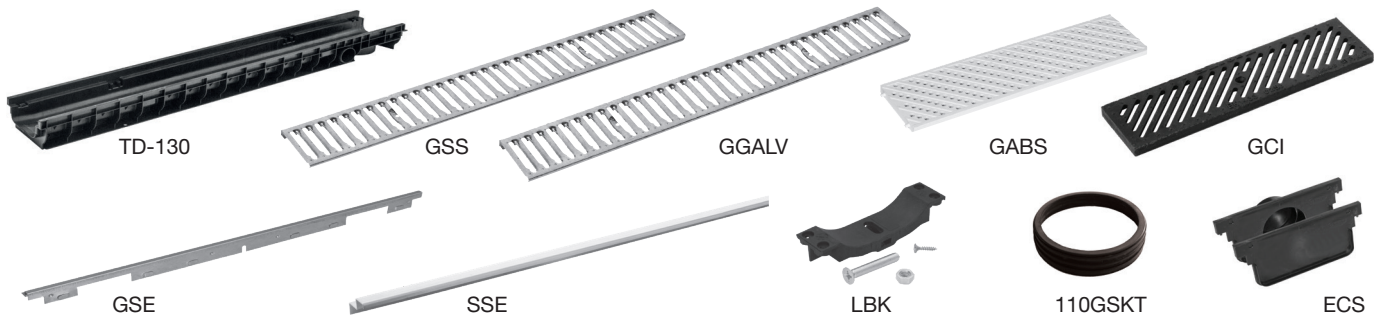

### Lite Line Trench Drain Option Descriptions

- |         |                                  |          |                       |
|---------|----------------------------------|----------|-----------------------|
| -TD-130 | Channel                          | -ECS     | End Cap Set           |
| -GABS   | ABS Perforated Grate             | -LBK     | Lock Bar Kit          |
| -GCI    | Cast Iron Diagonal Slotted Grate | -110GSKT | Gasket                |
| -GGALV  | Galvanized Steel Slotted Grate   | -SSE     | Stainless Steel Edge  |
| -GSS    | Stainless Steel Slotted Grate    | -GSE     | Galvanized Steel Edge |



## Superior Packaging, Labeling and Shipping

Josam ships its products pre-packaged, labeled with part numbers, and partially assembled at no extra charge!



Each item is individually wrapped and upon request tagged with specific product designations for easy on-site identification and transportation

Shrink wrapping protects product from harsh weather conditions and reduces lost parts

All Josam shrink wrap material is environmentally friendly and biodegradable



A **WATTS** Brand

T: (800) 365-6726 • [Josam.com](http://Josam.com)