

Josam Specification Drainage Products

2026 List Price Guide

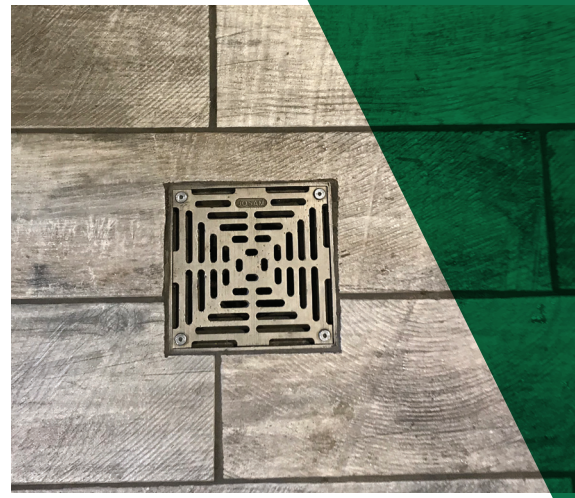
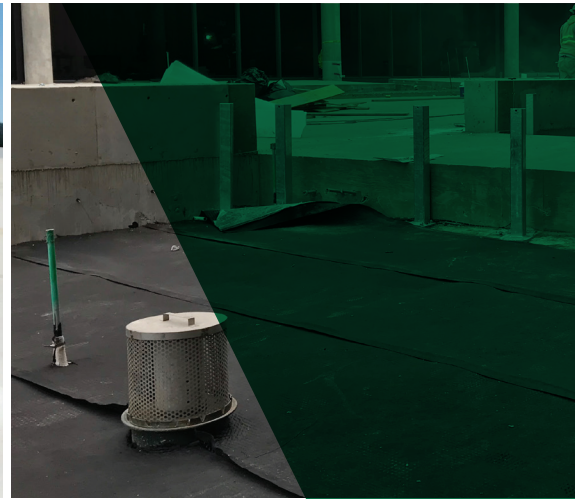

Effective: January 19, 2026

Josam also offers Stainless Steel Push-Fit Pipe & Fittings, a complete line of Stainless Steel Drains, and the PRO-PLUS® Trench Drain System.

Stainless Steel Push-Fit Drainage System



- Made of austenitic grade 316L Stainless Steel
- Gasketed "Push-Fit" design for cost effective installations
- 1 1/2" through 8" pipe size
- Specific gasket materials for different product applications
- Pressure ratings at least four times higher than previous generation systems
- Capable of being used in vacuum systems
- Corrosion, Fire, Heat, Impact, & Thermal Stress Resistance
- Strong and Lightweight

Stainless Steel Drainage Products



- 8", 10", and 12" adjustable and non-adjustable round top floor drains
- 6", 8", 10", 12", and 16" adjustable and non-adjustable square top floor drains
- 2" through 8" no-hub outlets for easy connection to existing piping
- 6", 8", 12", and 16" wide trench drains
- Grates for the lightest to heaviest of loads
- 5/16", 3/4", and 3" slot and mini channels
- Ability to customize products to meet project installation requirements

PRO-PLUS® Trench Drain System

- SMC/GRP Construction
- 1.5 times stronger than polymer concrete
- 70% Lighter than polymer concrete
- Shatterproof
- Available with and without slope
- 4" and 8" nominal interior widths
- Load Class A-F



For more information on these quality engineered drainage products, please visit www.josam.com or contact your local Josam representative.

TABLE OF CONTENTS

Specification Products

Closet Carriers	3-4
Fixture Carriers.....	5-6
Roof Drains	6-10
Floor Drains.....	11-19
Sanitary Floor Sinks.....	19-21
Stainless Steel Retrofit Liners for Sanitary Floor Sinks.....	22
Cleanouts.....	23-25
Interceptors.....	26-30
Backwater Valves	31
Hydrants	32
Shock Absorbers	33
Trench Drains	33-34
Miscellaneous Products	34
Traps & Accessories.....	35-36

Lite Line Products

Floor Drains.....	37-39
Roof Drains	39
Floor Sinks.....	40
Cleanouts.....	40
Interceptors.....	41
Shock Absorbers	41
Shallow Trench Drain Products.....	41

HOW TO USE THIS PRICE GUIDE

Every product in this guide is provided with list prices for the product and its options in a concise table. The description of each option is shown in the lower right corner of each page spread. A thumbnail photo is included for quick identification. All drawings and dimensions are available at www.Josam.com.

All prices are list prices. Please consult your local Josam representative for your current multiplier.



*Partial or Full Domestic Content
on Specification Product Line
available upon request.*

Effective: January 19, 2026

List Price Guide – 2026

Supersedes all previously published terms and conditions. Subject to change without notice.

Applicable to all sales of, and contracts to sell products of Josam Company
CONTACT YOUR JOSAM REPRESENTATIVE FOR DETAILS ON DISCOUNT

PAYMENT TERMS:

For accounts with established credit, payment terms are 2% cash discount, payable 30 days from date of invoice, net 31 days. Invoices still unpaid after 31 days from date of invoice will be subject to interest charges of 1-1/2% per month. Minimum invoice: \$25.00 net. Confirmed irrevocable letter of credit or cash in advance of shipment is required for accounts without an established line of credit. Any terms and conditions appearing on your orders which are inconsistent with the terms of our quotation and conditions of sale shall be of no effect.

FREIGHT ALLOWANCE:

Specification Products (Pages 3-35)

All shipments will be F.O.B. Michigan City, Indiana or Service Center. A freight allowance will be made on all shipments of \$5,000.00 net amount or more within the continental USA except for Alaska, Hawaii and Puerto Rico.

Lite Line Products (Pages 36-40)

All shipments will be F.O.B. Michigan City, Indiana or Service Center. A freight allowance will be made on all shipments of \$1,000.00 net amount or more within the continental USA except for Alaska, Hawaii and Puerto Rico.

Specification Product Line products and Lite Line products may not be combined to obtain minimum freight requirements for full freight allowance.

Full freight allowance is limited to normal ground services and does not include charges for specially expedited or guaranteed deliveries requiring air shipment or guaranteed motor freight contracts.

RETURN POLICY:

Standard catalog material may be returned only upon written authorization of Seller. Requests to return material must be received by Josam Company within 60 days of date of original shipment made by Josam Company. Buyer must return material within 30 days from the date of Seller's written authorization. Credit will be issued to the Buyer's account toward purchase of additional material only. Obsolete, discontinued or specially produced items will not be accepted for return and credit.

Where return results from causes involving Buyer's responsibility, credit for saleable goods returned will be issued at invoice price less a 25% restocking charge for handling and inspection. Return of less than \$100.00 net price will not be allowed. For other than saleable goods returned, any necessary charges to render the returned material saleable will be added. Galvanized material will be credited at the same value as painted cast iron. Chrome plated material will be credited at the value of satin finish bronze. We will issue credit for returned parts only originally ordered as a part. On all returns, incoming and outgoing freight charges to and from Michigan City, Indiana, will be deducted from any credit allowed.

WARRANTY:

Our products are warranted to be free of defects in material and workmanship for a period of one year from date of shipment, but our liability shall be limited solely to those defects, which our inspection finds to be due to our fault. Notification of a claim for defective material or workmanship must be given in writing to Josam Company. WE SHALL NOT BE RESPONSIBLE FOR ANY LABOR CHARGES OR ANY LOSS, INJURY OR DAMAGES WHATSOEVER, INCLUDING INCIDENTAL OR CONSEQUENTIAL DAMAGES. The sole and exclusive remedy shall be limited to the replacement or repair of the defective goods at the Seller's discretion. Before installation and use, Buyer shall determine the suitability of the product for his intended use and the Buyer assumes all risk and liability whatever in connection therewith.

Notification of a claim for material shortage or incorrect material must be given in writing to Josam Company within 15 days of shipment.

QUOTATIONS:

Quotations are based on discount in effect at the time of quotation and will be protected on this basis for a period of 30 days from date of quotation.

EXPORT ORDERS:

Factors which govern export orders differ from domestic orders. Please contact Josam Customer Service.

ACCEPTANCE OF ORDERS:

All catalogs, price lists or other literature describing our products are not to be construed as offers to sell same. All orders are subject to acceptance by the general office of Seller in Michigan City, Indiana, either by shipment or by written acceptance. Your order, when shipped or accepted by us, shall constitute the complete contract between us, subject to and incorporating therein the terms and conditions herein contained, and any inconsistent provisions contained in your order shall not apply. Prices, discounts and special programs contained in any of our catalogs, price lists or other literature are subject to change without notice.

CANCELLATION:

Orders are not subject to cancellation without our written consent. If an order is cancelled, the Buyer shall pay all costs incurred in connection with filling the order. Any items not cataloged or items not normally stocked by us and made or purchased to fill the order become the Buyer's property and must be paid for by the Buyer.

ILLUSTRATIONS, DESCRIPTIONS AND DIMENSIONS:

All illustrations, descriptions, and detailed dimensions represent standard features and do not necessarily indicate all variations available. All weights stated in our catalogs, literature and drawings are approximate and are not guaranteed.

All designs, descriptions and dimensions are subject to change without notice, and unless Buyer specifically states otherwise on order, standard products in effect at time order is shipped will be supplied.

RISKS:







Our responsibility ceases after the product has been delivered to the carrier in good order. It is the responsibility of the consignee to inspect each shipment carefully and file a claim with the carrier for any damage or shortage. Content shortages must be reported within 15 days after receipt of material.



DELIVERY:

Shipping dates are estimates and time of delivery is not the essence of this sale or the contract therefor. We will ship as near schedule as possible. Under no circumstances will the Seller have any responsibility on account of any delays in manufacture, transportation, or otherwise. Material is subject to shipment in whole or in part, at our option, and each shipment is subject to immediate invoicing.

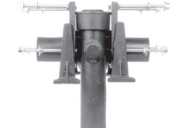
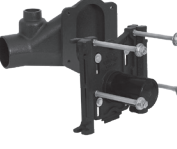
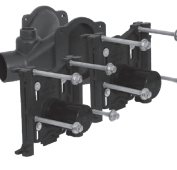

TAXES:

Any sales, or manufacturers' tax imposed under existing or future statutes shall be added to the price herewith effective and shall be paid by the Buyer unless proper exemption certificates are filed with Josam Company.

<p>11001 11007</p> 	<p align="center">CLOSET CARRIERS</p> <p align="center">LIST PRICE</p> <table border="1"> <tr> <th colspan="2">SERIES NO.</th> </tr> <tr> <td>11001 w/ 4" Pipe Grip Adapter</td> <td>\$1,251.00</td> </tr> <tr> <td>11007 w/ 3" Copper Ftg. Adapter</td> <td>1,327.00</td> </tr> </table> <p>ADD FOR OPTIONS:</p> <p>-35* \$916.00</p> <p>*Not Available on 11007.</p>	SERIES NO.		11001 w/ 4" Pipe Grip Adapter	\$1,251.00	11007 w/ 3" Copper Ftg. Adapter	1,327.00	<p>12724</p> 	<p align="center">VERTICAL ADJUSTABLE BACK-TO-BACK, NO-HUB, ON STACK</p> <p align="center">LIST PRICE</p> <table border="1"> <tr> <th>SERIES NO.</th> <th>No-Hub</th> <th>-HS</th> </tr> <tr> <td>12724 Back-to-Back 2" Vent</td> <td>\$5,263.00</td> <td>\$5,391.00</td> </tr> </table> <p>ADD FOR OPTIONS:</p> <table border="0"> <tr> <td>-1 \$264.00</td> <td>-HS \$129.00</td> </tr> <tr> <td>-6 284.00</td> <td>-HD4 1,016.00</td> </tr> <tr> <td>-6CU 284.00</td> <td>-HVS4 508.00</td> </tr> <tr> <td>-10 0.00</td> <td>-OR 0.00</td> </tr> <tr> <td>-24 Deduct 516.00</td> <td>-OS4 508.00</td> </tr> <tr> <td>-30 0.00</td> <td>-PAC 0.00</td> </tr> <tr> <td>-30-2 0.00</td> <td>-PAF 0.00</td> </tr> <tr> <td>-32 1,595.00</td> <td>-PF 0.00</td> </tr> <tr> <td>-35 0.00</td> <td>-PFG 0.00</td> </tr> <tr> <td>-49 605.00</td> <td>-PS 0.00</td> </tr> <tr> <td>-50 605.00</td> <td>-SDH (750 LB.) 1,765.00</td> </tr> <tr> <td>-53 605.00</td> <td>-TB 639.00</td> </tr> <tr> <td>-54 605.00</td> <td>-VP 436.00</td> </tr> <tr> <td>-58 919.00</td> <td>-VS4 508.00</td> </tr> <tr> <td>-CR 0.00</td> <td>-XSD (1000 lb.) 2,410.00</td> </tr> <tr> <td>-D4 1,016.00</td> <td></td> </tr> </table>	SERIES NO.	No-Hub	-HS	12724 Back-to-Back 2" Vent	\$5,263.00	\$5,391.00	-1 \$264.00	-HS \$129.00	-6 284.00	-HD4 1,016.00	-6CU 284.00	-HVS4 508.00	-10 0.00	-OR 0.00	-24 Deduct 516.00	-OS4 508.00	-30 0.00	-PAC 0.00	-30-2 0.00	-PAF 0.00	-32 1,595.00	-PF 0.00	-35 0.00	-PFG 0.00	-49 605.00	-PS 0.00	-50 605.00	-SDH (750 LB.) 1,765.00	-53 605.00	-TB 639.00	-54 605.00	-VP 436.00	-58 919.00	-VS4 508.00	-CR 0.00	-XSD (1000 lb.) 2,410.00	-D4 1,016.00																																																																									
SERIES NO.																																																																																																																							
11001 w/ 4" Pipe Grip Adapter	\$1,251.00																																																																																																																						
11007 w/ 3" Copper Ftg. Adapter	1,327.00																																																																																																																						
SERIES NO.	No-Hub	-HS																																																																																																																					
12724 Back-to-Back 2" Vent	\$5,263.00	\$5,391.00																																																																																																																					
-1 \$264.00	-HS \$129.00																																																																																																																						
-6 284.00	-HD4 1,016.00																																																																																																																						
-6CU 284.00	-HVS4 508.00																																																																																																																						
-10 0.00	-OR 0.00																																																																																																																						
-24 Deduct 516.00	-OS4 508.00																																																																																																																						
-30 0.00	-PAC 0.00																																																																																																																						
-30-2 0.00	-PAF 0.00																																																																																																																						
-32 1,595.00	-PF 0.00																																																																																																																						
-35 0.00	-PFG 0.00																																																																																																																						
-49 605.00	-PS 0.00																																																																																																																						
-50 605.00	-SDH (750 LB.) 1,765.00																																																																																																																						
-53 605.00	-TB 639.00																																																																																																																						
-54 605.00	-VP 436.00																																																																																																																						
-58 919.00	-VS4 508.00																																																																																																																						
-CR 0.00	-XSD (1000 lb.) 2,410.00																																																																																																																						
-D4 1,016.00																																																																																																																							
<p>12673 12674</p> 	<p align="center">3" HORIZONTAL NO-HUB ADJUSTABLE</p> <p align="center">LIST PRICE</p> <p align="center">3" Pipe Connections</p> <table border="1"> <tr> <th>SERIES NO.</th> <th>12673 Single L.H.</th> <th>12683 Single R.H.</th> <th>12693 Back-to-Back</th> </tr> <tr> <td>No-Hub</td> <td>\$2,369.00</td> <td>\$2,369.00</td> <td>\$4,393.00</td> </tr> </table> <p align="center">4" HORIZONTAL NO-HUB ADJUSTABLE</p> <p align="center">LIST PRICE</p> <p align="center">4" Pipe Connections</p> <table border="1"> <tr> <th>SERIES NO.</th> <th>12674 Single L.H.</th> <th>12684 Single R.H.</th> <th>12694 Back-to-Back</th> </tr> <tr> <td>No-Hub</td> <td>\$2,629.00</td> <td>\$2,629.00</td> <td>\$4,909.00</td> </tr> <tr> <td>-HS</td> <td>2,629.00</td> <td>2,629.00</td> <td>4,909.00</td> </tr> <tr> <td>-58</td> <td>3,547.00</td> <td>3,547.00</td> <td>5,828.00</td> </tr> <tr> <td>-HS-58</td> <td>3,547.00</td> <td>3,547.00</td> <td>5,828.00</td> </tr> </table>	SERIES NO.	12673 Single L.H.	12683 Single R.H.	12693 Back-to-Back	No-Hub	\$2,369.00	\$2,369.00	\$4,393.00	SERIES NO.	12674 Single L.H.	12684 Single R.H.	12694 Back-to-Back	No-Hub	\$2,629.00	\$2,629.00	\$4,909.00	-HS	2,629.00	2,629.00	4,909.00	-58	3,547.00	3,547.00	5,828.00	-HS-58	3,547.00	3,547.00	5,828.00	<p>14004</p>  <p>14024 (R.H. Not Shown)</p> <p>14044</p> 	<p align="center">VERTICAL CLOSE HUB & SPIGOT, OFFSET</p> <p align="center">LIST PRICE</p> <table border="1"> <tr> <th>SERIES NO.</th> <th>Price</th> </tr> <tr> <td>14004 Sgl. L.H., L.H. 2" Vent</td> <td>\$2,360.00</td> </tr> <tr> <td>14024 Sgl. R.H., R.H. 2" Vent</td> <td>2,360.00</td> </tr> <tr> <td>14044 Back-to-Back, 2" Vent</td> <td>4,041.00</td> </tr> </table> <p>ADD FOR OPTIONS:</p> <table border="0"> <tr> <td>-1* \$134.00</td> <td>-54 \$605.00</td> </tr> <tr> <td>-6* 141.00</td> <td>-VP* 217.00</td> </tr> <tr> <td>-6CU* 141.00</td> <td>-XSD (1000 lb.)* 1,205.00</td> </tr> <tr> <td>-10 0.00</td> <td>-21* 542.00</td> </tr> </table> <p>* Pricing for options is per fixture. Add or subtract twice for Back-to-Back Carriers</p>	SERIES NO.	Price	14004 Sgl. L.H., L.H. 2" Vent	\$2,360.00	14024 Sgl. R.H., R.H. 2" Vent	2,360.00	14044 Back-to-Back, 2" Vent	4,041.00	-1* \$134.00	-54 \$605.00	-6* 141.00	-VP* 217.00	-6CU* 141.00	-XSD (1000 lb.)* 1,205.00	-10 0.00	-21* 542.00																																																																								
SERIES NO.	12673 Single L.H.	12683 Single R.H.	12693 Back-to-Back																																																																																																																				
No-Hub	\$2,369.00	\$2,369.00	\$4,393.00																																																																																																																				
SERIES NO.	12674 Single L.H.	12684 Single R.H.	12694 Back-to-Back																																																																																																																				
No-Hub	\$2,629.00	\$2,629.00	\$4,909.00																																																																																																																				
-HS	2,629.00	2,629.00	4,909.00																																																																																																																				
-58	3,547.00	3,547.00	5,828.00																																																																																																																				
-HS-58	3,547.00	3,547.00	5,828.00																																																																																																																				
SERIES NO.	Price																																																																																																																						
14004 Sgl. L.H., L.H. 2" Vent	\$2,360.00																																																																																																																						
14024 Sgl. R.H., R.H. 2" Vent	2,360.00																																																																																																																						
14044 Back-to-Back, 2" Vent	4,041.00																																																																																																																						
-1* \$134.00	-54 \$605.00																																																																																																																						
-6* 141.00	-VP* 217.00																																																																																																																						
-6CU* 141.00	-XSD (1000 lb.)* 1,205.00																																																																																																																						
-10 0.00	-21* 542.00																																																																																																																						
<p>12683 12684</p>  <p>12693 12694</p> 	<p>ADD FOR OPTIONS:</p> <table border="0"> <tr> <td>-1* \$134.00</td> <td>-HS† \$0.00</td> </tr> <tr> <td>-6* 141.00</td> <td>-OR 0.00</td> </tr> <tr> <td>-6CU* 141.00</td> <td>-PAC 0.00</td> </tr> <tr> <td>-10 0.00</td> <td>-PAF 0.00</td> </tr> <tr> <td>-24* Deduct 257.00</td> <td>-PF 0.00</td> </tr> <tr> <td>-30 0.00</td> <td>-PFG 0.00</td> </tr> <tr> <td>-30-2 0.00</td> <td>-PS 0.00</td> </tr> <tr> <td>-32* 796.00</td> <td>-SDH (750 LB.)* 882.00</td> </tr> <tr> <td>-35 0.00</td> <td>-TB* 320.00</td> </tr> <tr> <td>-58† 919.00</td> <td>-VP* 217.00</td> </tr> <tr> <td>-AUX** 605.00</td> <td>-XSD (1000 LB.)* 1,205.00</td> </tr> <tr> <td>-CR 0.00</td> <td></td> </tr> </table> <p>*Pricing for options is per fixture. Add or subtract twice for Back-to-Back Carriers</p> <p>** Not Available on 12694</p> <p>† Not Available on 12673, 12683, and 12693</p>	-1* \$134.00	-HS† \$0.00	-6* 141.00	-OR 0.00	-6CU* 141.00	-PAC 0.00	-10 0.00	-PAF 0.00	-24* Deduct 257.00	-PF 0.00	-30 0.00	-PFG 0.00	-30-2 0.00	-PS 0.00	-32* 796.00	-SDH (750 LB.)* 882.00	-35 0.00	-TB* 320.00	-58† 919.00	-VP* 217.00	-AUX** 605.00	-XSD (1000 LB.)* 1,205.00	-CR 0.00		<p align="center">Option Descriptions</p> <table border="0"> <tr> <td>-AUX</td> <td>Auxiliary Inlet, 2"</td> <td>-1</td> <td>Positioning Frame</td> </tr> <tr> <td>-CR</td> <td>Compression Ring Carrier</td> <td>-6</td> <td>Supply Pipe Support - Galvanized Pipe</td> </tr> <tr> <td>-D4</td> <td>Double 4" No-Hub Branches</td> <td>-6CU</td> <td>Supply Pipe Support - Copper Pipe</td> </tr> <tr> <td>-HD4</td> <td>Double 4" Hub Branches</td> <td>-10</td> <td>ABS Extension through 10-1/2" Wall</td> </tr> <tr> <td>-HLH4</td> <td>Left-Hand 4" Hub Branch</td> <td>-21</td> <td>Hanger Type Closet Adapter</td> </tr> <tr> <td>-HRH4</td> <td>Right-Hand 4" Hub Branch</td> <td>-24</td> <td>Carrier for Floor-Mounted, Back-Outlet China Bowls</td> </tr> <tr> <td>-HS</td> <td>Hub & Spigot</td> <td>-30</td> <td>Cast Iron Adjustable Extension with Connector and Test Cap</td> </tr> <tr> <td>-HVS4</td> <td>Vent Side 4" Hub Branch</td> <td>-32</td> <td>Carrier for Wide Chase Installations</td> </tr> <tr> <td>-6CU</td> <td>Supply Pipe Support - Copper</td> <td>-35</td> <td>Closet Carrier for Wheelchair High Rough</td> </tr> <tr> <td>-LH4</td> <td>Left-Hand 4" No-Hub Branch</td> <td>-49</td> <td>No-Hub High Auxiliary Inlet, Under Vent</td> </tr> <tr> <td>-OR</td> <td>O-Ring Carrier</td> <td>-50</td> <td>No-Hub High Auxiliary Inlet, Opposite Vent</td> </tr> <tr> <td>-OS4</td> <td>Opposite Vent 4" No-Hub Branch</td> <td>-53</td> <td>Threaded High Auxiliary Inlet, Under Vent</td> </tr> <tr> <td>-PAC</td> <td>Pre-Assembled Carrier</td> <td>-54</td> <td>Threaded High Auxiliary Inlet, Opposite Vent</td> </tr> <tr> <td>-PAF</td> <td>Prefab Adjustable Foot</td> <td>-58</td> <td>Horizontal No-Hub Cast Long Barrel</td> </tr> <tr> <td>-PF</td> <td>Pylon Foot, Standard</td> <td></td> <td></td> </tr> <tr> <td>-PFG</td> <td>Alternate Prefab Faceplate Gasket (Standard with PAF)</td> <td></td> <td></td> </tr> <tr> <td>-PS</td> <td>Foam Sleeve for Extension</td> <td></td> <td></td> </tr> <tr> <td>-RH4</td> <td>Right-Hand 4" No-Hub Branch</td> <td></td> <td></td> </tr> <tr> <td>-SDH</td> <td>Special-Duty 750 lb. Carrier</td> <td></td> <td></td> </tr> <tr> <td>-TB</td> <td>Test Bracket</td> <td></td> <td></td> </tr> <tr> <td>-VP</td> <td>Vandal-Proof Trim</td> <td></td> <td></td> </tr> <tr> <td>-VS4</td> <td>Vent Side 4" No-Hub Branch</td> <td></td> <td></td> </tr> <tr> <td>-XSD</td> <td>Extra Special-Duty 1,000 lb. Carrier</td> <td></td> <td></td> </tr> </table>		-AUX	Auxiliary Inlet, 2"	-1	Positioning Frame	-CR	Compression Ring Carrier	-6	Supply Pipe Support - Galvanized Pipe	-D4	Double 4" No-Hub Branches	-6CU	Supply Pipe Support - Copper Pipe	-HD4	Double 4" Hub Branches	-10	ABS Extension through 10-1/2" Wall	-HLH4	Left-Hand 4" Hub Branch	-21	Hanger Type Closet Adapter	-HRH4	Right-Hand 4" Hub Branch	-24	Carrier for Floor-Mounted, Back-Outlet China Bowls	-HS	Hub & Spigot	-30	Cast Iron Adjustable Extension with Connector and Test Cap	-HVS4	Vent Side 4" Hub Branch	-32	Carrier for Wide Chase Installations	-6CU	Supply Pipe Support - Copper	-35	Closet Carrier for Wheelchair High Rough	-LH4	Left-Hand 4" No-Hub Branch	-49	No-Hub High Auxiliary Inlet, Under Vent	-OR	O-Ring Carrier	-50	No-Hub High Auxiliary Inlet, Opposite Vent	-OS4	Opposite Vent 4" No-Hub Branch	-53	Threaded High Auxiliary Inlet, Under Vent	-PAC	Pre-Assembled Carrier	-54	Threaded High Auxiliary Inlet, Opposite Vent	-PAF	Prefab Adjustable Foot	-58	Horizontal No-Hub Cast Long Barrel	-PF	Pylon Foot, Standard			-PFG	Alternate Prefab Faceplate Gasket (Standard with PAF)			-PS	Foam Sleeve for Extension			-RH4	Right-Hand 4" No-Hub Branch			-SDH	Special-Duty 750 lb. Carrier			-TB	Test Bracket			-VP	Vandal-Proof Trim			-VS4	Vent Side 4" No-Hub Branch			-XSD	Extra Special-Duty 1,000 lb. Carrier		
-1* \$134.00	-HS† \$0.00																																																																																																																						
-6* 141.00	-OR 0.00																																																																																																																						
-6CU* 141.00	-PAC 0.00																																																																																																																						
-10 0.00	-PAF 0.00																																																																																																																						
-24* Deduct 257.00	-PF 0.00																																																																																																																						
-30 0.00	-PFG 0.00																																																																																																																						
-30-2 0.00	-PS 0.00																																																																																																																						
-32* 796.00	-SDH (750 LB.)* 882.00																																																																																																																						
-35 0.00	-TB* 320.00																																																																																																																						
-58† 919.00	-VP* 217.00																																																																																																																						
-AUX** 605.00	-XSD (1000 LB.)* 1,205.00																																																																																																																						
-CR 0.00																																																																																																																							
-AUX	Auxiliary Inlet, 2"	-1	Positioning Frame																																																																																																																				
-CR	Compression Ring Carrier	-6	Supply Pipe Support - Galvanized Pipe																																																																																																																				
-D4	Double 4" No-Hub Branches	-6CU	Supply Pipe Support - Copper Pipe																																																																																																																				
-HD4	Double 4" Hub Branches	-10	ABS Extension through 10-1/2" Wall																																																																																																																				
-HLH4	Left-Hand 4" Hub Branch	-21	Hanger Type Closet Adapter																																																																																																																				
-HRH4	Right-Hand 4" Hub Branch	-24	Carrier for Floor-Mounted, Back-Outlet China Bowls																																																																																																																				
-HS	Hub & Spigot	-30	Cast Iron Adjustable Extension with Connector and Test Cap																																																																																																																				
-HVS4	Vent Side 4" Hub Branch	-32	Carrier for Wide Chase Installations																																																																																																																				
-6CU	Supply Pipe Support - Copper	-35	Closet Carrier for Wheelchair High Rough																																																																																																																				
-LH4	Left-Hand 4" No-Hub Branch	-49	No-Hub High Auxiliary Inlet, Under Vent																																																																																																																				
-OR	O-Ring Carrier	-50	No-Hub High Auxiliary Inlet, Opposite Vent																																																																																																																				
-OS4	Opposite Vent 4" No-Hub Branch	-53	Threaded High Auxiliary Inlet, Under Vent																																																																																																																				
-PAC	Pre-Assembled Carrier	-54	Threaded High Auxiliary Inlet, Opposite Vent																																																																																																																				
-PAF	Prefab Adjustable Foot	-58	Horizontal No-Hub Cast Long Barrel																																																																																																																				
-PF	Pylon Foot, Standard																																																																																																																						
-PFG	Alternate Prefab Faceplate Gasket (Standard with PAF)																																																																																																																						
-PS	Foam Sleeve for Extension																																																																																																																						
-RH4	Right-Hand 4" No-Hub Branch																																																																																																																						
-SDH	Special-Duty 750 lb. Carrier																																																																																																																						
-TB	Test Bracket																																																																																																																						
-VP	Vandal-Proof Trim																																																																																																																						
-VS4	Vent Side 4" No-Hub Branch																																																																																																																						
-XSD	Extra Special-Duty 1,000 lb. Carrier																																																																																																																						
<p>12704</p>  <p>12714</p> 	<p align="center">VERTICAL ADJUSTABLE SINGLE, NO-HUB, ON STACK</p> <p align="center">LIST PRICE</p> <table border="1"> <tr> <th>SERIES NO.</th> <th>No-Hub</th> <th>-HS</th> </tr> <tr> <td>12704 L.Hand 2" Vent</td> <td>\$2,978.00</td> <td>\$3,107.00</td> </tr> <tr> <td>12714 R.Hand 2" Vent</td> <td>2,978.00</td> <td>3,107.00</td> </tr> </table> <p>ADD FOR OPTIONS:</p> <table border="0"> <tr> <td>-1 \$134.00</td> <td>-HD4 \$1,016.00</td> </tr> <tr> <td>-6 141.00</td> <td>-HLH4 508.00</td> </tr> <tr> <td>-6CU 141.00</td> <td>-HRH4 508.00</td> </tr> <tr> <td>-10 0.00</td> <td>-HS 129.00</td> </tr> <tr> <td>-24 Deduct 260.00</td> <td>-LH4 508.00</td> </tr> <tr> <td>-30 0.00</td> <td>-OR 0.00</td> </tr> <tr> <td>-30-2 0.00</td> <td>-PAC 0.00</td> </tr> <tr> <td>-32 796.00</td> <td>-PAF 0.00</td> </tr> <tr> <td>-35 0.00</td> <td>-PF 0.00</td> </tr> <tr> <td>-49 605.00</td> <td>-PFG 0.00</td> </tr> <tr> <td>-50 605.00</td> <td>-PS 0.00</td> </tr> <tr> <td>-53 605.00</td> <td>-RH4 508.00</td> </tr> <tr> <td>-54 605.00</td> <td>-SDH (750 lb.) 882.00</td> </tr> <tr> <td>-58 919.00</td> <td>-TB 320.00</td> </tr> <tr> <td>-CR 0.00</td> <td>-VP 217.00</td> </tr> <tr> <td>-D4 1,016.00</td> <td>-XSD (1000 lb.) 1,205.00</td> </tr> </table>	SERIES NO.	No-Hub	-HS	12704 L.Hand 2" Vent	\$2,978.00	\$3,107.00	12714 R.Hand 2" Vent	2,978.00	3,107.00	-1 \$134.00	-HD4 \$1,016.00	-6 141.00	-HLH4 508.00	-6CU 141.00	-HRH4 508.00	-10 0.00	-HS 129.00	-24 Deduct 260.00	-LH4 508.00	-30 0.00	-OR 0.00	-30-2 0.00	-PAC 0.00	-32 796.00	-PAF 0.00	-35 0.00	-PF 0.00	-49 605.00	-PFG 0.00	-50 605.00	-PS 0.00	-53 605.00	-RH4 508.00	-54 605.00	-SDH (750 lb.) 882.00	-58 919.00	-TB 320.00	-CR 0.00	-VP 217.00	-D4 1,016.00	-XSD (1000 lb.) 1,205.00																																																																													
SERIES NO.	No-Hub	-HS																																																																																																																					
12704 L.Hand 2" Vent	\$2,978.00	\$3,107.00																																																																																																																					
12714 R.Hand 2" Vent	2,978.00	3,107.00																																																																																																																					
-1 \$134.00	-HD4 \$1,016.00																																																																																																																						
-6 141.00	-HLH4 508.00																																																																																																																						
-6CU 141.00	-HRH4 508.00																																																																																																																						
-10 0.00	-HS 129.00																																																																																																																						
-24 Deduct 260.00	-LH4 508.00																																																																																																																						
-30 0.00	-OR 0.00																																																																																																																						
-30-2 0.00	-PAC 0.00																																																																																																																						
-32 796.00	-PAF 0.00																																																																																																																						
-35 0.00	-PF 0.00																																																																																																																						
-49 605.00	-PFG 0.00																																																																																																																						
-50 605.00	-PS 0.00																																																																																																																						
-53 605.00	-RH4 508.00																																																																																																																						
-54 605.00	-SDH (750 lb.) 882.00																																																																																																																						
-58 919.00	-TB 320.00																																																																																																																						
-CR 0.00	-VP 217.00																																																																																																																						
-D4 1,016.00	-XSD (1000 lb.) 1,205.00																																																																																																																						

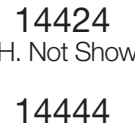

 14064	VERTICAL CLOSE HUB & SPIGOT, ON STACK		
	LIST PRICE		
SERIES NO.			
14064 Sgl., 4" Vent		\$2,360.00	
14104 Sgl., 2" Vent		2,360.00	
 14104	ADD FOR OPTIONS:		
	-1	\$134.00	-SDH (750 lb.)..... 882.00
-6	141.00	-XSD (1000 lb.)..... 1,205.00	
-6CU	141.00	-VP	217.00
-45	605.00		
-46	605.00		

 15964	90° INSTITUTIONAL FITTING VERTICAL NO-HUB, ON STACK		
	LIST PRICE		
SERIES NO.			
15964 Double Waste Fitting with Vent and Carriers		\$7,151.00	
ADD FOR OPTIONS:			
-1	\$264.00	-30-2..... \$0.00	
-6	284.00	-49	605.00
-6CU	284.00	-54	605.00
-10	0.00	-VP	436.00
-24	Deduct 260.00	-XSD (1000 lb.).....	2,410.00
-26	0.00		
-30	0.00		

 14404	VERTICAL CLOSE NO-HUB, OFFSET		
	LIST PRICE		
SERIES NO.			
14404 Sgl. L.H., L.H. 2" Vent		\$2,360.00	
14424 Sgl. R.H., R.H. 2" Vent		2,360.00	
14444 Back-to-Back, 2" Vent		4,041.00	
ADD FOR OPTIONS:			
-1*	\$134.00	-30-2..... \$0.00	
-6*	141.00	-50	605.00
-6CU*	141.00	-54	605.00
-10	0.00	-SDH (750 lb.).....	882.00
-24*	Deduct 260.00	-XSD (1000 lb.).....	1,205.00
-30	0.00	-VP*	217.00
* Pricing for options is per fixture. Add or subtract twice for Back-to-Back Carriers			
 14424 (R.H. Not Shown)			
 14444			









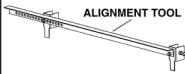

 15984	90° INSTITUTIONAL FITTING VERTICAL NO-HUB, ON STACK		
	LIST PRICE		
SERIES NO.			
15984 Double Waste Fitting, No-Hub Branches, 2" Vent		\$2,722.00	
ADD FOR OPTIONS:			
-26	\$0.00	-54	\$605.00
-49	605.00		

 16123	FLOOR-MOUNT PVC ADAPTER TYPE, ON STACK		
	LIST PRICE		
SERIES NO.			
16123 Single, for PVC Pipe Siphon Jet Closets Only		\$1,700.00	
ADD FOR OPTIONS:			
-1	\$134.00	-13	\$0.00
-6	141.00	-21	542.00
		-VP	217.00

 14464	VERTICAL CLOSE NO-HUB, ON STACK		
	LIST PRICE		
SERIES NO.			
14464 Single, 4" Vent		\$2,360.00	
14484 Back-to-Back, 4" Vent Siphon Jet Closets Only		4,174.00	
ADD FOR OPTIONS:			
-1*	\$134.00	-45	\$605.00
-6*	141.00	-46	605.00
-6CU*	141.00	-SDH (750 lb.).....	882.00
-10	0.00	-VP*	217.00
-24*	Deduct 260.00	-XSD (1000 lb.).....	1,205.00
-30	0.00		
-30-2	0.00		
* Pricing for options is per fixture. Add or subtract twice for Back-to-Back Carriers			
 14484			

Closet Carrier Option Descriptions	
-SDH	Special-Duty 750 lb. Carrier
-XSD	Extra Special-Duty 1,000 lb. Carrier
-VP	Vandal-Proof Trim
-1	Positioning Frame
-6	Supply Pipe Support - Galvanized Pipe
-6CU	Supply Pipe Support - Copper Pipe
-10	ABS Extension through 10-1/2" Wall
-13	3" ABS Fitting Adapter
-21	Hanger Type Closet Adapter
-24	Carrier for Floor-Mounted, Back-Outlet China Bowls
-26	Fitting Anchor Foot
-30	Cast Iron Adjustable Extension with Connector
-30-2	Cast Iron Adjustable Extension with Connector and Test Cap
-45	Threaded Left-Hand Auxiliary Inlet
-46	Threaded Right-Hand Auxiliary Inlet
-49	No-Hub High Auxiliary Inlet, Under Vent
-50	No-Hub High Auxiliary Inlet, Opposite Vent
-54	Threaded High Auxiliary Inlet, Opposite Vent

 14504	VERTICAL CLOSE NO-HUB, ON STACK		
	LIST PRICE		
SERIES NO.			
14504 Single, 2" Vent		\$2,360.00	
ADD FOR OPTIONS:			
-1	\$134.00	-45	\$605.00
-6	141.00	-46	605.00
-6CU	141.00	-SDH (750 lb.).....	882.00
-10	0.00	-VP	217.00
-24	Deduct 260.00	-XSD (1000 lb.).....	1,205.00
-30	0.00		
-30-2	0.00		

 <p>17000</p>	<p>REUSABLE ALIGNMENT TOOL</p> <table border="1"> <thead> <tr> <th colspan="3">LIST PRICE</th> </tr> <tr> <th>TYPE NO.</th> <th>17000</th> <th>\$443.00</th> </tr> </thead> </table>	LIST PRICE			TYPE NO.	17000	\$443.00	 <p>17380</p>	<p>FLOOR-MOUNT ADJUSTABLE EXPOSED ARMS</p> <table border="1"> <thead> <tr> <th colspan="3">LIST PRICE</th> </tr> <tr> <th>TYPE NO.</th> <th>17380</th> <th>17380-BB</th> </tr> </thead> <tbody> <tr> <td></td> <td>\$2,334.00</td> <td>\$3,662.00</td> </tr> <tr> <td colspan="3">ADD FOR OPTIONS:</td> </tr> <tr> <td></td> <td>17380</td> <td>17380-BB</td> </tr> <tr> <td>-10*</td> <td>\$78.00</td> <td>\$160.00</td> </tr> <tr> <td>-60</td> <td>244.00</td> <td>484.00</td> </tr> <tr> <td>-66**</td> <td>Deduct 222.00</td> <td>----</td> </tr> <tr> <td>-BB**</td> <td>1,328.00</td> <td>ABOVE</td> </tr> <tr> <td>-HD</td> <td>276.00</td> <td>552.00</td> </tr> <tr> <td>-VP</td> <td>217.00</td> <td>436.00</td> </tr> </tbody> </table> <p>* Hardware for Walls over 4-1/2", Specify Wall Thickness, Price Per Inch" ** -66 cannot be Furnished with -BB.</p>	LIST PRICE			TYPE NO.	17380	17380-BB		\$2,334.00	\$3,662.00	ADD FOR OPTIONS:				17380	17380-BB	-10*	\$78.00	\$160.00	-60	244.00	484.00	-66**	Deduct 222.00	----	-BB**	1,328.00	ABOVE	-HD	276.00	552.00	-VP	217.00	436.00																											
LIST PRICE																																																																					
TYPE NO.	17000	\$443.00																																																																			
LIST PRICE																																																																					
TYPE NO.	17380	17380-BB																																																																			
	\$2,334.00	\$3,662.00																																																																			
ADD FOR OPTIONS:																																																																					
	17380	17380-BB																																																																			
-10*	\$78.00	\$160.00																																																																			
-60	244.00	484.00																																																																			
-66**	Deduct 222.00	----																																																																			
-BB**	1,328.00	ABOVE																																																																			
-HD	276.00	552.00																																																																			
-VP	217.00	436.00																																																																			
 <p>17100</p>	<p>FLOOR-MOUNT ADJUSTABLE CONCEALED ARMS</p> <table border="1"> <thead> <tr> <th colspan="3">LIST PRICE</th> </tr> <tr> <th>TYPE NO.</th> <th>17100</th> <th>17100-BB</th> </tr> </thead> <tbody> <tr> <td></td> <td>\$1,635.00</td> <td>\$2,331.00</td> </tr> <tr> <td colspan="3">ADD FOR OPTIONS:</td> </tr> <tr> <td></td> <td>17100</td> <td>17100-BB</td> </tr> <tr> <td>-10*</td> <td>\$78.00</td> <td>\$160.00</td> </tr> <tr> <td>-60</td> <td>244.00</td> <td>484.00</td> </tr> <tr> <td>-67</td> <td>110.00</td> <td>222.00</td> </tr> <tr> <td>-75</td> <td>269.00</td> <td>536.00</td> </tr> <tr> <td>-76</td> <td>488.00</td> <td>979.00</td> </tr> <tr> <td>-77</td> <td>488.00</td> <td>979.00</td> </tr> <tr> <td>-BB</td> <td>695.00</td> <td>ABOVE</td> </tr> <tr> <td>-S**</td> <td>----</td> <td>0.00</td> </tr> <tr> <td>-T**</td> <td>----</td> <td>159.00</td> </tr> <tr> <td>-U**</td> <td>----</td> <td>316.00</td> </tr> <tr> <td>-V**</td> <td>----</td> <td>477.00</td> </tr> <tr> <td>-W**</td> <td>----</td> <td>635.00</td> </tr> <tr> <td>-X**</td> <td>----</td> <td>794.00</td> </tr> <tr> <td>-Y**</td> <td>----</td> <td>953.00</td> </tr> <tr> <td>-Z**</td> <td>----</td> <td>1,113.00</td> </tr> </tbody> </table> <p>*Extension Sleeves Longer than 6-1/2", Specify Wall Thickness, Price Per Inch **Wall Thickness (inches) Suffix Wall Thickness (inches) Suffix 4-1/2 to 5 S 8-1/16 to 9 W 5-1/16 to 6 T 9-1/16 to 10 X 6-1/16 to 7 U 10-1/16 to 11 Y 7-1/16 to 8 V 11-1/16 to 12 Z</p>	LIST PRICE			TYPE NO.	17100	17100-BB		\$1,635.00	\$2,331.00	ADD FOR OPTIONS:				17100	17100-BB	-10*	\$78.00	\$160.00	-60	244.00	484.00	-67	110.00	222.00	-75	269.00	536.00	-76	488.00	979.00	-77	488.00	979.00	-BB	695.00	ABOVE	-S**	----	0.00	-T**	----	159.00	-U**	----	316.00	-V**	----	477.00	-W**	----	635.00	-X**	----	794.00	-Y**	----	953.00	-Z**	----	1,113.00	 <p>17390</p>	<p>WALL-MOUNT ADJUSTABLE EXPOSED ARMS</p> <table border="1"> <thead> <tr> <th colspan="3">LIST PRICE</th> </tr> <tr> <th>TYPE NO.</th> <th>17390</th> <th>\$1,623.00</th> </tr> </thead> </table> <p>ADD FOR OPTIONS:</p> <p>-10*.....\$78.00 -BP.....\$0.00 -VP.....\$217.00</p> <p>* Hardware for Walls over 4-1/2", Specify Wall Thickness, Price Per Inch"</p>	LIST PRICE			TYPE NO.	17390	\$1,623.00
LIST PRICE																																																																					
TYPE NO.	17100	17100-BB																																																																			
	\$1,635.00	\$2,331.00																																																																			
ADD FOR OPTIONS:																																																																					
	17100	17100-BB																																																																			
-10*	\$78.00	\$160.00																																																																			
-60	244.00	484.00																																																																			
-67	110.00	222.00																																																																			
-75	269.00	536.00																																																																			
-76	488.00	979.00																																																																			
-77	488.00	979.00																																																																			
-BB	695.00	ABOVE																																																																			
-S**	----	0.00																																																																			
-T**	----	159.00																																																																			
-U**	----	316.00																																																																			
-V**	----	477.00																																																																			
-W**	----	635.00																																																																			
-X**	----	794.00																																																																			
-Y**	----	953.00																																																																			
-Z**	----	1,113.00																																																																			
LIST PRICE																																																																					
TYPE NO.	17390	\$1,623.00																																																																			
 <p>17120</p>	<p>WALL-MOUNT ADJUSTABLE CONCEALED ARMS</p> <table border="1"> <thead> <tr> <th colspan="3">LIST PRICE</th> </tr> <tr> <th>TYPE NO.</th> <th>17120</th> <th>\$967.00</th> </tr> </thead> </table> <p>ADD FOR OPTIONS:</p> <p>-10*.....\$78.00 -77.....\$488.00 -67.....110.00 -BB.....0.00 -75.....269.00 -MMB.....Deduct 203.00 -76.....488.00</p> <p>* Extension Sleeves Longer than 4", Specify Wall Thickness, Price Per Inch</p>	LIST PRICE			TYPE NO.	17120	\$967.00	 <p>17405</p>	<p>WALL-MOUNT EXPOSED ARMS ONLY</p> <table border="1"> <thead> <tr> <th colspan="3">LIST PRICE</th> </tr> <tr> <th>TYPE NO.</th> <th>17405</th> <th>\$1,048.00</th> </tr> </thead> </table> <p>ADD FOR OPTIONS:</p> <p>-10*.....\$78.00 -7VP.....\$217.00</p> <p>* Hardware for Walls over 4-1/2", Specify Wall Thickness, Price Per Inch"</p>	LIST PRICE			TYPE NO.	17405	\$1,048.00																																																						
LIST PRICE																																																																					
TYPE NO.	17120	\$967.00																																																																			
LIST PRICE																																																																					
TYPE NO.	17405	\$1,048.00																																																																			
 <p>17125</p>	<p>WALL-MOUNT, NON-ADJUSTABLE CONCEALED ARMS</p> <table border="1"> <thead> <tr> <th colspan="3">LIST PRICE</th> </tr> <tr> <th>TYPE NO.</th> <th>17125</th> <th>\$753.00</th> </tr> </thead> </table> <p>ADD FOR OPTIONS:</p> <p>-10*.....\$78.00 -75.....\$269.00</p> <p>* Extension Sleeves Longer than 4", Specify Wall Thickness, Price Per Inch</p>	LIST PRICE			TYPE NO.	17125	\$753.00	 <p>17550</p>	<p>FLOOR-MOUNT HANGER PLATE TYPE</p> <table border="1"> <thead> <tr> <th colspan="4">LIST PRICE</th> </tr> <tr> <th>17550</th> <th>17550-BB</th> <th>17550-UR</th> <th>17550-WCBL</th> </tr> </thead> <tbody> <tr> <td>\$1,238.00</td> <td>\$1,635.00</td> <td>\$1,238.00</td> <td>\$2,029.00</td> </tr> <tr> <td colspan="4">ADD FOR OPTIONS:</td> </tr> <tr> <td></td> <td>17550</td> <td>17550-BB</td> <td></td> </tr> <tr> <td>-10*</td> <td>\$78.00</td> <td>\$160.00</td> <td></td> </tr> <tr> <td>-60</td> <td>244.00</td> <td>484.00</td> <td></td> </tr> <tr> <td>-BB</td> <td>399.00</td> <td>ABOVE</td> <td></td> </tr> <tr> <td>-CL</td> <td>509.00</td> <td>----</td> <td></td> </tr> <tr> <td>-UR**</td> <td>0.00</td> <td>----</td> <td></td> </tr> <tr> <td>-WC**</td> <td>0.00</td> <td>----</td> <td></td> </tr> <tr> <td>-WCBL**</td> <td>790.00</td> <td>----</td> <td></td> </tr> </tbody> </table> <p>* Hardware for Walls over 4", Specify Wall Thickness, Price Per Inch ** Cannot be Furnished with -60</p>	LIST PRICE				17550	17550-BB	17550-UR	17550-WCBL	\$1,238.00	\$1,635.00	\$1,238.00	\$2,029.00	ADD FOR OPTIONS:					17550	17550-BB		-10*	\$78.00	\$160.00		-60	244.00	484.00		-BB	399.00	ABOVE		-CL	509.00	----		-UR**	0.00	----		-WC**	0.00	----		-WCBL**	790.00	----													
LIST PRICE																																																																					
TYPE NO.	17125	\$753.00																																																																			
LIST PRICE																																																																					
17550	17550-BB	17550-UR	17550-WCBL																																																																		
\$1,238.00	\$1,635.00	\$1,238.00	\$2,029.00																																																																		
ADD FOR OPTIONS:																																																																					
	17550	17550-BB																																																																			
-10*	\$78.00	\$160.00																																																																			
-60	244.00	484.00																																																																			
-BB	399.00	ABOVE																																																																			
-CL	509.00	----																																																																			
-UR**	0.00	----																																																																			
-WC**	0.00	----																																																																			
-WCBL**	790.00	----																																																																			
 <p>17125-UP-ADJ</p>	<p>PRE-ASSEMBLED CARRIER, FLOOR-MOUNT ADJUSTABLE CONCEALED ARMS</p> <table border="1"> <thead> <tr> <th colspan="3">LIST PRICE</th> </tr> <tr> <th>TYPE NO.</th> <th>17125-UP-ADJ</th> <th>\$2,133.00</th> </tr> </thead> </table> <p>ADD FOR OPTIONS:</p> <p>-10*.....\$78.00 -75.....\$269.00</p> <p>* Extension Sleeves Longer than 4", Specify Wall Thickness, Price Per Inch</p>	LIST PRICE			TYPE NO.	17125-UP-ADJ	\$2,133.00	<p>Fixture Carrier Option Descriptions</p> <table border="0"> <tbody> <tr> <td>-BB</td> <td>Back-to-Back Carrier</td> <td>-60</td> <td>Valve Plate for Attaching to Upright</td> </tr> <tr> <td>-BP</td> <td>with Back Plates</td> <td>-66</td> <td>Split Header for Stainless Steel Arms</td> </tr> <tr> <td>-CL</td> <td>Corner Lavatory Carrier</td> <td>-67</td> <td>Concealed Arm Carrier for Wheelchair Lavatory</td> </tr> <tr> <td>-HD</td> <td>Heavy-Duty</td> <td>-75</td> <td>2" Chrome Plated Escutcheons</td> </tr> <tr> <td>-MMB</td> <td>with Movable Mounting Brackets</td> <td>-76</td> <td>4" Chrome Plated Escutcheons</td> </tr> <tr> <td>-UR</td> <td>Urinal Carrier</td> <td>-77</td> <td>6" Chrome Plated Escutcheons</td> </tr> <tr> <td>-VP</td> <td>Vandal-Proof Trim</td> <td>-58</td> <td>Horizontal No-Hub Cast Long Barrel</td> </tr> <tr> <td>-WC</td> <td>Water Cooler Carrier</td> <td></td> <td></td> </tr> <tr> <td>-WCBL</td> <td>Water Cooler Bi-Level Carrier</td> <td></td> <td></td> </tr> <tr> <td>-10</td> <td>Extension Sleeves or Hardware for Thicker Walls, See Product No-Hub Branch</td> <td></td> <td></td> </tr> </tbody> </table>		-BB	Back-to-Back Carrier	-60	Valve Plate for Attaching to Upright	-BP	with Back Plates	-66	Split Header for Stainless Steel Arms	-CL	Corner Lavatory Carrier	-67	Concealed Arm Carrier for Wheelchair Lavatory	-HD	Heavy-Duty	-75	2" Chrome Plated Escutcheons	-MMB	with Movable Mounting Brackets	-76	4" Chrome Plated Escutcheons	-UR	Urinal Carrier	-77	6" Chrome Plated Escutcheons	-VP	Vandal-Proof Trim	-58	Horizontal No-Hub Cast Long Barrel	-WC	Water Cooler Carrier			-WCBL	Water Cooler Bi-Level Carrier			-10	Extension Sleeves or Hardware for Thicker Walls, See Product No-Hub Branch																						
LIST PRICE																																																																					
TYPE NO.	17125-UP-ADJ	\$2,133.00																																																																			
-BB	Back-to-Back Carrier	-60	Valve Plate for Attaching to Upright																																																																		
-BP	with Back Plates	-66	Split Header for Stainless Steel Arms																																																																		
-CL	Corner Lavatory Carrier	-67	Concealed Arm Carrier for Wheelchair Lavatory																																																																		
-HD	Heavy-Duty	-75	2" Chrome Plated Escutcheons																																																																		
-MMB	with Movable Mounting Brackets	-76	4" Chrome Plated Escutcheons																																																																		
-UR	Urinal Carrier	-77	6" Chrome Plated Escutcheons																																																																		
-VP	Vandal-Proof Trim	-58	Horizontal No-Hub Cast Long Barrel																																																																		
-WC	Water Cooler Carrier																																																																				
-WCBL	Water Cooler Bi-Level Carrier																																																																				
-10	Extension Sleeves or Hardware for Thicker Walls, See Product No-Hub Branch																																																																				
 <p>17140</p>	<p>NON-ADJUSTABLE, CONCEALED ARMS w/WELDED SLEEVES FOR BLOCK WALL MOUNT</p> <table border="1"> <thead> <tr> <th colspan="3">LIST PRICE</th> </tr> <tr> <th>TYPE NO.</th> <th>17140</th> <th>\$760.00</th> </tr> </thead> </table> <p>ADD FOR OPTIONS:</p> <p>-75.....\$269.00</p>	LIST PRICE			TYPE NO.	17140	\$760.00																																																														
LIST PRICE																																																																					
TYPE NO.	17140	\$760.00																																																																			

17560

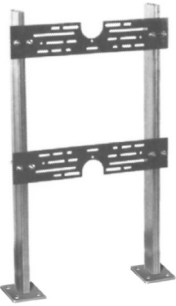

FLOOR-MOUNT BEARING PLATE TYPE

LIST PRICE			
17560	17560-BB	17560-UR 17560-WC	17560- WCBL
\$1,381.00	\$1,929.00	1,381.00	\$2,168.00

ADD FOR OPTIONS:

	17560	17560-BB
-10*	\$78.00	\$160.00
-60	244.00	484.00
-BB	550.00	ABOVE
-UR**	0.00	----
-WC**	0.00	----
-WCBL**	790.00	----

* Hardware for Walls over 4", Specify Wall Thickness, Price Per Inch
** Cannot be Furnished with -60

17590

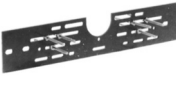

WALL-MOUNT HANGER PLATE TYPE

LIST PRICE		
17590	17590-DP	17590-UR
\$342.00	\$420.00	\$342.00

ADD FOR OPTIONS:

-10*.....	\$78.00	-DP.....	\$78.00
		-UR.....	0.00

* Hardware for Walls over 7" for 17590 or 4" for 17590-DP and 17590 -UR-DP, Specify Wall Thickness, Price Per Inch

17720



FLOOR-MOUNT HEAVY-DUTY PLATE TYPE

LIST PRICE		
TYPE NO.	17720	\$4,203.00

ADD FOR OPTIONS:

-10*.....	\$164.00	-VP.....	\$217.00
-66.....	Ded. 244.00		

* Hardware for Walls over 4", Specify Wall Thickness, Price Per Inch

17730



FLOOR-MOUNT w/ADJUSTABLE COUPLING

LIST PRICE		
TYPE NO.	17730	\$1,978.00

ADD FOR OPTIONS:

-11.....	\$0.00	-VP.....	\$217.00
-60.....	244.00		

17735

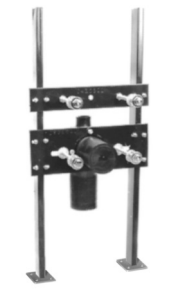

FLOOR-MOUNT w/FITTING

LIST PRICE		
TYPE NO.	17735	\$3,278.00

ADD FOR OPTIONS:

-10.....	\$0.00	-60.....	\$244.00
-45.....	605.00	-VP.....	217.00
-46.....	605.00		

* Hardware for Walls over 5-3/8", Specify Wall Thickness, Price Per Inch
NOTE: Other Fittings Available on Request. Contact your Josam Representative.

- Fixture Carrier Option Descriptions**
- BB Back-to-Back Carrier
 - DP Double Plate Carrier
 - UR Urinal Carrier
 - VP Vandal-Proof Trim
 - WC Water Cooler Carrier
 - WCBL Water Cooler Bi-Level Carrier
 - 10 Hardware for Thicker Walls
 - 11 Cast Iron Adjustable Extension through 12" Length, Specify 6", 9" or 12" on Order
 - 45 Threaded High Left-Hand Auxiliary Vent
 - 46 Threaded High Right-Hand Auxiliary Vent
 - 60 Valve Plate for Attaching to Upright
 - 66 Split Header for Stainless Steel Arms

ROOF DRAINS

21500



15" DOME, LARGE SUMP

LIST PRICE				
PIPE SIZE	21500	21500-AE	21500-16	21500-AE-16
2", 3", 4"	1,174.00	\$2,348.00	\$1,870.00	\$3,045.00
5", 6"	1,677.00	2,852.00	2,374.00	3,546.00
8"	2,176.00	3,350.00	2,872.00	N/A
10"	3,434.00	4,607.00	N/A	N/A

ADD FOR OPTIONS:

-1.....	\$402.00	-20.....	\$1,587.00	-FG.....	\$1,140.00
-2.....	453.00	-21-22.....	1,029.00	-FG2.....	1,365.00
-3.....	851.00	-22.....	345.00	-FG3.....	1,844.00
-3C.....	610.00	-23.....	1,376.00	-OR.....	1,174.00
-4.....	310.00	-26.....	405.00	-PFB.....	1,086.00
-6.....	2,184.00	-33.....	831.00	-T.....	129.00
-10*	1,096.00	-66.....	612.00	-VP.....	205.00
-10-20*	1,737.00	-AE.....	1,174.00	-X.....	0.00
-16 ∅.....	696.00	-AER.....	539.00	-Y.....	0.00
-17 (2") ∅.....	380.00	-ARE.....	2,254.00	-YGTC (2"-4").....	41.00
-17 (4") ∅.....	760.00	-IRMA.....	1,302.00	-Z.....	0.00
-19.....	1,302.00	-CR.....	694.00		

* Specify Height, Price Each 4" or Fraction
∅ -16 and -17 cannot be furnished together

GREEN ROOF DRAINS

21500-RDG

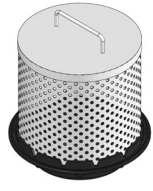



















LIST PRICE				
PIPE SIZE	21500-RDG1	21500-RDG2	21500-RDG3	21500-ORDG1
2", 3", 4"	\$6,388.00	\$6,025.00	\$6,198.00	\$6,388.00
5", 6"	6,887.00	6,524.00	6,701.00	6,887.00
8"	7,390.00	7,027.00	7,199.00	7,388.00









ADD FOR OPTIONS:

-1.....	\$402.00	-21.....	\$683.00	-CR.....	\$694.00
-2.....	453.00	-22.....	345.00	-OR.....	1,174.00
-3.....	851.00	-23.....	1,376.00	-PC.....	0.00
-3C.....	610.00	-26.....	405.00	-T.....	129.00
-4.....	310.00	-33.....	831.00	-VP.....	205.00
-6.....	2,184.00	-66.....	612.00	-X.....	0.00
-10*	1,096.00	-AE.....	1,174.00	-Y.....	0.00
-10-20*.....	1,737.00	-AER.....	539.00	-YGTC (2"-4").....	41.00
-17.....	380.00	-AI.....	1,481.00	-Z.....	0.00
-20.....	1,587.00	-ARE.....	2,254.00		

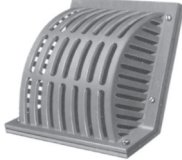
* Specify Height, Price Each 4" or Fraction

	22010 12" BEEHIVE DOME, MEDIUM SUMP				23500 14" PROMENADE TOP, LARGE SUMP				
	LIST PRICE				LIST PRICE				
PIPE SIZE		2" - 6"	\$1,038.00	PIPE SIZE		23500	23500-AE	23500-6	23500-IRMA
ADD FOR OPTIONS:									
-1		\$246.00	-19		\$1,038.00	-FG		\$572.00	
-2		426.00	-20		647.00	-IRMA†		770.00	
-3		673.00	-21		263.00	-T		129.00	
-3C		587.00	-23		673.00	-VP		188.00	
-10*		146.00	-26		298.00	-X		0.00	
-10-20*		288.00	-66		263.00	-Z		0.00	
-17 (2")		312.00	-AER		838.00				
-17 (4")		624.00	-ARE		1,764.00				
* Specify Height, Price Per Inch † Price up to 4". Each additional inch, add \$127.00.									
	22080 9" HIGH DOME, SMALL SUMP								
	LIST PRICE								
PIPE SIZE		2", 3", 4"	\$874.00						
ADD FOR OPTIONS:									
-1		\$246.00	-20		\$333.00	-IRMA†		\$770.00	
-2		426.00	-21		131.00	-PFB		1,086.00	
-3		673.00	-23		551.00	-T		129.00	
-3C		563.00	-26		298.00	-TSO ♦		309.00	
-10*		146.00	-33		500.00	-VP		188.00	
-10-20*		288.00	-66		257.00	-X		0.00	
-17 (2")		312.00	-AER		838.00	-Y		0.00	
-17 (4")		624.00	-ARE		1,268.00	-YGTC (2"-4")		41.00	
-19		770.00	-FG		488.00	-Z		0.00	
* Specify Height, Price Per Inch † Price up to 4". Each additional inch, add \$127.00. ♦ Cannot be used with Drain Receiver									
	22100 COMBINATION DRAIN/OVERFLOW, SMALL SUMP w/CI DOME								
	LIST PRICE								
PIPE SIZE		3", 4"	\$1,208.00						
ADD FOR OPTIONS:									
-1		\$568.00	-23		\$551.00	-VP		\$374.00	
-10*		288.00	-33		931.00	-Z		0.00	
-20		663.00	-IRMA		1,531.00				
*Specify Height, Price Per Inch									
	22200 COMBINATION DRAIN/OVERFLOW, MEDIUM SUMP w/CI DOME								
	LIST PRICE								
PIPE SIZE		2" - 6"	\$3,220.00						
ADD FOR OPTIONS:									
-10*		\$288.00	-33		\$1,549.00	-T		\$261.00	
-10-20*		590.00	-66		257.00	-VP		374.00	
-20		1,294.00	-IRMA		2,072.00	-X		0.00	
-23		1,347.00	-RCSD		\$0.00	-Z		0.00	
*Specify Height, Price Per Inch									
	22500 COMBINATION DRAIN/OVERFLOW, LARGE SUMP AND POLY DOME								
	LIST PRICE								
PIPE SIZE		2", 3", 4"	5", 6"	8"					
		\$4,125.00	\$5,130.00	\$6,133.00					
ADD FOR OPTIONS:									
-1		\$804.00	-23		\$2,750.00	-RCSD		\$0.00	
-4		616.00	-26		815.00	-VP		411.00	
-10*		2,187.00	-33		1,664.00	-T		261.00	
-10-20*		3,473.00	-66		1,231.00	-X		0.00	
-20		3,176.00	-AE		2,357.00	-YGTC (2"-4")		41.00	
-21-22		1,905.00	-AER		659.00	-Y		0.00	
-22		694.00	-IRMA		2,613.00	-Z		0.00	
*Specify Height, Price Each 4" or Fraction.									
Roof Drain Option Descriptions									
-AE		LEVELEZE® Adjustable Extension							
-AER		Adjustable Extension using Threaded Rods and Hardware							
-ARE		Acid-Resisting Epoxy							
-CR		Clamping Drain Receiver							
-FG		Flat Cast Iron Grate							
-FG2		ADA/HP Flat Grate							
-FG3		ADA/HP Flat Grate							
-IRMA		Perforated Stainless Steel Extension							
-OR		LEVELEZE® Adjustable Extension with O-Ring							
-PC		Perforated Cover							
-PG		PARKING GRATE							
-RCSD		Recessed Drain Receiver							
-VP		Vandal-Proof Dome or Grate							
-1		Deck Clamp Assembly							
-2		Drain Receiver							
-3		Deck Clamp Assembly and Drain Receiver							
-3C		Drain Receiver and Drain Receiver Clips							
-4		Secondary Flashing Clamp (use with -AE Only)							
-6		Extra Wide Flange Drain Body (2" through 6", -X Only)							
-10		Fixed Extended Collar, Cast Iron							
-10-20		Fixed Extended Collar, Galvanized							
-16		Internal Water Guard 2-6" Outlets Only							
-17		2" High Solid Clamping Collar							
-18		Extra Deep Sump							
-19		Clamp Collar w/Perforated SS Gravel Guard							
-20		Galvanized Cast Iron Parts							
-21		Galvanized Cast Iron Dome Only							
-22		Cast Iron Dome							
-23		Rough Bronze Dome							
-26		Aluminum Dome							
-33		Stainless Mesh Screen-Covered Dome							
-36		Ductile Iron Grate (Cast Iron Top Only)							
-37-50		HD Ductile Iron Undergrate Laminated Top, Satin Finish Nikaloy							
-37-51		HD Ductile Iron Undergrate Laminated Top, Satin Finish Bronze							
-50		C.I. Undergrate Laminated Top, Satin Finish Nikaloy							
-51		C.I. Undergrate Laminated Top, Satin Finish Bronze							
Outlets									
-66		No-Hub Side Outlet, 2"- 6"							
-T		Threaded Outlet							
-TSO		Threaded Side Outlet							
-X		Inside Caulk Outlet							
-Y		Hub Outlet w/Gasket, 2"-4"							
-YGTC		-Y Outlet Gasket with Test Cap							
-Z		No-Hub Spigot Outlet							

 <p>23510</p>	<p>15" EXTRA HEAVY-DUTY PARKING GRATE, LARGE SUMP</p> <table border="1"> <thead> <tr> <th colspan="4">LIST PRICE</th> </tr> <tr> <th>PIPE SIZE</th> <th>2", 3", 4"</th> <th>5", 6"</th> <th>8"</th> </tr> </thead> <tbody> <tr> <td></td> <td>\$2,586.00</td> <td>\$3,065.00</td> <td>\$3,659.00</td> </tr> </tbody> </table> <p>ADD FOR OPTIONS:</p> <table border="1"> <tbody> <tr> <td>-1</td><td>\$402.00</td> <td>-20</td><td>\$1,471.00</td> <td>-T</td><td>\$129.00</td> </tr> <tr> <td>-2</td><td>452.00</td> <td>-36</td><td>1,015.00</td> <td>-VP</td><td>240.00</td> </tr> <tr> <td>-3</td><td>851.00</td> <td>-50</td><td>4,261.00</td> <td>-X</td><td>0.00</td> </tr> <tr> <td>-3C</td><td>610.00</td> <td>-51</td><td>3,825.00</td> <td>-Y</td><td>0.00</td> </tr> <tr> <td>-10*</td><td>1,174.00</td> <td>-66</td><td>612.00</td> <td>-YGTC (2"-4")</td><td>41.00</td> </tr> <tr> <td>-10-20*</td><td>1,654.00</td> <td>-CR</td><td>694.00</td> <td>-Z</td><td>0.00</td> </tr> </tbody> </table> <p>* Specify Height, Price Each 4" or Fraction</p>	LIST PRICE				PIPE SIZE	2", 3", 4"	5", 6"	8"		\$2,586.00	\$3,065.00	\$3,659.00	-1	\$402.00	-20	\$1,471.00	-T	\$129.00	-2	452.00	-36	1,015.00	-VP	240.00	-3	851.00	-50	4,261.00	-X	0.00	-3C	610.00	-51	3,825.00	-Y	0.00	-10*	1,174.00	-66	612.00	-YGTC (2"-4")	41.00	-10-20*	1,654.00	-CR	694.00	-Z	0.00	 <p>24030</p>	<p>13" SUPER-FLO® TOP, MEDIUM SUMP COMPOSITION DECK FLANGE</p> <table border="1"> <thead> <tr> <th colspan="3">LIST PRICE</th> </tr> <tr> <th>PIPE SIZE</th> <th>4", 5", 6", 8"</th> <th>\$2,948.00</th> </tr> </thead> </table> <p>ADD FOR OPTIONS:</p> <table border="1"> <tbody> <tr> <td>-1</td><td>\$373.00</td> <td>-31</td><td>\$188.00</td> <td>-66</td><td>\$257.00</td> </tr> <tr> <td>-20</td><td>1,325.00</td> <td>-36</td><td>436.00</td> <td>-HP</td><td>176.00</td> </tr> <tr> <td>-29</td><td>401.00</td> <td>-50</td><td>1,197.00</td> <td>-VP</td><td>245.00</td> </tr> <tr> <td>-29-20</td><td>731.00</td> <td>-51</td><td>1,089.00</td> <td>-X</td><td>0.00</td> </tr> </tbody> </table>	LIST PRICE			PIPE SIZE	4", 5", 6", 8"	\$2,948.00	-1	\$373.00	-31	\$188.00	-66	\$257.00	-20	1,325.00	-36	436.00	-HP	176.00	-29	401.00	-50	1,197.00	-VP	245.00	-29-20	731.00	-51	1,089.00	-X	0.00			
LIST PRICE																																																																																				
PIPE SIZE	2", 3", 4"	5", 6"	8"																																																																																	
	\$2,586.00	\$3,065.00	\$3,659.00																																																																																	
-1	\$402.00	-20	\$1,471.00	-T	\$129.00																																																																															
-2	452.00	-36	1,015.00	-VP	240.00																																																																															
-3	851.00	-50	4,261.00	-X	0.00																																																																															
-3C	610.00	-51	3,825.00	-Y	0.00																																																																															
-10*	1,174.00	-66	612.00	-YGTC (2"-4")	41.00																																																																															
-10-20*	1,654.00	-CR	694.00	-Z	0.00																																																																															
LIST PRICE																																																																																				
PIPE SIZE	4", 5", 6", 8"	\$2,948.00																																																																																		
-1	\$373.00	-31	\$188.00	-66	\$257.00																																																																															
-20	1,325.00	-36	436.00	-HP	176.00																																																																															
-29	401.00	-50	1,197.00	-VP	245.00																																																																															
-29-20	731.00	-51	1,089.00	-X	0.00																																																																															
 <p>23710</p>	<p>11" PROMENADE TOP, MEDIUM SUMP</p> <table border="1"> <thead> <tr> <th colspan="3">LIST PRICE</th> </tr> <tr> <th>PIPE SIZE</th> <th>2"- 6"</th> <th>\$1,786.00</th> </tr> </thead> </table> <p>ADD FOR OPTIONS:</p> <table border="1"> <tbody> <tr> <td>-1</td><td>\$246.00</td> <td>-20</td><td>\$830.00</td> <td>-T</td><td>\$129.00</td> </tr> <tr> <td>-2</td><td>416.00</td> <td>-50</td><td>1,219.00</td> <td>-VP</td><td>240.00</td> </tr> <tr> <td>-3</td><td>663.00</td> <td>-51</td><td>1,063.00</td> <td>-X</td><td>0.00</td> </tr> <tr> <td>-3C</td><td>574.00</td> <td>-66</td><td>257.00</td> <td>-Z</td><td>0.00</td> </tr> <tr> <td>-12*</td><td>146.00</td> <td>-IRMA†</td><td>770.00</td> <td></td><td></td> </tr> </tbody> </table> <p>* Specify Height, Price Per Inch † Price up to 4" Each additional inch, add \$127.00.</p>	LIST PRICE			PIPE SIZE	2"- 6"	\$1,786.00	-1	\$246.00	-20	\$830.00	-T	\$129.00	-2	416.00	-50	1,219.00	-VP	240.00	-3	663.00	-51	1,063.00	-X	0.00	-3C	574.00	-66	257.00	-Z	0.00	-12*	146.00	-IRMA†	770.00			 <p>24040</p>	<p>9" SUPER-FLO® TOP, MEDIUM SUMP COMPOSITION DECK FLANGE</p> <table border="1"> <thead> <tr> <th colspan="3">LIST PRICE</th> </tr> <tr> <th>PIPE SIZE</th> <th>2", 3", 4"</th> <th>\$1,666.00</th> </tr> </thead> </table> <p>ADD FOR OPTIONS:</p> <table border="1"> <tbody> <tr> <td>-1</td><td>\$246.00</td> <td>-36</td><td>\$345.00</td> <td>-HP</td><td>176.00</td> </tr> <tr> <td>-20</td><td>993.00</td> <td>-38</td><td>Ded.148.00</td> <td>-VP</td><td>245.00</td> </tr> <tr> <td>-29</td><td>228.00</td> <td>-50</td><td>831.00</td> <td>-X</td><td>0.00</td> </tr> <tr> <td>-29-20</td><td>342.00</td> <td>-51</td><td>683.00</td> <td></td><td></td> </tr> <tr> <td>-31</td><td>188.00</td> <td>-66</td><td>257.00</td> <td></td><td></td> </tr> </tbody> </table>	LIST PRICE			PIPE SIZE	2", 3", 4"	\$1,666.00	-1	\$246.00	-36	\$345.00	-HP	176.00	-20	993.00	-38	Ded.148.00	-VP	245.00	-29	228.00	-50	831.00	-X	0.00	-29-20	342.00	-51	683.00			-31	188.00	-66	257.00											
LIST PRICE																																																																																				
PIPE SIZE	2"- 6"	\$1,786.00																																																																																		
-1	\$246.00	-20	\$830.00	-T	\$129.00																																																																															
-2	416.00	-50	1,219.00	-VP	240.00																																																																															
-3	663.00	-51	1,063.00	-X	0.00																																																																															
-3C	574.00	-66	257.00	-Z	0.00																																																																															
-12*	146.00	-IRMA†	770.00																																																																																	
LIST PRICE																																																																																				
PIPE SIZE	2", 3", 4"	\$1,666.00																																																																																		
-1	\$246.00	-36	\$345.00	-HP	176.00																																																																															
-20	993.00	-38	Ded.148.00	-VP	245.00																																																																															
-29	228.00	-50	831.00	-X	0.00																																																																															
-29-20	342.00	-51	683.00																																																																																	
-31	188.00	-66	257.00																																																																																	
 <p>23730</p>	<p>9" PROMENADE TOP, SMALL SUMP</p> <table border="1"> <thead> <tr> <th colspan="3">LIST PRICE</th> </tr> <tr> <th>PIPE SIZE</th> <th>2", 3", 4"</th> <th>\$1,359.00</th> </tr> </thead> </table> <p>ADD FOR OPTIONS:</p> <table border="1"> <tbody> <tr> <td>-1</td><td>\$246.00</td> <td>-20</td><td>\$441.00</td> <td>-TSO ◊</td><td>\$309.00</td> </tr> <tr> <td>-2</td><td>416.00</td> <td>-50</td><td>707.00</td> <td>-VP</td><td>240.00</td> </tr> <tr> <td>-3</td><td>663.00</td> <td>-51</td><td>633.00</td> <td>-X</td><td>0.00</td> </tr> <tr> <td>-3C</td><td>551.00</td> <td>-66</td><td>257.00</td> <td>-Y</td><td>0.00</td> </tr> <tr> <td>-12*</td><td>146.00</td> <td>-IRMA†</td><td>770.00</td> <td>-YGTC (2"-4")</td><td>41.00</td> </tr> <tr> <td>-12-20*</td><td>288.00</td> <td>-T</td><td>129.00</td> <td>-Z</td><td>0.00</td> </tr> </tbody> </table> <p>* Specify Height, Price Per Inch † Price up to 4" Each additional inch, add \$127.00. ◊ Cannot be used with Drain Receiver</p>	LIST PRICE			PIPE SIZE	2", 3", 4"	\$1,359.00	-1	\$246.00	-20	\$441.00	-TSO ◊	\$309.00	-2	416.00	-50	707.00	-VP	240.00	-3	663.00	-51	633.00	-X	0.00	-3C	551.00	-66	257.00	-Y	0.00	-12*	146.00	-IRMA†	770.00	-YGTC (2"-4")	41.00	-12-20*	288.00	-T	129.00	-Z	0.00	 <p>24050</p>	<p>GARAGE DRAIN, 13" SPECIAL-DUTY TOP, WIDE FLANGE</p> <table border="1"> <thead> <tr> <th colspan="3">LIST PRICE</th> </tr> <tr> <th>PIPE SIZE</th> <th>4"- 6"</th> <th>8"</th> </tr> </thead> <tbody> <tr> <td></td> <td>\$4,191.00</td> <td>\$4,682.00</td> </tr> </tbody> </table> <p>ADD FOR OPTIONS:</p> <table border="1"> <tbody> <tr> <td>-1</td><td>\$373.00</td> <td>-29-20</td><td>\$737.00</td> <td>-51</td><td>\$1,786.00</td> </tr> <tr> <td>-12*</td><td>146.00</td> <td>-31</td><td>188.00</td> <td>-66</td><td>257.00</td> </tr> <tr> <td>-20</td><td>1,802.00</td> <td>-36</td><td>436.00</td> <td>-HP</td><td>176.00</td> </tr> <tr> <td>-29</td><td>342.00</td> <td>-50</td><td>2,174.00</td> <td>-VP</td><td>245.00</td> </tr> <tr> <td></td><td></td> <td></td><td></td> <td>-X</td><td>0.00</td> </tr> </tbody> </table> <p>* Specify Height, Price Per Inch</p>	LIST PRICE			PIPE SIZE	4"- 6"	8"		\$4,191.00	\$4,682.00	-1	\$373.00	-29-20	\$737.00	-51	\$1,786.00	-12*	146.00	-31	188.00	-66	257.00	-20	1,802.00	-36	436.00	-HP	176.00	-29	342.00	-50	2,174.00	-VP	245.00					-X	0.00
LIST PRICE																																																																																				
PIPE SIZE	2", 3", 4"	\$1,359.00																																																																																		
-1	\$246.00	-20	\$441.00	-TSO ◊	\$309.00																																																																															
-2	416.00	-50	707.00	-VP	240.00																																																																															
-3	663.00	-51	633.00	-X	0.00																																																																															
-3C	551.00	-66	257.00	-Y	0.00																																																																															
-12*	146.00	-IRMA†	770.00	-YGTC (2"-4")	41.00																																																																															
-12-20*	288.00	-T	129.00	-Z	0.00																																																																															
LIST PRICE																																																																																				
PIPE SIZE	4"- 6"	8"																																																																																		
	\$4,191.00	\$4,682.00																																																																																		
-1	\$373.00	-29-20	\$737.00	-51	\$1,786.00																																																																															
-12*	146.00	-31	188.00	-66	257.00																																																																															
-20	1,802.00	-36	436.00	-HP	176.00																																																																															
-29	342.00	-50	2,174.00	-VP	245.00																																																																															
				-X	0.00																																																																															
 <p>23740</p>	<p>8" HEAVY-DUTY TOP, MEDIUM SUMP</p> <table border="1"> <thead> <tr> <th colspan="3">LIST PRICE</th> </tr> <tr> <th>PIPE SIZE</th> <th>2", 3", 4"</th> <th>\$3,452.00</th> </tr> </thead> </table> <p>ADD FOR OPTIONS:</p> <table border="1"> <tbody> <tr> <td>-1</td><td>\$246.00</td> <td>-20</td><td>\$475.00</td> <td>-VP</td><td>240.00</td> </tr> <tr> <td>-2</td><td>416.00</td> <td>-51Ded.</td><td>166.00</td> <td>-X</td><td>0.00</td> </tr> <tr> <td>-3</td><td>663.00</td> <td>-66</td><td>257.00</td> <td>-Y</td><td>0.00</td> </tr> <tr> <td>-3C</td><td>551.00</td> <td>-IRMA†</td><td>770.00</td> <td>-YGTC (2"-4")</td><td>41.00</td> </tr> <tr> <td>-12*</td><td>171.00</td> <td>-TSO ◊</td><td>309.00</td> <td>-Z</td><td>0.00</td> </tr> <tr> <td>-12-20*</td><td>268.00</td> <td>-T</td><td>129.00</td> <td></td><td></td> </tr> </tbody> </table> <p>* Specify Height, Price Per Inch † Price up to 4" Each additional inch, add \$127.00. ◊ Cannot be used with Drain Receiver</p>	LIST PRICE			PIPE SIZE	2", 3", 4"	\$3,452.00	-1	\$246.00	-20	\$475.00	-VP	240.00	-2	416.00	-51Ded.	166.00	-X	0.00	-3	663.00	-66	257.00	-Y	0.00	-3C	551.00	-IRMA†	770.00	-YGTC (2"-4")	41.00	-12*	171.00	-TSO ◊	309.00	-Z	0.00	-12-20*	268.00	-T	129.00			 <p>24060</p>	<p>15" SPECIAL-DUTY TOP COMPOSITION DECK FLANGE</p> <table border="1"> <thead> <tr> <th colspan="3">LIST PRICE</th> </tr> <tr> <th>PIPE SIZE</th> <th>4"- 6"</th> <th>8"</th> </tr> </thead> <tbody> <tr> <td></td> <td>\$5,224.00</td> <td>\$5,859.00</td> </tr> </tbody> </table> <p>ADD FOR OPTIONS:</p> <table border="1"> <tbody> <tr> <td>-1</td><td>\$401.00</td> <td>-29-20</td><td>\$849.00</td> <td>-51</td><td>\$1,294.00</td> </tr> <tr> <td>-20</td><td>1,817.00</td> <td>-31</td><td>436.00</td> <td>-66</td><td>257.00</td> </tr> <tr> <td>-29</td><td>512.00</td> <td>-50</td><td>1,496.00</td> <td>-VP</td><td>245.00</td> </tr> <tr> <td></td><td></td> <td></td><td></td> <td>-X</td><td>0.00</td> </tr> </tbody> </table> <p>* Specify Height, Price Per Inch</p>	LIST PRICE			PIPE SIZE	4"- 6"	8"		\$5,224.00	\$5,859.00	-1	\$401.00	-29-20	\$849.00	-51	\$1,294.00	-20	1,817.00	-31	436.00	-66	257.00	-29	512.00	-50	1,496.00	-VP	245.00					-X	0.00						
LIST PRICE																																																																																				
PIPE SIZE	2", 3", 4"	\$3,452.00																																																																																		
-1	\$246.00	-20	\$475.00	-VP	240.00																																																																															
-2	416.00	-51Ded.	166.00	-X	0.00																																																																															
-3	663.00	-66	257.00	-Y	0.00																																																																															
-3C	551.00	-IRMA†	770.00	-YGTC (2"-4")	41.00																																																																															
-12*	171.00	-TSO ◊	309.00	-Z	0.00																																																																															
-12-20*	268.00	-T	129.00																																																																																	
LIST PRICE																																																																																				
PIPE SIZE	4"- 6"	8"																																																																																		
	\$5,224.00	\$5,859.00																																																																																		
-1	\$401.00	-29-20	\$849.00	-51	\$1,294.00																																																																															
-20	1,817.00	-31	436.00	-66	257.00																																																																															
-29	512.00	-50	1,496.00	-VP	245.00																																																																															
				-X	0.00																																																																															
 <p>24020</p>	<p>9" SUPER-FLO® TOP, MEDIUM SUMP COMPOSITION DECK FLANGE</p> <table border="1"> <thead> <tr> <th colspan="3">LIST PRICE</th> </tr> <tr> <th>PIPE SIZE</th> <th>2", 3", 4"</th> <th>\$1,339.00</th> </tr> </thead> </table> <p>ADD FOR OPTIONS:</p> <table border="1"> <tbody> <tr> <td>-1</td><td>\$246.00</td> <td>-36</td><td>\$348.00</td> <td>-HP</td><td>\$176.00</td> </tr> <tr> <td>-20</td><td>1,129.00</td> <td>-38</td><td>Ded.148.00</td> <td>-VP</td><td>245.00</td> </tr> <tr> <td>-29</td><td>107.00</td> <td>-50</td><td>542.00</td> <td>-X</td><td>0.00</td> </tr> <tr> <td>-29-20</td><td>240.00</td> <td>-51</td><td>533.00</td> <td></td><td></td> </tr> <tr> <td>-31</td><td>\$188.00</td> <td>-66</td><td>257.00</td> <td></td><td></td> </tr> </tbody> </table>	LIST PRICE			PIPE SIZE	2", 3", 4"	\$1,339.00	-1	\$246.00	-36	\$348.00	-HP	\$176.00	-20	1,129.00	-38	Ded.148.00	-VP	245.00	-29	107.00	-50	542.00	-X	0.00	-29-20	240.00	-51	533.00			-31	\$188.00	-66	257.00			 <p>24200</p>	<p>16" PROMENADE TOP ALL LEVEL BONDING FLANGE</p> <table border="1"> <thead> <tr> <th colspan="3">LIST PRICE</th> </tr> <tr> <th>PIPE SIZE</th> <th>2"- 6"</th> <th>\$7,984.00</th> </tr> </thead> </table> <p>ADD FOR OPTIONS:</p> <table border="1"> <tbody> <tr> <td>-1</td><td>\$401.00</td> <td>-51</td><td>\$3,037.00</td> <td>-X</td><td>0.00</td> </tr> <tr> <td>-20</td><td>1,587.00</td> <td>-66</td><td>257.00</td> <td></td><td></td> </tr> <tr> <td>-50</td><td>3,363.00</td> <td>-VP</td><td>245.00</td> <td></td><td></td> </tr> </tbody> </table>	LIST PRICE			PIPE SIZE	2"- 6"	\$7,984.00	-1	\$401.00	-51	\$3,037.00	-X	0.00	-20	1,587.00	-66	257.00			-50	3,363.00	-VP	245.00																							
LIST PRICE																																																																																				
PIPE SIZE	2", 3", 4"	\$1,339.00																																																																																		
-1	\$246.00	-36	\$348.00	-HP	\$176.00																																																																															
-20	1,129.00	-38	Ded.148.00	-VP	245.00																																																																															
-29	107.00	-50	542.00	-X	0.00																																																																															
-29-20	240.00	-51	533.00																																																																																	
-31	\$188.00	-66	257.00																																																																																	
LIST PRICE																																																																																				
PIPE SIZE	2"- 6"	\$7,984.00																																																																																		
-1	\$401.00	-51	\$3,037.00	-X	0.00																																																																															
-20	1,587.00	-66	257.00																																																																																	
-50	3,363.00	-VP	245.00																																																																																	
 <p>24500</p>	<p>SILL TYPE 4" DOME, SHALLOW SUMP</p> <table border="1"> <thead> <tr> <th colspan="4">LIST PRICE</th> </tr> <tr> <th>PIPE SIZE</th> <th>24500</th> <th>24500-45</th> <th>24500-90</th> </tr> </thead> <tbody> <tr> <td>2", 3"</td> <td>\$694.00</td> <td>\$880.00</td> <td>\$880.00</td> </tr> <tr> <td>4"</td> <td>1,007.00</td> <td>1,194.00</td> <td>1,194.00</td> </tr> </tbody> </table> <p>ADD FOR OPTIONS:</p> <table border="1"> <tbody> <tr> <td>-20</td><td>\$268.00</td> <td>-35</td><td>\$0.00</td> <td>-90</td><td>\$188.00</td> </tr> <tr> <td>-24</td><td>146.00</td> <td>-45</td><td>188.00</td> <td>-T</td><td>0.00</td> </tr> <tr> <td>-27</td><td>131.00</td> <td>-50</td><td>341.00</td> <td>-VP</td><td>90.00</td> </tr> <tr> <td>-33</td><td>389.00</td> <td>-51</td><td>197.00</td> <td></td><td></td> </tr> </tbody> </table>	LIST PRICE				PIPE SIZE	24500	24500-45	24500-90	2", 3"	\$694.00	\$880.00	\$880.00	4"	1,007.00	1,194.00	1,194.00	-20	\$268.00	-35	\$0.00	-90	\$188.00	-24	146.00	-45	188.00	-T	0.00	-27	131.00	-50	341.00	-VP	90.00	-33	389.00	-51	197.00																																													
LIST PRICE																																																																																				
PIPE SIZE	24500	24500-45	24500-90																																																																																	
2", 3"	\$694.00	\$880.00	\$880.00																																																																																	
4"	1,007.00	1,194.00	1,194.00																																																																																	
-20	\$268.00	-35	\$0.00	-90	\$188.00																																																																															
-24	146.00	-45	188.00	-T	0.00																																																																															
-27	131.00	-50	341.00	-VP	90.00																																																																															
-33	389.00	-51	197.00																																																																																	

	24700 PARAPET TYPE, SLOPING GRATE				
	LIST PRICE				
	PIPE SIZE	2", 3", 4"	5", 6"		
	\$1,737.00	\$3,151.00			
ADD FOR OPTIONS:					
-20 (2" - 4") \$393.00 -51 \$539.00 -20 (5" - 6") 794.00 -61 (2" - 4") 561.00 -22 Deduct 705.00 -61 (5" - 6") 936.00 -24 737.00 -61-20 (2" - 4") 803.00 -45 0.00 -61-20 (5" - 6") 1,042.00 -50 969.00					
	24720 PARAPET TYPE, ANGLE GRATE				
	LIST PRICE				
	PIPE SIZE	24720	24720-45		
	\$1,096.00	\$1,096.00			
	5", 6"	2,082.00	2,082.00		
ADD FOR OPTIONS:					
-20 (2" - 4") \$396.00 -50 \$1,677.00 -20 (5" - 6") 794.00 -51 1,247.00 -23 (2" - 4") 707.00 -61 (2" - 4") 561.00 -23 (5" - 6") 1,156.00 -61 (5" - 6") 936.00 -24 (2" - 4") 1,477.00 -61-20 (2" - 4") 803.00 -24 (5" - 6") 2,415.00 -61-20 (5" - 6") 1,042.00 -45 0.00 -VP 102.00					
	24900 PARAPET TYPE, ANGLE DOME GRATE				
	LIST PRICE				
	PIPE SIZE	2" - 6"		\$6,220.00	
ADD FOR OPTIONS:					
-20 \$882.00 -61 (5" - 6") \$936.00 -24 969.00 -61-20 (2" - 4") 803.00 -50 1,263.00 -61-20 (5" - 6") 1,042.00 -51 894.00 -VP 102.00 -61 (2" - 4") 561.00					
	25000 PARAPET SCUPPER SLEEVE				
	LIST PRICE				
	Wall Thickness	9"	13"	17"	21"
	\$1,551.00	\$1,763.00	\$2,176.00	\$2,325.00	
ADD FOR OPTIONS:					
-20 \$393.00					
	25010 DOWNSPOUT NOZZLE				
	LIST PRICE				
	PIPE SIZE	2", 3", 4"	5", 6"	8"	10"
	\$1,038.00	\$2,464.00	\$3,752.00	\$4,869.00	\$6,112.00
ADD FOR OPTIONS:					
-24 (2" - 6") \$753.00 -51 (10") \$644.00 -24 (8") 663.00 -BS 908.00 -24 (10") 888.00 -PVC 0.00 -51 (2" - 6") 475.00 -T 0.00 -51 (8") 499.00 -Z** 0.00					
* 12" Size No-Hub Only ** Bronze Only					
	25020 SPECIAL PURPOSE DOWNSPOUT COVER				
	LIST PRICE				
	PIPE SIZE	2", 3", 4"	5", 6"	8"	
	\$4,877.00	\$5,195.00	\$5,405.00		
PIPE SIZE	10"	12"	15"		
	\$5,719.00	\$6,066.00	\$6,407.00		
ADD FOR OPTIONS:					
-316 \$1,101.00 -VP \$244.00 -SLT 0.00 -Z (4" - 15") 246.00					
	25030 DOWNSPOUT BOOT, GALVANIZED				
	LIST PRICE				
	4x3	25033	\$2,463.00		
5x4	25034	2,724.00			
5x3	25035	2,982.00			
	25500 FLOSEPTOR®, LARGE SUMP				
	LIST PRICE				
	PIPE SIZE	2", 3", 4"	5", 6"		
	\$1,551.00	\$2,079.00			
ADD FOR OPTIONS:					
-AE \$1,174.00 -2 452.00 -X 0.00 -AER 694.00 -3 851.00 -Y 0.00 -CR 694.00 -10* 1,096.00 -YGTC (2" - 4") 41.00 -FG 915.00 -20 1,471.00 -Z 0.00 -OR 1,174.00 -66 \$612.00 -1 \$402.00 T 129.00					
*Specify Height, Price Each 4" or Fraction					
Option Descriptions					
-AE LEVELEZE® Adjustable Extension -AER Adjustable Extension with Rods -BS Bird Screen -CR Clamping Drain Receiver -FG Flat Grate (Replaces Dome Strainer) -HP Heel-Proof Grate -IRMA Perforated Stainless Steel Extension -OR Adjustable Extension with O-Ring -SLT Slotted Cover (1/4") -VP Vandal-Proof Dome -1 Deck Clamp Assembly -2 Drain Receiver -3 Deck Clamp Assembly and Drain Receiver -3C Drain Receiver and Drain Receiver Clips -10 Fixed Extension Collar, Cast Iron -10-20 Fixed Extension Collar, Galvanized -12 Extended Flashing Collar, Cast Iron -12-20 Extended Flashing Collar, Galvanized -20 Galvanized Cast Iron Parts -22 Cast Iron Grate -23 Rough Bronze Grate -24 Rough Nikaloy Dome or Grate -27 High Dome -29 Sediment Bucket, Cast Iron -29-20 Sediment Bucket, Galvanized -31 Chain Anchored Grate -33 Stainless Mesh Screen-Covered Dome -35 Flat Grate -36 Ductile Iron Grate (Cast Iron Top Only) -38 Less Grate -50 C.I. Undergrate Laminated Top, Satin Finish Nikaloy -51 C.I. Undergrate Laminated Top, Satin Finish Bronze -61 Downspout Elbow, Cast Iron -61-20 Downspout Elbow, Galvanized -316 Type 316L Stainless Steel Outlets -45 Body with 45 Degree Threaded Outlet -66 No-Hub Side Outlet, 2" - 6" -90 Body with 90 Degree Threaded Outlet -PVC Metal Nozzle to fit PVC Pipe -T Threaded Outlet -TSO Threaded Side Outlet -X Inside Caulk Outlet -Y Hub Outlet with Gasket, 2" - 4" -YGTC -Y Outlet Gasket with Test Cap -Z No-Hub Spigot Outlet					

	FLO-SEPTOR®, MEDIUM SUMP		
	LIST PRICE		
	PIPE SIZE	2" - 6"	\$1,197.00
	ADD FOR OPTIONS:		
	-1.....\$246.00	-10*.....\$146.00	-T.....\$129.00
	-2.....426.00	-20.....323.00	-X.....0.00
	-3.....673.00	-66.....257.00	-Z.....0.00
	* Price per inch		

	FLO-SET®, 15" DOME, LARGE SUMP		
	LIST PRICE		
	PIPE SIZE	28600	28600-AE
	2", 3", 4" 5", 6"	\$3,111.00 \$3,616.00	\$4,286.00 \$4,791.00
ADD FOR OPTIONS:			
	-1.....\$402.00	10-20*.....\$1,737.00	-T.....\$129.00
	-2.....452.00	-20.....1,471.00	-VP.....205.00
	-3.....851.00	-23.....1,376.00	-X.....0.00
	-3C.....610.00	-66.....612.00	-Y.....0.00
	-4.....310.00	-AE.....1,174.00	-YGTC (2"-4") 41.00
	-10*.....1,096.00	-CR.....694.00	-Z.....0.00
	* Specify Height, Price Each 4" or Fraction		

	FLO-SEPTOR®, SMALL SUMP		
	LIST PRICE		
	PIPE SIZE	2", 3", 4"	\$973.00
	ADD FOR OPTIONS:		
	-1.....\$246.00	-66.....\$257.00	-Y.....\$0.00
	-2.....426.00	-T.....129.00	-YGTC (2"-4") 41.00
	-3.....673.00	-TSO*.....361.00	-Z.....0.00
	-20.....323.00	-X.....0.00	
	* Cannot be used with Drain Receiver		

	ISOLATION DECK DRAIN			
	LIST PRICE			
	PIPE SIZE	2", 3", 4"	5", 6"	8"
		\$1,174.00	\$1,666.00	\$2,176.00
ADD FOR OPTIONS:				
	-1.....\$402.00	-20.....\$1,359.00	-X.....\$0.00	
	-2.....453.00	-66.....612.00	-Y.....0.00	
	-3.....851.00	-CR.....694.00	-YGTC (2"-4") 41.00	
	-3C.....610.00	-T.....129.00	-Z.....0.00	
	-17.....380.00	-WH.....82.00		

	EXPANSION JOINT				
	LIST PRICE				
	PIPE SIZE	2"	3"	4"	5"
		\$1,096.00	\$1,174.00	\$1,325.00	\$1,919.00
PIPE SIZE	6"	8"	10"		
	\$2,205.00	\$3,893.00	\$8,099.00		
ADD FOR OPTIONS:					
	-BR (2" - 8").....\$478.00			-20.....\$296.00	

	16" DOME, EXTRA LARGE SUMP			
	LIST PRICE			
	PIPE SIZE	8"	10"	12"
		\$3,131.00	\$3,444.00	\$3,900.00
ADD FOR OPTIONS:				
	-1.....\$795.00	-10-20*.....2,578.00	-AER.....\$1,492.00	
	-2.....894.00	-17.....1,129.00	-VP.....205.00	
	-3.....1,687.00	-174.....1,783.00	-Z.....0.00	
	-10*.....1,635.00	-20.....2,364.00		
	* Specify Height, Price Each 4" or Fraction			









	STACK FLASHING FITTING			
	LIST PRICE			
	PIPE SIZE	1 1/2"	2"	3"
		\$312.00	\$312.00	\$361.00
PIPE SIZE	4"	5"	6"	
	\$465.00	\$673.00	\$673.00	
ADD FOR OPTIONS:				
	-20.....\$309.00			

	VENT STACK FLASHING SLEEVE			
	LIST PRICE			
	PIPE SIZE	1 1/2"	2"	3"
		\$102.00	\$102.00	\$181.00
PIPE SIZE	4"	5"	6"	
	\$205.00	\$268.00	\$516.00	
ADD FOR OPTIONS:				
	-20.....\$131.00			

	VANDAL-PROOF VENT CAP				
	LIST PRICE				
	PIPE SIZE	1 1/2"	2"	2 1/2"	3"
		\$694.00	\$694.00	\$775.00	\$775.00
PIPE SIZE	4"	5"	6"		
	\$869.00	\$1,017.00	\$1,116.00		
ADD FOR OPTIONS:					
	-20.....\$288.00	-63.....\$694.00			
	-33.....439.00	-65.....753.00			

Roof Drain Option Descriptions

- AE LEVELEZE® Adjustable Extension
- AER Adjustable Extension using Threaded Rod Hardware
- BR Bronze Sleeve, 2" - 8"
- CR Clamping Drain Receiver
- VP Vandal-Proof Dome
- WH Weeping Holes
- 1 Deck Clamp Assembly
- 2 Drain Receiver
- 3 Deck Clamp Assembly and Drain Receiver
- 3C Drain Receiver and Drain Receiver Clips
- 4 Secondary Flashing Clamp (use with -AE Only)
- 10 Fixed Extension Collar, Cast Iron
- 10-20 Fixed Extension Collar, Galvanized
- 17 2" High Solid Clamping Collar
- 174 4" High Solid Clamping Collar
- 20 Galvanized Cast Iron Parts
- 23 Rough Bronze Dome
- 33 Stainless Steel Mesh-Covered
- 63 All Rough Bronze
- 65 All Rough Nikaloy
- Outlets
- 66 No-Hub Side Outlet, 2" - 6"
- T Threaded Outlet
- TSO Threaded Side Outlet
- X Inside Caulk Outlet
- Y Hub Outlet with Gasket, 2" - 4"
- YGTC -Y Outlet Gasket with Test Cap
- Z No-Hub Spigot Outlet

 <p>A</p>	<p>ROUND NIKALOY SUPER-FLO® STRAINER</p> <table border="1"> <thead> <tr> <th colspan="5">LIST PRICE</th> </tr> <tr> <th>Strainer</th> <th>Strainer Only</th> <th>With 30000†</th> <th>With 30304</th> <th>With 30000-ST</th> </tr> </thead> <tbody> <tr><td>5A</td><td>\$478.00</td><td>\$790.00</td><td>\$624.00</td><td>1,537.00</td></tr> <tr><td>6A</td><td>662.00</td><td>973.00</td><td>807.00</td><td>1,722.00</td></tr> <tr><td>7A</td><td>809.00</td><td>1,120.00</td><td>954.00</td><td>1,869.00</td></tr> <tr><td>8A</td><td>1,096.00</td><td>1,408.00</td><td>1,242.00</td><td>2,157.00</td></tr> <tr><td>9A*</td><td>1,610.00</td><td>1,922.00</td><td>1,756.00</td><td>2,670.00</td></tr> <tr><td>10A*</td><td>1,610.00</td><td>1,922.00</td><td>1,756.00</td><td>2,670.00</td></tr> </tbody> </table> <p>ADD FOR OPTIONS:</p> <table> <tr><td>-2 (5A).....Deduct \$39.00</td><td>-J.....627.00</td></tr> <tr><td>-2 (6A).....Deduct 100.00</td><td>-SS (5A).....920.00</td></tr> <tr><td>-2 (7A).....Deduct 58.00</td><td>-SS (6A).....1,170.00</td></tr> <tr><td>-2 (8A).....Deduct 76.00</td><td>-SS (7A).....1,650.00</td></tr> <tr><td>-2 (9A,10A)*.....Deduct 102.00</td><td>-SS (8A).....1,490.00</td></tr> <tr><td>-80.....181.00</td><td>-SS-LR (6A).....2,198.00</td></tr> <tr><td>-5A-CP.....74.00</td><td>-SS-LR-MFP (6A).....4,549.00</td></tr> <tr><td>-6A-CP.....78.00</td><td>-TSI.....POA</td></tr> <tr><td>-DBC (5", 6").....103.00</td><td>-VP.....90.00</td></tr> <tr><td>-DBC (8").....\$188.00</td><td>-YGTC (2"-4").....41.00</td></tr> <tr><td>-HD (5", 6").....341.00</td><td>* Not SUPER-FLO® Design</td></tr> </table> <p>†For 6" pipe size add \$757.00 to 30000 price</p>	LIST PRICE					Strainer	Strainer Only	With 30000†	With 30304	With 30000-ST	5A	\$478.00	\$790.00	\$624.00	1,537.00	6A	662.00	973.00	807.00	1,722.00	7A	809.00	1,120.00	954.00	1,869.00	8A	1,096.00	1,408.00	1,242.00	2,157.00	9A*	1,610.00	1,922.00	1,756.00	2,670.00	10A*	1,610.00	1,922.00	1,756.00	2,670.00	-2 (5A).....Deduct \$39.00	-J.....627.00	-2 (6A).....Deduct 100.00	-SS (5A).....920.00	-2 (7A).....Deduct 58.00	-SS (6A).....1,170.00	-2 (8A).....Deduct 76.00	-SS (7A).....1,650.00	-2 (9A,10A)*.....Deduct 102.00	-SS (8A).....1,490.00	-80.....181.00	-SS-LR (6A).....2,198.00	-5A-CP.....74.00	-SS-LR-MFP (6A).....4,549.00	-6A-CP.....78.00	-TSI.....POA	-DBC (5", 6").....103.00	-VP.....90.00	-DBC (8").....\$188.00	-YGTC (2"-4").....41.00	-HD (5", 6").....341.00	* Not SUPER-FLO® Design	 <p>D</p>	<p>ROUND NIKALOY DOME STRAINER</p> <table border="1"> <thead> <tr> <th colspan="5">LIST PRICE</th> </tr> <tr> <th>Strainer</th> <th>Strainer Only</th> <th>With 30000†</th> <th>With 30304</th> <th>With 30000-ST</th> </tr> </thead> <tbody> <tr><td>5D</td><td>\$809.00</td><td>\$1,120.00</td><td>\$954.00</td><td>\$1,869.00</td></tr> <tr><td>6D</td><td>1,037.00</td><td>1,349.00</td><td>1,182.00</td><td>2,097.00</td></tr> </tbody> </table> <p>ADD FOR OPTIONS:</p> <table> <tr><td>-2 (5D).....Deduct \$61.00</td><td>-TSI.....POA</td></tr> <tr><td>-2 (6D).....Deduct 129.00</td><td>-VP.....90.00</td></tr> <tr><td>-80.....181.00</td><td>-YGTC (2"-4").....41.00</td></tr> <tr><td>-J.....\$627.00</td><td></td></tr> </table> <p>†For 6" pipe size add \$757.00 to 30000 price</p>	LIST PRICE					Strainer	Strainer Only	With 30000†	With 30304	With 30000-ST	5D	\$809.00	\$1,120.00	\$954.00	\$1,869.00	6D	1,037.00	1,349.00	1,182.00	2,097.00	-2 (5D).....Deduct \$61.00	-TSI.....POA	-2 (6D).....Deduct 129.00	-VP.....90.00	-80.....181.00	-YGTC (2"-4").....41.00	-J.....\$627.00	
LIST PRICE																																																																																													
Strainer	Strainer Only	With 30000†	With 30304	With 30000-ST																																																																																									
5A	\$478.00	\$790.00	\$624.00	1,537.00																																																																																									
6A	662.00	973.00	807.00	1,722.00																																																																																									
7A	809.00	1,120.00	954.00	1,869.00																																																																																									
8A	1,096.00	1,408.00	1,242.00	2,157.00																																																																																									
9A*	1,610.00	1,922.00	1,756.00	2,670.00																																																																																									
10A*	1,610.00	1,922.00	1,756.00	2,670.00																																																																																									
-2 (5A).....Deduct \$39.00	-J.....627.00																																																																																												
-2 (6A).....Deduct 100.00	-SS (5A).....920.00																																																																																												
-2 (7A).....Deduct 58.00	-SS (6A).....1,170.00																																																																																												
-2 (8A).....Deduct 76.00	-SS (7A).....1,650.00																																																																																												
-2 (9A,10A)*.....Deduct 102.00	-SS (8A).....1,490.00																																																																																												
-80.....181.00	-SS-LR (6A).....2,198.00																																																																																												
-5A-CP.....74.00	-SS-LR-MFP (6A).....4,549.00																																																																																												
-6A-CP.....78.00	-TSI.....POA																																																																																												
-DBC (5", 6").....103.00	-VP.....90.00																																																																																												
-DBC (8").....\$188.00	-YGTC (2"-4").....41.00																																																																																												
-HD (5", 6").....341.00	* Not SUPER-FLO® Design																																																																																												
LIST PRICE																																																																																													
Strainer	Strainer Only	With 30000†	With 30304	With 30000-ST																																																																																									
5D	\$809.00	\$1,120.00	\$954.00	\$1,869.00																																																																																									
6D	1,037.00	1,349.00	1,182.00	2,097.00																																																																																									
-2 (5D).....Deduct \$61.00	-TSI.....POA																																																																																												
-2 (6D).....Deduct 129.00	-VP.....90.00																																																																																												
-80.....181.00	-YGTC (2"-4").....41.00																																																																																												
-J.....\$627.00																																																																																													
 <p>6AD</p>	<p>ROUND NIKALOY STRAINER w/CLAMP DEVICE</p> <table border="1"> <thead> <tr> <th colspan="5">LIST PRICE</th> </tr> <tr> <th>Strainer</th> <th>Strainer Only</th> <th>With 30000†</th> <th>With 30304</th> <th>With 30000-ST</th> </tr> </thead> <tbody> <tr><td>6AD</td><td>\$2,306.00</td><td>\$2,618.00</td><td>\$2,451.00</td><td>\$3,365.00</td></tr> </tbody> </table> <p>ADD FOR OPTIONS:</p> <table> <tr><td>-2.....Deduct \$263.00</td><td>-TSI.....POA</td></tr> <tr><td>-80.....181.00</td><td>-VP.....90.00</td></tr> <tr><td>-J.....\$627.00</td><td>-YGTC (2"-4").....41.00</td></tr> </table> <p>†For 6" pipe size add \$757.00 to 30000 price</p>	LIST PRICE					Strainer	Strainer Only	With 30000†	With 30304	With 30000-ST	6AD	\$2,306.00	\$2,618.00	\$2,451.00	\$3,365.00	-2.....Deduct \$263.00	-TSI.....POA	-80.....181.00	-VP.....90.00	-J.....\$627.00	-YGTC (2"-4").....41.00	 <p>E</p>	<p>ROUND NIKALOY TRACTOR STRAINER</p> <table border="1"> <thead> <tr> <th colspan="5">LIST PRICE</th> </tr> <tr> <th>Strainer</th> <th>Strainer Only</th> <th>With 30000†</th> <th>With 30304</th> <th>With 30000-ST</th> </tr> </thead> <tbody> <tr><td>6E</td><td>1,214.00</td><td>1,526.00</td><td>1,360.00</td><td>\$2,274.00</td></tr> <tr><td>7E</td><td>1,533.00</td><td>1,845.00</td><td>1,678.00</td><td>2,594.00</td></tr> <tr><td>9E</td><td>2,248.00</td><td>2,560.00</td><td>2,393.00</td><td>3,306.00</td></tr> </tbody> </table> <p>ADD FOR OPTIONS:</p> <table> <tr><td>-2 (6E).....Deduct \$100.00</td><td>-SS (6E).....760.00</td></tr> <tr><td>-2 (7E).....Deduct 154.00</td><td>-SS (7E).....760.00</td></tr> <tr><td>-2 (9E).....Deduct 181.00</td><td>-TSI.....POA</td></tr> <tr><td>-80.....181.00</td><td>-VP.....90.00</td></tr> <tr><td>-93 (7E).....Deduct 947.00</td><td>-YGTC (2"-4").....41.00</td></tr> <tr><td>-J.....\$627.00</td><td></td></tr> </table> <p>†For 6" pipe size add \$757.00 to 30000 price</p>	LIST PRICE					Strainer	Strainer Only	With 30000†	With 30304	With 30000-ST	6E	1,214.00	1,526.00	1,360.00	\$2,274.00	7E	1,533.00	1,845.00	1,678.00	2,594.00	9E	2,248.00	2,560.00	2,393.00	3,306.00	-2 (6E).....Deduct \$100.00	-SS (6E).....760.00	-2 (7E).....Deduct 154.00	-SS (7E).....760.00	-2 (9E).....Deduct 181.00	-TSI.....POA	-80.....181.00	-VP.....90.00	-93 (7E).....Deduct 947.00	-YGTC (2"-4").....41.00	-J.....\$627.00																																	
LIST PRICE																																																																																													
Strainer	Strainer Only	With 30000†	With 30304	With 30000-ST																																																																																									
6AD	\$2,306.00	\$2,618.00	\$2,451.00	\$3,365.00																																																																																									
-2.....Deduct \$263.00	-TSI.....POA																																																																																												
-80.....181.00	-VP.....90.00																																																																																												
-J.....\$627.00	-YGTC (2"-4").....41.00																																																																																												
LIST PRICE																																																																																													
Strainer	Strainer Only	With 30000†	With 30304	With 30000-ST																																																																																									
6E	1,214.00	1,526.00	1,360.00	\$2,274.00																																																																																									
7E	1,533.00	1,845.00	1,678.00	2,594.00																																																																																									
9E	2,248.00	2,560.00	2,393.00	3,306.00																																																																																									
-2 (6E).....Deduct \$100.00	-SS (6E).....760.00																																																																																												
-2 (7E).....Deduct 154.00	-SS (7E).....760.00																																																																																												
-2 (9E).....Deduct 181.00	-TSI.....POA																																																																																												
-80.....181.00	-VP.....90.00																																																																																												
-93 (7E).....Deduct 947.00	-YGTC (2"-4").....41.00																																																																																												
-J.....\$627.00																																																																																													
 <p>AF</p>	<p>ROUND NIKALOY STRAINER w/TILE FLANGE</p> <table border="1"> <thead> <tr> <th colspan="5">LIST PRICE</th> </tr> <tr> <th>Strainer</th> <th>Strainer Only</th> <th>With 30000†</th> <th>With 30304</th> <th>With 30000-ST</th> </tr> </thead> <tbody> <tr><td>6AF</td><td>\$1,533.00</td><td>\$1,845.00</td><td>\$1,678.00</td><td>\$2,594.00</td></tr> </tbody> </table> <p>ADD FOR OPTIONS:</p> <table> <tr><td>-2.....Deduct \$154.00</td><td>-TSI.....POA</td></tr> <tr><td>-80.....181.00</td><td>-VP.....90.00</td></tr> <tr><td>-J.....627.00</td><td>-YGTC (2"-4").....41.00</td></tr> </table> <p>†For 6" pipe size add \$757.00 to 30000 price</p>	LIST PRICE					Strainer	Strainer Only	With 30000†	With 30304	With 30000-ST	6AF	\$1,533.00	\$1,845.00	\$1,678.00	\$2,594.00	-2.....Deduct \$154.00	-TSI.....POA	-80.....181.00	-VP.....90.00	-J.....627.00	-YGTC (2"-4").....41.00	 <p>E1</p>	<p>ROUND NIKALOY TRACTOR STRAINER w/EXTENDER RIM</p> <table border="1"> <thead> <tr> <th colspan="5">LIST PRICE</th> </tr> <tr> <th>Strainer</th> <th>Strainer Only</th> <th>With 30000†</th> <th>With 30304</th> <th>With 30000-ST</th> </tr> </thead> <tbody> <tr><td>6E1</td><td>1,294.00</td><td>\$1,605.00</td><td>\$1,440.00</td><td>\$2,354.00</td></tr> <tr><td>7E1</td><td>1,533.00</td><td>1,845.00</td><td>1,678.00</td><td>2,594.00</td></tr> <tr><td>9E1</td><td>2,272.00</td><td>2,584.00</td><td>2,417.00</td><td>3,331.00</td></tr> </tbody> </table> <p>ADD FOR OPTIONS:</p> <table> <tr><td>-2 (6E1).....Deduct \$176.00</td><td>-J.....\$627.00</td></tr> <tr><td>-2 (7E1).....Deduct 160.00</td><td>-TSI.....POA</td></tr> <tr><td>-2 (9E1).....Deduct 212.00</td><td>-VP.....90.00</td></tr> <tr><td>-80.....181.00</td><td>-YGTC (2"-4").....41.00</td></tr> </table> <p>†For 6" pipe size add \$757.00 to 30000 price</p>	LIST PRICE					Strainer	Strainer Only	With 30000†	With 30304	With 30000-ST	6E1	1,294.00	\$1,605.00	\$1,440.00	\$2,354.00	7E1	1,533.00	1,845.00	1,678.00	2,594.00	9E1	2,272.00	2,584.00	2,417.00	3,331.00	-2 (6E1).....Deduct \$176.00	-J.....\$627.00	-2 (7E1).....Deduct 160.00	-TSI.....POA	-2 (9E1).....Deduct 212.00	-VP.....90.00	-80.....181.00	-YGTC (2"-4").....41.00																																				
LIST PRICE																																																																																													
Strainer	Strainer Only	With 30000†	With 30304	With 30000-ST																																																																																									
6AF	\$1,533.00	\$1,845.00	\$1,678.00	\$2,594.00																																																																																									
-2.....Deduct \$154.00	-TSI.....POA																																																																																												
-80.....181.00	-VP.....90.00																																																																																												
-J.....627.00	-YGTC (2"-4").....41.00																																																																																												
LIST PRICE																																																																																													
Strainer	Strainer Only	With 30000†	With 30304	With 30000-ST																																																																																									
6E1	1,294.00	\$1,605.00	\$1,440.00	\$2,354.00																																																																																									
7E1	1,533.00	1,845.00	1,678.00	2,594.00																																																																																									
9E1	2,272.00	2,584.00	2,417.00	3,331.00																																																																																									
-2 (6E1).....Deduct \$176.00	-J.....\$627.00																																																																																												
-2 (7E1).....Deduct 160.00	-TSI.....POA																																																																																												
-2 (9E1).....Deduct 212.00	-VP.....90.00																																																																																												
-80.....181.00	-YGTC (2"-4").....41.00																																																																																												
 <p>5C</p>	<p>ROUND NIKALOY NON-CLOG STRAINER w/INTEGRAL BUCKET</p> <table border="1"> <thead> <tr> <th colspan="5">LIST PRICE</th> </tr> <tr> <th>Strainer</th> <th>Strainer Only</th> <th>With 30000†</th> <th>With 30304</th> <th>With 30000-ST</th> </tr> </thead> <tbody> <tr><td>5C</td><td>\$1,271.00</td><td>\$1,582.00</td><td>\$1,416.00</td><td>\$2,331.00</td></tr> </tbody> </table> <p>ADD FOR OPTIONS:</p> <table> <tr><td>-2.....Deduct \$74.00</td><td>-VP.....90.00</td></tr> <tr><td>-TSI.....POA</td><td>-YGTC (2"-4").....41.00</td></tr> </table> <p>†For 6" pipe size add \$757.00 to 30000 price</p>	LIST PRICE					Strainer	Strainer Only	With 30000†	With 30304	With 30000-ST	5C	\$1,271.00	\$1,582.00	\$1,416.00	\$2,331.00	-2.....Deduct \$74.00	-VP.....90.00	-TSI.....POA	-YGTC (2"-4").....41.00	 <p>E2</p>	<p>ROUND NIKALOY STRAINER w/ROUND FUNNEL</p> <table border="1"> <thead> <tr> <th colspan="5">LIST PRICE</th> </tr> <tr> <th>Strainer</th> <th>Strainer Only</th> <th>With 30000†</th> <th>With 30304</th> <th>With 30000-ST</th> </tr> </thead> <tbody> <tr><td>7E2</td><td>\$1,516.00</td><td>\$1,827.00</td><td>\$1,662.00</td><td>\$2,576.00</td></tr> </tbody> </table> <p>ADD FOR OPTIONS:</p> <table> <tr><td>-2.....Deduct \$154.00</td><td>-TSI.....POA</td></tr> <tr><td>-80.....181.00</td><td>-VP.....90.00</td></tr> <tr><td>-J.....627.00</td><td>-YGTC (2"-4").....41.00</td></tr> </table> <p>†For 6" pipe size add \$757.00 to 30000 price</p>	LIST PRICE					Strainer	Strainer Only	With 30000†	With 30304	With 30000-ST	7E2	\$1,516.00	\$1,827.00	\$1,662.00	\$2,576.00	-2.....Deduct \$154.00	-TSI.....POA	-80.....181.00	-VP.....90.00	-J.....627.00	-YGTC (2"-4").....41.00																																																		
LIST PRICE																																																																																													
Strainer	Strainer Only	With 30000†	With 30304	With 30000-ST																																																																																									
5C	\$1,271.00	\$1,582.00	\$1,416.00	\$2,331.00																																																																																									
-2.....Deduct \$74.00	-VP.....90.00																																																																																												
-TSI.....POA	-YGTC (2"-4").....41.00																																																																																												
LIST PRICE																																																																																													
Strainer	Strainer Only	With 30000†	With 30304	With 30000-ST																																																																																									
7E2	\$1,516.00	\$1,827.00	\$1,662.00	\$2,576.00																																																																																									
-2.....Deduct \$154.00	-TSI.....POA																																																																																												
-80.....181.00	-VP.....90.00																																																																																												
-J.....627.00	-YGTC (2"-4").....41.00																																																																																												

Strainer Option Descriptions

-CP	Chrome Plated	-TSI	Trap Seal Insert
-DBC	Debris Cover	-VP	Secured Grate, Vandal-Proof Screws
-HD	Heavy-Duty Heel Proof (Nikaloy Only)	-YGTC	-Y Outlet Gasket with Test Cap
-J	Backwater Valve	-2	Satin Finish Bronze
-SS	Stainless Steel	-63	Spanner Wrench
-SS-LR	SS Ligature Resistant	-80	Perforated Stainless Steel Basket
-SS-LR-MFP	SS Ligature Resistant, Mirror Polish Finish	-93	Cast Iron Strainer

	ROUND NIKALOY STRAINER w/OVAL FUNNEL				
	LIST PRICE				
	Strainer	Strainer Only	With 30000†	With 30304	With 30000-ST
	7E3	\$2,264.00	\$2,576.00	\$2,410.00	\$3,324.00
ADD FOR OPTIONS:					
-2Deduct \$154.00 -TSI POA					
-80 181.00 -VP 90.00					
-J 627.00 -YGTC (2"-4") 41.00					
†For 6" pipe size add \$757.00 to 30000 price					

	ROUND NIKALOY STRAINER w/SOLID HINGED COVER				
	LIST PRICE				
	Strainer	Strainer Only	With 30000†	With 30304	With 30000-ST
	5G 6G 7G 8G	\$1,121.00 1,275.00 1,986.00 2,017.00	\$1,433.00 1,586.00 2,297.00 2,329.00	1,267.00 1,421.00 2,132.00 2,162.00	\$2,182.00 2,334.00 3,046.00 3,077.00
ADD FOR OPTIONS:					
-2 (5G)Deduct \$90.00 -J \$627.00					
-2 (6G)Deduct 176.00 -TSI POA					
-2 (7G)Deduct 243.00 -VP 90.00					
-2 (8G)Deduct 181.00 -YGTC (2"-4") 41.00					
†For 6" pipe size add \$757.00 to 30000 price					

	ROUND NIKALOY STRAINER w/SOLID THREADED COVER				
	LIST PRICE				
	Strainer	Strainer Only	With 30000†	With 30304	With 30000-ST
	6F	\$1,556.00	\$1,868.00	\$1,701.00	\$2,617.00
ADD FOR OPTIONS:					
-2Deduct \$123.00 -J 627.00					
-63 228.00 -TSI POA					
-80 \$181.00 -YGTC (2"-4") 41.00					
†For 6" pipe size add \$757.00 to 30000 price					

	ROUND NIKALOY STRAINER w/HINGED GRATE				
	LIST PRICE				
	Strainer	Strainer Only	With 30000†	With 30304	With 30000-ST
	5H 6H 7H 8H	\$936.00 1,037.00 1,275.00 1,435.00	1,246.00 1,349.00 1,586.00 1,747.00	\$1,082.00 1,182.00 1,421.00 1,581.00	\$1,995.00 2,097.00 2,334.00 2,496.00
ADD FOR OPTIONS:					
-2 (5H)Deduct \$68.00 -J 627.00					
-2 (6H)Deduct 100.00 -TSI POA					
-2 (7H)Deduct 58.00 -VP 90.00					
-2 (8H)Deduct 129.00 -YGTC (2"-4") 41.00					
-80 (6H - 8H) \$181.00					
†For 6" pipe size add \$757.00 to 30000 price					







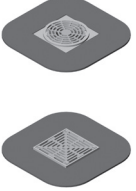

	ROUND NIKALOY FUNNEL ASSEMBLIES				
	LIST PRICE				
	Funnel				
	F4 F6	\$702.00 1,038.00			
ADD FOR OPTIONS:					
-2Deduct \$102.00 -93 (F4)Deduct \$411.00					
-92 (F4)Deduct 315.00 -93 (F6)Deduct 566.00					
-92 (F6)Deduct 476.00 -ARE 341.00					

	ROUND CHROME PLATED OVERFLOW STANDPIPE w/DOME				
	LIST PRICE				
	Strainer	Strainer Only	With 30000†	With 30304	With 30000-ST
	2M 3M	\$2,923.00 3,734.00	\$3,234.00 4,046.00	\$3,069.00 3,880.00	\$3,983.00 4,794.00
ADD FOR OPTIONS:					
-2 (2M)Deduct \$499.00 -24 (3M)Deduct 627.00					
-2 (3M)Deduct 310.00 -PF 572.00					
-24 (2M)Deduct 468.00 -YGTC (2"-4") 41.00					
†For 6" pipe size add \$757.00 to 30000 price					
For Each Inch Over 6" Standard					
		CP	-2		
Add for 2M		\$223.00	\$163.00		
Add for 3M		315.00	279.00		

	OVAL NIKALOY FUNNEL ASSEMBLIES				
	LIST PRICE				
	Funnel				
	F8 F9	\$702.00 1,455.00			
ADD FOR OPTIONS:					
-2Deduct \$102.00 -93 (F8)Deduct \$411.00					
-92 (F8)Deduct 315.00 -93 (F9)Deduct 750.00					
-92 (F9)Deduct 656.00 -ARE 341.00					

	ANGLE NIKALOY STRAINER				
	LIST PRICE				
	Strainer	Strainer Only	With 30000†	With 30304	With 30000-ST
	4P 6P	\$2,923.00 3,734.00	\$3,234.00 4,046.00	\$3,069.00 3,880.00	\$3,983.00 4,794.00
ADD FOR OPTIONS:					
-2 (4P)Deduct \$246.00 -TSI POA					
-2 (6P)Deduct 310.00 -VP 90.00					
-80 \$181.00 -YGTC (2"-4") 41.00					
†For 6" pipe size add \$757.00 to 30000 price					

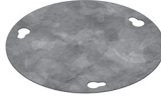
	ROUND CAST IRON FUNNEL ASSEMBLIES				
	LIST PRICE				
	Funnel				
	F52 F53	\$539.00 719.00			
ADD FOR OPTIONS:					
-1 \$890.00 -92 \$212.00					

<p>R</p> 	<p>RECTANGULAR NIKALOY STRAINER</p> <table border="1"> <thead> <tr> <th colspan="5">LIST PRICE</th> </tr> <tr> <th>Strainer</th> <th>Strainer Only</th> <th>With 30000†</th> <th>With 30304</th> <th>With 30000-ST</th> </tr> </thead> <tbody> <tr> <td>5R</td> <td>\$1,435.00</td> <td>\$1,747.00</td> <td>\$1,581.00</td> <td>\$2,496.00</td> </tr> <tr> <td>6R</td> <td>2,060.00</td> <td>2,372.00</td> <td>2,206.00</td> <td>3,121.00</td> </tr> <tr> <td>7R</td> <td>2,207.00</td> <td>2,519.00</td> <td>2,353.00</td> <td>3,268.00</td> </tr> <tr> <td>8R</td> <td>3,331.00</td> <td>3,642.00</td> <td>3,477.00</td> <td>4,391.00</td> </tr> </tbody> </table> <p>ADD FOR OPTIONS:</p> <p>-2 (5R).....Deduct \$129.00 -TSI.....POA -2 (6R, 7R).....Deduct 223.00 -VP.....90.00 -2 (8R).....Deduct 434.00 -YGTC (2"-4").....41.00 -80.....181.00 †For 6" pipe size add \$757.00 -J.....627.00 to 30000 price</p>	LIST PRICE					Strainer	Strainer Only	With 30000†	With 30304	With 30000-ST	5R	\$1,435.00	\$1,747.00	\$1,581.00	\$2,496.00	6R	2,060.00	2,372.00	2,206.00	3,121.00	7R	2,207.00	2,519.00	2,353.00	3,268.00	8R	3,331.00	3,642.00	3,477.00	4,391.00	<p>WF6A WF6S</p> 	<p>NIKALOY STRAINERS FOR COMPOSITION DECKS</p> <table border="1"> <thead> <tr> <th colspan="5">LIST PRICE</th> </tr> <tr> <th>Strainer</th> <th>Strainer Only</th> <th>With 30000†</th> <th>With 30304</th> <th>With 30000-ST</th> </tr> </thead> <tbody> <tr> <td>6A</td> <td>\$1,779.00</td> <td>\$2,091.00</td> <td>\$1,925.00</td> <td>\$2,839.00</td> </tr> <tr> <td>6S</td> <td>1,986.00</td> <td>2,297.00</td> <td>2,132.00</td> <td>3,046.00</td> </tr> </tbody> </table> <p>ADD FOR OPTIONS:</p> <p>-2 (6A).....Deduct \$100.00 -TSI.....POA -2 (6S).....Deduct 58.00 -VP.....90.00 -80.....181.00 -YGTC (2"-4").....41.00 -J.....\$627.00</p> <p>Can be used with all Floor Drain Bodies on this Page. †For 6" pipe size add \$757.00 to 30000 price</p>	LIST PRICE					Strainer	Strainer Only	With 30000†	With 30304	With 30000-ST	6A	\$1,779.00	\$2,091.00	\$1,925.00	\$2,839.00	6S	1,986.00	2,297.00	2,132.00	3,046.00
LIST PRICE																																																					
Strainer	Strainer Only	With 30000†	With 30304	With 30000-ST																																																	
5R	\$1,435.00	\$1,747.00	\$1,581.00	\$2,496.00																																																	
6R	2,060.00	2,372.00	2,206.00	3,121.00																																																	
7R	2,207.00	2,519.00	2,353.00	3,268.00																																																	
8R	3,331.00	3,642.00	3,477.00	4,391.00																																																	
LIST PRICE																																																					
Strainer	Strainer Only	With 30000†	With 30304	With 30000-ST																																																	
6A	\$1,779.00	\$2,091.00	\$1,925.00	\$2,839.00																																																	
6S	1,986.00	2,297.00	2,132.00	3,046.00																																																	
<p>S</p> 	<p>SQUARE NIKALOY SUPER-FLO® STRAINER</p> <table border="1"> <thead> <tr> <th colspan="5">LIST PRICE</th> </tr> <tr> <th>Strainer</th> <th>Strainer Only</th> <th>With 30000†</th> <th>With 30304</th> <th>With 30000-ST</th> </tr> </thead> <tbody> <tr> <td>5S</td> <td>\$750.00</td> <td>\$1,062.00</td> <td>\$896.00</td> <td>\$1,810.00</td> </tr> <tr> <td>6S</td> <td>869.00</td> <td>1,181.00</td> <td>1,015.00</td> <td>1,930.00</td> </tr> <tr> <td>8S</td> <td>1,402.00</td> <td>1,714.00</td> <td>1,548.00</td> <td>2,462.00</td> </tr> <tr> <td>9S</td> <td>1,870.00</td> <td>2,181.00</td> <td>2,016.00</td> <td>2,931.00</td> </tr> </tbody> </table> <p>ADD FOR OPTIONS:</p> <p>-2 (5S).....Deduct \$90.00 -HD (5", 6").....341.00 -2 (6S).....Deduct 58.00 -J.....627.00 -2 (8S).....Deduct 160.00 -SS (5S).....730.00 -2 (9S)*.....Deduct 181.00 -SS (6S).....1,020.00 -5S-CP.....90.00 -SS (8S).....1,270.00 -6S-CP.....107.00 -TSI.....POA -80.....181.00 -VP.....90.00 -DBC (5", 6").....\$103.00 -YGTC (2"-4").....41.00 -DBC (8").....188.00</p> <p>* Not SUPER-FLO® Design †For 6" pipe size add \$757.00 to 30000 price</p>	LIST PRICE					Strainer	Strainer Only	With 30000†	With 30304	With 30000-ST	5S	\$750.00	\$1,062.00	\$896.00	\$1,810.00	6S	869.00	1,181.00	1,015.00	1,930.00	8S	1,402.00	1,714.00	1,548.00	2,462.00	9S	1,870.00	2,181.00	2,016.00	2,931.00	<p>NBRG</p> 	<p>1/4" NIKALOY RIM AND GRATE EXTENSION</p> <table border="1"> <thead> <tr> <th colspan="4">LIST PRICE</th> </tr> <tr> <th>Type No.</th> <th>NBRG</th> <th>Type No. Rim Only</th> <th>NBR* (1/4" Rim Only)</th> </tr> </thead> <tbody> <tr> <td>5A-NBRG</td> <td>\$224.00</td> <td>5ANBR†</td> <td>\$71.00</td> </tr> <tr> <td>6A-NBRG</td> <td>255.00</td> <td>6ANBR</td> <td>97.00</td> </tr> </tbody> </table> <p>* Standard strainer grates will not fit NBR rims. † 5ANBR Can be used with Nikaloy Top 55000-1. (Can not be used with 4" X and 6" Z)</p>	LIST PRICE				Type No.	NBRG	Type No. Rim Only	NBR* (1/4" Rim Only)	5A-NBRG	\$224.00	5ANBR†	\$71.00	6A-NBRG	255.00	6ANBR	97.00				
LIST PRICE																																																					
Strainer	Strainer Only	With 30000†	With 30304	With 30000-ST																																																	
5S	\$750.00	\$1,062.00	\$896.00	\$1,810.00																																																	
6S	869.00	1,181.00	1,015.00	1,930.00																																																	
8S	1,402.00	1,714.00	1,548.00	2,462.00																																																	
9S	1,870.00	2,181.00	2,016.00	2,931.00																																																	
LIST PRICE																																																					
Type No.	NBRG	Type No. Rim Only	NBR* (1/4" Rim Only)																																																		
5A-NBRG	\$224.00	5ANBR†	\$71.00																																																		
6A-NBRG	255.00	6ANBR	97.00																																																		
<p>T</p> 	<p>SQUARE NIKALOY STRAINER w/HINGED GRATE</p> <table border="1"> <thead> <tr> <th colspan="5">LIST PRICE</th> </tr> <tr> <th>Strainer</th> <th>Strainer Only</th> <th>With 30000†</th> <th>With 30304</th> <th>With 30000-ST</th> </tr> </thead> <tbody> <tr> <td>5T</td> <td>\$1,096.00</td> <td>1,408.00</td> <td>1,242.00</td> <td>\$2,157.00</td> </tr> <tr> <td>6T</td> <td>1,325.00</td> <td>1,636.00</td> <td>1,470.00</td> <td>2,384.00</td> </tr> <tr> <td>9T</td> <td>2,407.00</td> <td>2,718.00</td> <td>2,553.00</td> <td>3,467.00</td> </tr> </tbody> </table> <p>ADD FOR OPTIONS:</p> <p>-2 (5T).....Deduct \$90.00 -SC (6T).....416.00 -2 (6T).....Deduct 68.00 -TSI.....POA -2 (9T).....Deduct 181.00 -VP.....90.00 -80 (6T, 9T).....181.00 -YGTC (2"-4").....41.00 -J.....\$627.00</p> <p>†For 6" pipe size add \$757.00 to 30000 price</p>	LIST PRICE					Strainer	Strainer Only	With 30000†	With 30304	With 30000-ST	5T	\$1,096.00	1,408.00	1,242.00	\$2,157.00	6T	1,325.00	1,636.00	1,470.00	2,384.00	9T	2,407.00	2,718.00	2,553.00	3,467.00	<p>30000</p> 	<p>BODIES ONLY</p> <p>30000 BODY ASSEMBLY</p> <table border="1"> <thead> <tr> <th colspan="5">LIST PRICE</th> </tr> <tr> <th>PIPE SIZE</th> <th>30000</th> <th>30000-TSO</th> <th>30002-ST 30003-ST</th> <th>30000-PD</th> </tr> </thead> <tbody> <tr> <td>2" - 4"</td> <td>\$312.00</td> <td>\$673.00</td> <td>\$1,061.00</td> <td>1,174.00</td> </tr> <tr> <td>6" (Z)</td> <td>1,069.00</td> <td>—</td> <td>—</td> <td>—</td> </tr> </tbody> </table> <p>ADD FOR OPTIONS:</p> <p>-49.....\$0.00 -ST.....747.00 -50.....STD -T.....129.00 -91.....1,997.00 -TSI†.....POA -92.....323.00 -TSO.....361.00 -ARE.....288.00 -X.....0.00 -CC4.....919.00 -Y.....0.00 -MD.....181.00 -YGTC (2"-4").....41.00 -PFB.....243.00 -Z (2" - 4").....0.00 -PD.....\$862.00</p> <p>†Available up to 4" only</p>	LIST PRICE					PIPE SIZE	30000	30000-TSO	30002-ST 30003-ST	30000-PD	2" - 4"	\$312.00	\$673.00	\$1,061.00	1,174.00	6" (Z)	1,069.00	—	—	—					
LIST PRICE																																																					
Strainer	Strainer Only	With 30000†	With 30304	With 30000-ST																																																	
5T	\$1,096.00	1,408.00	1,242.00	\$2,157.00																																																	
6T	1,325.00	1,636.00	1,470.00	2,384.00																																																	
9T	2,407.00	2,718.00	2,553.00	3,467.00																																																	
LIST PRICE																																																					
PIPE SIZE	30000	30000-TSO	30002-ST 30003-ST	30000-PD																																																	
2" - 4"	\$312.00	\$673.00	\$1,061.00	1,174.00																																																	
6" (Z)	1,069.00	—	—	—																																																	
<p>W</p> 	<p>CAST IRON STRAINER EXTENSION</p> <table border="1"> <thead> <tr> <th colspan="5">LIST PRICE</th> </tr> <tr> <th>Strainer</th> <th>Strainer Only</th> <th>With 30000†</th> <th>With 30304</th> <th>With 30000-ST</th> </tr> </thead> <tbody> <tr> <td>2W</td> <td>\$228.00</td> <td>\$540.00</td> <td>\$373.00</td> <td>1,288.00</td> </tr> <tr> <td>4W</td> <td>411.00</td> <td>722.00</td> <td>555.00</td> <td>1,470.00</td> </tr> <tr> <td>6W</td> <td>612.00</td> <td>924.00</td> <td>758.00</td> <td>1,673.00</td> </tr> </tbody> </table> <p>ADD FOR OPTIONS:</p> <p>-TSI.....POA -YGTC (2"-4").....41.00</p> <p>Can be used with all Floor Drain Bodies on this page & previous. †For 6" pipe size add \$757.00 to 30000 price</p>	LIST PRICE					Strainer	Strainer Only	With 30000†	With 30304	With 30000-ST	2W	\$228.00	\$540.00	\$373.00	1,288.00	4W	411.00	722.00	555.00	1,470.00	6W	612.00	924.00	758.00	1,673.00	<p>30000-PD</p> 	<p>SECURITY BODY ASSEMBLY FOR PRISONS</p> <table border="1"> <thead> <tr> <th colspan="2">LIST PRICE</th> </tr> <tr> <th>PIPE SIZE</th> <th>30000-PD</th> </tr> </thead> <tbody> <tr> <td>2" - 3"</td> <td>\$1,174.00</td> </tr> </tbody> </table> <p>ADD FOR OPTIONS:</p> <p>-50.....\$0.00 -C.....\$0.00 -92.....323.00 -T.....0.00</p>	LIST PRICE		PIPE SIZE	30000-PD	2" - 3"	\$1,174.00																			
LIST PRICE																																																					
Strainer	Strainer Only	With 30000†	With 30304	With 30000-ST																																																	
2W	\$228.00	\$540.00	\$373.00	1,288.00																																																	
4W	411.00	722.00	555.00	1,470.00																																																	
6W	612.00	924.00	758.00	1,673.00																																																	
LIST PRICE																																																					
PIPE SIZE	30000-PD																																																				
2" - 3"	\$1,174.00																																																				
<p>DBC</p>  <p>Square not depicted.</p>	<p>DEBRIS COVER</p> <table border="1"> <thead> <tr> <th colspan="2">LIST PRICE</th> </tr> <tr> <th>Type No.</th> <th>Price</th> </tr> </thead> <tbody> <tr> <td>5A-DBC, 6A-DBC</td> <td>\$103.00</td> </tr> <tr> <td>5S-DBC, 6S-DBC</td> <td>103.00</td> </tr> <tr> <td>8A-DBC, 8S-DBC</td> <td>188.00</td> </tr> </tbody> </table>	LIST PRICE		Type No.	Price	5A-DBC, 6A-DBC	\$103.00	5S-DBC, 6S-DBC	103.00	8A-DBC, 8S-DBC	188.00	<p>30000-TSO</p> 	<p>BODY ASSEMBLY w/THREADED SIDE OUTLET</p> <table border="1"> <thead> <tr> <th colspan="2">LIST PRICE</th> </tr> <tr> <th>PIPE SIZE</th> <th>30000-TSO</th> </tr> </thead> <tbody> <tr> <td>2" - 4"</td> <td>\$673.00</td> </tr> </tbody> </table> <p>ADD FOR OPTIONS:</p> <p>-49.....\$0.00 -ARE.....\$288.00 -50.....0.00 -92.....323.00</p>	LIST PRICE		PIPE SIZE	30000-TSO	2" - 4"	\$673.00																																		
LIST PRICE																																																					
Type No.	Price																																																				
5A-DBC, 6A-DBC	\$103.00																																																				
5S-DBC, 6S-DBC	103.00																																																				
8A-DBC, 8S-DBC	188.00																																																				
LIST PRICE																																																					
PIPE SIZE	30000-TSO																																																				
2" - 4"	\$673.00																																																				

	BODY ASSEMBLY w/SHALLOW THREADED OUTLET TRAP	
	LIST PRICE	
	PIPE SIZE	30000-ST
	2" - 3"	\$1,061.00
ADD FOR OPTIONS:		
-49.....	\$0.00	-ARE..... \$288.00
-50.....	STD	-TSI..... POA
-92.....	323.00	-Z..... 0.00

	NO-HUB CAST IRON BODY	
	LIST PRICE	
	PIPE SIZE	30304
	4"	\$146.00

	BODY ASSEMBLY w/TRAP & FLUSH w/FLOOR CLEANOUT	
	LIST PRICE	
	PIPE SIZE	30500
	2" - 4"	\$1,870.00
ADD FOR OPTIONS:		
-49.....	\$246.00	-60..... \$630.00
-50.....	246.00	-92..... 869.00
-51.....	572.00	-C..... 0.00
-52.....	572.00	-Z..... 0.00

	BODY w/2" SHALLOW TRAP & ROUND CHROME PLATED STRAINER	
	LIST PRICE	
	PIPE SIZE	30802-4CP
	2"	\$901.00
ADD FOR OPTIONS:		
-LT.....	Deduct \$361.00	-T..... \$0.00
-SQ.....	107.00	-Z..... 0.00

EXPLANATION OF FLOOR DRAIN WEIGHT LOADS

Apart from their primary purpose of receiving and conveying liquids, floor drains, as integral components of the floor, must be structurally suitable to withstand the anticipated loads that will be imposed on the floor. Weight support requirements of the drain vary with the location, construction, and service condition. The top loading classifications as published in Floor Drain Standard ANSI/ASME A112.6.3 are as follows:

Light-Duty
Safe Live Load under 2000 lb. (900 kg.)

Medium-Duty
Safe Live Load between 2000 lb. (900 kg.) and 4999 lb. (2250 kg.)

Heavy-Duty
Safe Live Load between 5000 lb. (2250 kg.) and 7499 lb. (3375 kg.)

Extra Heavy-Duty
Safe Live Load between 7500 lb. (3375 kg.) and 10,000 lb. (4500 kg.)

Special-Duty
Safe Live Load over 10,000 lb. (4500 kg.) should be considered special and treated accordingly.

When the top loading requirements for a drain have been determined, the duty type needed can be resolved. Selection is easily accomplished as all JOSAM Floor Drains are classified according to duty type in this section. For specific detail loading data, contact JOSAM Engineering.

ADJUSTABLE FLOOR DRAIN ASSEMBLIES

	BODY w/9" ROUND NIKALOY STRAINER	
	LIST PRICE	
	PIPE SIZE	30900-9AD
	2" - 4"	\$3,351.00
ADD FOR OPTIONS:		
-2.....	Deduct \$342.00	-VP..... 90.00
-66 (2", 3").....	361.00	-X..... 0.00
-66 (4").....	512.00	-Y..... 0.00
-92.....	323.00	-YGTC (2"-4")..... 41.00
-T.....	129.00	-Z..... 0.00
-TSI.....	POA	

	BODY w/5" ROUND NIKALOY TOP	
	LIST PRICE	
	PIPE SIZE	31000
	2" - 4"	\$630.00
ADD FOR OPTIONS:		
-C.....	\$55.00	-Y (2", 3")..... \$0.00
-SQ.....	269.00	-Z (3", 4")..... 0.00
-TSI.....	POA	-YGTC (2"-4")..... 41.00

	BODY w/INTEGRAL TRAP AND AUXILIARY INETS	
	LIST PRICE	
	PIPE SIZE	31300
	2" - 4"	\$1,399.00
ADD FOR OPTIONS:		
-92.....	\$323.00	-ARE..... \$288.00

Option Descriptions

Strainers





- ARE Acid-Resisting Epoxy
- CP Chrome Plated
- DBC Debris Cover
- HD Heavy-Duty Heel Proof (Nikaloy Only)
- J Backwater Valve
- LT Less Shallow Trap
- PF Perforated Standpipe
- SC Solid Cover
- SS Stainless Steel
- SQ Square Top
- TSI Trap Seal Insert
- VP Secured Grate, Vandal-Proof Screws
- 2 Satin Finish Bronze
- 24 Less Dome
- 80 Perforated Stainless Steel Basket
- 92 Galvanized Cast Iron
- 93 Cast Iron

Bodies Only

- ARE Acid-Resisting Epoxy
- C Bolted Flashing Clamp Device
- CC4 Clamp Collar with 4" Thread
- MD PVC Clamp Collar with 3" Socket Connection
- PD Prison Drain
- PFB Pre-Fabricated Base
- ST Shallow Trap
- 49 3/4" Primer Tap
- 50 1/2" Primer Tap
- 51 1-1/2" Threaded Auxiliary Inlet
- 52 2" Threaded Auxiliary Inlet
- 60 Backwater Valve
- 91 Rough Bronze Body
- 92 Galvanized Cast Iron Parts

Outlets

- T Threaded Outlet
- TSO Threaded Side Outlet
- X Inside Caulk Outlet
- Y Hub Outlet with Gasket
- YGTC -Y Outlet Gasket with Test Cap
- Z No-Hub Outlet

FLOOR DRAINS		32100		32160		32200		32300		32330		
	SUPER-FLO® 9" TOP			DEEP BODY, 9" TRACTOR TOP			SHALLOW SUMP, SUPER-FLO® 12" TOP			MEDIUM SUMP, SUPER-FLO® 12" TOP		
	LIST PRICE			LIST PRICE			LIST PRICE			LIST PRICE		
	PIPE SIZE	32100		PIPE SIZE	32160		PIPE SIZE	32200		PIPE SIZE	32300	
	2" - 4" 6" (Z)	\$834.00 1,069.00		3", 4"	\$2,262.00		2" - 6" 8"	\$1,741.00 2,205.00		2" - 8"	\$2,106.00	
ADD FOR OPTIONS:			ADD FOR OPTIONS:			ADD FOR OPTIONS:			ADD FOR OPTIONS:			
-1.....\$831.00	-49.....\$269.00	-LC1.....\$2,184.00	-7.....\$312.00	-51.....\$572.00	-66.....\$612.00	-1.....\$1,244.00	-50.....\$246.00	-PFB.....\$272.00	-1.....\$1,244.00	-49.....\$246.00	-HP.....\$176.00	
-2.....707.00	-50.....269.00	-LC2.....1,997.00	-12.....533.00	-52.....572.00	-71†.....312.00	-2.....1,076.00	-66◇.....612.00	-SD.....154.00	-2.....1,076.00	-50.....246.00	-SD.....257.00	
-7.....389.00	-66.....713.00	-PFB.....243.00	-15.....402.00	-53.....770.00	-81†.....312.00	-7.....428.00	-81.....760.00	-SD-1.....1,399.00	-7.....428.00	-66**.....612.00	-SD-19.....2,460.00	
-11.....106.00	-81.....154.00	-T.....129.00	-19.....831.00	-54.....770.00	-88†.....90.00	-13.....228.00	-84.....694.00	-SD-2.....1,233.00	-13.....228.00	-88.....106.00	-SD-20**.....2,384.00	
-13.....134.00	-84.....478.00	-TG†.....201.00	-20.....694.00	-53-92.....874.00	-92.....930.00	-13-1.....2,056.00	-88.....106.00	-T.....129.00	-13-1.....2,056.00	-92.....1,067.00	-TSI†.....POA	
-13-1.....1,441.00	-88.....69.00	-TSI†.....POA	-44*.....465.00	-54-92.....874.00	-ARE.....1,544.00	-13-2.....1,763.00	-88.....106.00	-TSI†.....POA	-13-2.....1,763.00	-92.....1,067.00	-VP.....245.00	
-13-2.....1,151.00	-92.....705.00	-VP.....245.00	-49.....246.00	-60.....1,015.00	-HP.....176.00	-15.....393.00	-AE.....1,174.00	-VP.....245.00	-15.....393.00	-AE.....1,174.00	-X.....0.00	
-15.....402.00	-AE†.....336.00	-X.....0.00	-50.....246.00	-62(3")†.....644.00	-TSl.....POA	-44**.....411.00	-ARE.....1,392.00	-X.....0.00	-44**.....411.00	-HP.....176.00	-Y.....0.00	
-39.....804.00	-ARE.....852.00	-Y.....0.00	-50.....246.00	-62(4")†.....1,089.00	-VP.....312.00	-44-92**.....830.00	-HP-7.....269.00	-YGTC(2"-4") 41.00	-44-92**.....830.00	-HP-7.....269.00	-YGTC(2"-4") 41.00	
-44*.....465.00	-HP.....176.00	-YGTC(2"-4") 41.00				-49.....269.00	-HP-7.....269.00	-Z.....0.00	-49.....269.00	-HP-7.....269.00	-Z.....0.00	
-44-92*.....947.00	-HP-7.....269.00	-Z(2"-4").....0.00				-50.....269.00	-OR.....1,174.00	-Z.....0.00	-50.....269.00	-OR.....1,174.00	-Z.....0.00	
* Specify Height, Each 3" or Fraction			* Specify Height, Each 3" or Fraction			* Specify Height, Each 3" or Fraction			* Specify Height, Each 3" or Fraction			
† Available up to 4" only			† Available up to 4" only			† Available up to 4" only			† Available up to 4" only			
	9" TRACTOR TOP			32200			32300			32330		
	LIST PRICE			LIST PRICE			LIST PRICE			LIST PRICE		
	PIPE SIZE	32100-TG		32200			32300			32330		
	2" - 4"	\$1,036.00		32200			32300			32330		
ADD FOR OPTIONS:			ADD FOR OPTIONS:			ADD FOR OPTIONS:			ADD FOR OPTIONS:			
-1.....\$831.00	-66.....\$713.00	-T.....\$129.00	-1.....\$1,244.00	-50.....\$246.00	-PFB.....\$272.00	-1.....\$1,244.00	-49.....\$246.00	-HP.....\$176.00	-1.....\$1,244.00	-49.....\$246.00	-HP.....\$176.00	
-2.....707.00	-81.....154.00	-TSI†.....POA	-2.....1,076.00	-66◇.....612.00	-SD.....154.00	-2.....1,076.00	-66**.....612.00	-SD.....257.00	-2.....1,076.00	-66**.....612.00	-SD.....257.00	
-7.....389.00	-84.....478.00	-VP.....245.00	-7.....428.00	-81.....760.00	-SD-1.....1,399.00	-7.....428.00	-81.....760.00	-SD-19.....2,460.00	-7.....428.00	-81.....760.00	-SD-19.....2,460.00	
-15.....402.00	-88.....69.00	-X.....0.00	-13.....228.00	-84.....694.00	-SD-2.....1,233.00	-13.....228.00	-84.....694.00	-SD-20**.....2,384.00	-13.....228.00	-84.....694.00	-SD-20**.....2,384.00	
-44*.....465.00	-92.....705.00	-Y.....0.00	-13-1.....2,056.00	-88.....106.00	-T.....129.00	-13-1.....2,056.00	-88.....106.00	-TSI†.....POA	-13-1.....2,056.00	-88.....106.00	-TSI†.....POA	
-44-92*.....947.00	-92.....705.00	-Y.....0.00	-13-2.....1,763.00	-92.....1,067.00	-TSI†.....POA	-13-2.....1,763.00	-92.....1,067.00	-VP.....245.00	-13-2.....1,763.00	-92.....1,067.00	-VP.....245.00	
-49.....269.00	-AE.....336.00	-YGTC(2"-4") 41.00	-15.....393.00	-AE.....1,174.00	-VP.....245.00	-15.....393.00	-AE.....1,174.00	-X.....0.00	-15.....393.00	-AE.....1,174.00	-X.....0.00	
-50.....269.00	-ARE.....852.00	-Z(2"-4").....0.00	-44**.....411.00	-ARE.....1,392.00	-X.....0.00	-44**.....411.00	-ARE.....1,392.00	-Y.....0.00	-44**.....411.00	-ARE.....1,392.00	-Y.....0.00	
	-HP.....176.00		-44-92**.....830.00	-HP-7.....269.00	-YGTC(2"-4") 41.00	-44-92**.....830.00	-HP-7.....269.00	-YGTC(2"-4") 41.00	-44-92**.....830.00	-HP-7.....269.00	-YGTC(2"-4") 41.00	
	-HP-7.....269.00		-49.....246.00	-OR.....1,174.00	-Z.....0.00	-49.....246.00	-OR.....1,174.00	-Z.....0.00	-49.....246.00	-OR.....1,174.00	-Z.....0.00	
* Specify Height, Each 3" or Fraction			* Specify Height, Each 3" or Fraction			* Specify Height, Each 3" or Fraction			* Specify Height, Each 3" or Fraction			
† Available up to 4" only			† Available up to 4" only			† Available up to 4" only			† Available up to 4" only			
	SUPER-FLO® 9" BLOOD DRAIN			32300			32330			32330		
	LIST PRICE			LIST PRICE			LIST PRICE			LIST PRICE		
	PIPE SIZE	32150		32300			32330			32330		
	2" - 4"	\$2,497.00		32300			32330			32330		
ADD FOR OPTIONS:			ADD FOR OPTIONS:			ADD FOR OPTIONS:			ADD FOR OPTIONS:			
-1.....\$4,582.00	-T.....129.00		-1.....\$1,244.00	-49.....\$246.00	-HP.....\$176.00	-1.....\$1,244.00	-49.....\$246.00	-HP.....\$176.00	-1.....\$1,244.00	-49.....\$246.00	-HP.....\$176.00	
-2.....3,704.00	-TSI.....POA		-2.....1,076.00	-50.....246.00	-SD.....257.00	-2.....1,076.00	-50.....246.00	-SD.....257.00	-2.....1,076.00	-50.....246.00	-SD.....257.00	
-7.....901.00	-X.....0.00		-7.....428.00	-66**.....612.00	-SD-19.....2,460.00	-7.....428.00	-66**.....612.00	-SD-19.....2,460.00	-7.....428.00	-66**.....612.00	-SD-19.....2,460.00	
-44*.....609.00	-Y.....0.00		-13.....228.00	-81.....416.00	-SD-20**.....2,384.00	-13.....228.00	-81.....416.00	-SD-20**.....2,384.00	-13.....228.00	-81.....416.00	-SD-20**.....2,384.00	
-44-92*.....1,386.00	-Y.....0.00		-13-1.....2,056.00	-84.....694.00	-TSI†.....POA	-13-1.....2,056.00	-84.....694.00	-TSI†.....POA	-13-1.....2,056.00	-84.....694.00	-TSI†.....POA	
-92.....1,401.00	-YGTC(2"-4").....41.00		-13-2.....1,763.00	-88.....106.00	-VP.....245.00	-13-2.....1,763.00	-88.....106.00	-VP.....245.00	-13-2.....1,763.00	-88.....106.00	-VP.....245.00	
-ARE.....\$1,710.00	-Z.....0.00		-15.....393.00	-92.....1,067.00	-X.....0.00	-15.....393.00	-92.....1,067.00	-X.....0.00	-15.....393.00	-92.....1,067.00	-X.....0.00	
			-44*.....411.00	-AE.....1,174.00	-Z.....0.00	-44*.....411.00	-AE.....1,174.00	-Z.....0.00	-44*.....411.00	-AE.....1,174.00	-Z.....0.00	
			-44-92*.....830.00	-ARE.....1,587.00		-44-92*.....830.00	-ARE.....1,587.00		-44-92*.....830.00	-ARE.....1,587.00		
* Specify Height, Each 3" or Fraction			* Specify Height, Each 3" or Fraction			* Specify Height, Each 3" or Fraction			* Specify Height, Each 3" or Fraction			
† Available up to 4" only			† Available up to 4" only			† Available up to 4" only			† Available up to 4" only			
	DEEP SUMP, SUPER-FLO® 12" TOP w/BUCKET			32330			32330			32330		
	LIST PRICE			LIST PRICE			LIST PRICE			LIST PRICE		
	PIPE SIZE	32150		32300			32330			32330		
	2" - 4"	\$2,497.00		32300			32330			32330		
ADD FOR OPTIONS:			ADD FOR OPTIONS:			ADD FOR OPTIONS:			ADD FOR OPTIONS:			
-15.....\$393.00	-88.....\$154.00		-1.....\$1,244.00	-49.....\$246.00	-HP.....\$176.00	-15.....\$393.00	-88.....\$154.00		-1.....\$1,244.00	-49.....\$246.00	-HP.....\$176.00	
-19.....1,197.00	-92.....1,988.00		-2.....1,076.00	-50.....246.00	-SD.....257.00	-19.....1,197.00	-92.....1,988.00		-2.....1,076.00	-50.....246.00	-SD.....257.00	
-20.....1,037.00	-SD.....0.00		-7.....428.00	-66**.....612.00	-SD-19.....2,460.00	-20.....1,037.00	-SD.....0.00		-7.....428.00	-66**.....612.00	-SD-19.....2,460.00	
-49.....269.00	-TSI†.....POA		-13.....228.00	-81.....416.00	-SD-20**.....2,384.00	-49.....269.00	-TSI†.....POA		-13.....228.00	-81.....416.00	-SD-20**.....2,384.00	
-50.....269.00	-VP.....245.00		-13-1.....2,056.00	-84.....694.00	-TSI†.....POA	-50.....269.00	-VP.....245.00		-13-1.....2,056.00	-84.....694.00	-TSI†.....POA	
-66**.....612.00	-X.....0.00		-13-2.....1,763.00	-88.....106.00	-VP.....245.00	-66**.....612.00	-X.....0.00		-13-2.....1,763.00	-88.....106.00	-VP.....245.00	
-70.....Deduct 501.00	-Z.....0.00		-15.....393.00	-92.....1,067.00	-X.....0.00	-70.....Deduct 501.00	-Z.....0.00		-15.....393.00	-92.....1,067.00	-X.....0.00	
-84.....673.00			-44*.....411.00	-AE.....1,174.00	-Z.....0.00	-84.....673.00			-44*.....411.00	-AE.....1,174.00	-Z.....0.00	
			-44-92*.....830.00	-ARE.....1,587.00					-44-92*.....830.00	-ARE.....1,587.00		
* Specify Height, Each 3" or Fraction			* Specify Height, Each 3" or Fraction			* Specify Height, Each 3" or Fraction			* Specify Height, Each 3" or Fraction			
† Available up to 4" only			† Available up to 4" only			† Available up to 4" only			† Available up to 4" only			

	15" EXTRA HEAVY-DUTY TOP	
	LIST PRICE	
PIPE SIZE	34710	
2", 3", 4"	\$2,586.00	
5", 6"	3,065.00	
8"	3,659.00	
ADD FOR OPTIONS:		
-7.....\$1,015.00	-88.....\$154.00	-VP.....\$240.00
-15.....393.00	-92.....1,471.00	-X.....0.00
-19.....3,033.00	-AE.....1,174.00	-Y.....0.00
-20.....2,649.00	-ARE.....1,533.00	-YGTC (2"-4")41.00
-49.....246.00	-T.....129.00	-Z.....0.00
-50.....246.00	-TSI†.....POA	
†Available up to 4" only		

	15" EXTRA HEAVY-DUTY TOP w/BUCKET	
	LIST PRICE	
PIPE SIZE	34720	
3" - 6"	\$4,850.00	
ADD FOR OPTIONS:		
-7.....\$1,089.00	-50.....\$246.00	-TSI†.....POA
-15.....393.00	-66.....612.00	-VP.....342.00
-19.....3,033.00	-84.....694.00	-X.....0.00
-20.....2,649.00	-88.....154.00	-Z.....0.00
-49.....246.00	-92.....3,257.00	
†Available up to 4" only		

	NON-CLOG 21" ROUND TOP w/BUCKET	
	LIST PRICE	
PIPE SIZE	34920	
3" - 8"	\$25,275.00	
ADD FOR OPTIONS:		
-12.....*POA	-49.....\$246.00	-C.....\$0.00
-12-1.....*POA	-50.....246.00	-T.....129.00
-12-2.....*POA	-66**.....612.00	-TSI†.....*POA
-15.....393.00	-80.....4,636.00	-VP.....342.00
-19.....3,253.00	-84.....930.00	-X.....0.00
-20.....2,713.00	-92.....4,866.00	
* PRICE ON APPLICATION † Available up to 4" only		
**2" - 6"		

	8" SQUARE TOP	
	LIST PRICE	
PIPE SIZE	35100	
2" - 4"	\$1,365.00	
ADD FOR OPTIONS:		
-1.....\$1,015.00	-50.....STD	-TS0.....\$361.00
-2.....753.00	-92.....696.00	-X.....0.00
-7.....345.00	-ARE.....831.00	-Y.....0.00
-15.....393.00	-T.....129.00	-YGTC (2"-4") 41.00
-49.....269.00	-TSI.....POA	-Z.....0.00

	9" TOP w/BUCKET	
	LIST PRICE	
PIPE SIZE	35130	
2" - 4"	\$1,594.00	
ADD FOR OPTIONS:		
-1.....\$1,037.00	-50.....\$246.00	-TSI.....POA
-2.....753.00	-66.....257.00	-VP.....246.00
-14-1.....2,725.00	-70.....Ded. 129.00	-X.....0.00
-14-2.....2,577.00	-84.....342.00	-Z.....0.00
-15.....402.00	-92.....702.00	
-49.....246.00	-ARE.....\$1,214.00	









	10" TRACTOR TOP w/BUCKET	
	LIST PRICE	
PIPE SIZE	35170	
3" - 4"	\$1,915.00	
ADD FOR OPTIONS:		
-1.....\$1,594.00	-70.....Ded. 160.00	-VP.....\$246.00
-2.....1,342.00	-84.....452.00	-X.....0.00
-15.....393.00	-88.....90.00	-Z.....0.00
-49.....269.00	-92.....568.00	
-50.....269.00	-TSI.....POA	

Option Descriptions

- AE LEVELEZE® Adjustable Extension
- ARE Acid Resisting Epoxy
- C Bolted Flashing Clamp Device
- HP Heel-Proof Grate
- HP-7 Heel-Proof Grate, Ductile Iron
- LC1 Locking Cover, Satin Finish Nikaloy
- LC2 Locking Cover, Satin Finish Bronze
- LT Less Shallow Trap
- OR LEVELEZE® Adjustable Extension with O-Ring
- PFB Pre-Fabricated Base
- SD Special Duty Grate
- SD-19 Special Duty, C.I. Undergrate with Satin Finish Nikaloy Top
- SD-20 Special Duty, C.I. Undergrate with Satin Finish Bronze Top
- SQ Square Top
- TG Tractor Grate
- TSI Trap Seal Insert
- VP Secured Grate, Vandal-Proof Screws
- 1 Satin Finish Nikaloy Top
- 2 Satin Finish Bronze Top
- 4 Secondary Flashing Clamp (use with -AE only)
- 7 Ductile Iron Grate
- 11 Extra-Heavy Grate, Cast Iron
- 12 Square Top, Cast Iron
- 12-1 Square Top, Nikaloy
- 12-2 Square Top, Bronze
- 13 Dome Grate, Cast Iron
- 13-1 Dome Grate, Nikaloy
- 13-2 Dome Grate, Bronze
- 14-1 Hinged Top, Satin Finish Nikaloy
- 14-2 Hinged Top, Satin Finish Bronze
- 15 Chained Grate
- 19 C.I. Undergrate with Satin Finish Nikaloy Top
- 20 C.I. Undergrate with Satin Finish Bronze Top
- 39 Solid Cast Iron Cover
- 44 Fixed Extension Collar, Cast Iron, Specify Height
- 44-92 Fixed Extension Collar, Galvanized, Specify Height
- 49 3/4" Primer Tap
- 50 1/2" Primer Tap
- 51 1-1/2" Auxiliary Threaded Inlet
- 52 2" Auxiliary Threaded Inlet
- 53 2" Auxiliary Hub Inlet
- 54 2" Auxiliary Spigot Inlet
- 53-92 2" Auxiliary Hub Inlet, Galvanized
- 54-92 2" Auxiliary Spigot Inlet, Galvanized
- 60 Backwater Valve
- 62 "T" Handle Bronze Closure Plug
- 70 Less Bucket
- 71 Solid Cast Iron Bucket
- 80 Perforated Stainless Steel Basket
- 81 Slotted Cast Iron Bucket
- 84 Stainless Steel Mesh Bucket Liner
- 88 Supplementary Strainer
- 92 Galvanized Cast Iron Parts

Outlets

- 66 No-Hub Side Outlet
- T Threaded Outlet
- TSO Threaded Side Outlet
- X Inside Caulk Outlet
- Y Hub Outlet with Gasket, 2" - 4"
- YGTC -Y Outlet Gasket with Test Cap
- Z No-Hub Outlet

 <p>37800</p>	<p>SHALLOW SUMP, 12" HEAVY-DUTY TOP</p> <table border="1"> <thead> <tr> <th colspan="2">LIST PRICE</th> </tr> </thead> <tbody> <tr> <td>PIPE SIZE</td> <td>37800</td> </tr> <tr> <td>2" - 4"</td> <td>\$2,318.00</td> </tr> </tbody> </table> <p>ADD FOR OPTIONS:</p> <table> <tr> <td>-7.....\$969.00</td> <td>-50..... STD</td> <td>-X.....0.00</td> </tr> <tr> <td>-14.....393.00</td> <td>-66.....356.00</td> <td>-Y.....0.00</td> </tr> <tr> <td>-18.....908.00</td> <td>-92.....817.00</td> <td>-YGTC (2"-4") 41.00</td> </tr> <tr> <td>-19.....1,818.00</td> <td>-T.....129.00</td> <td>-Z.....0.00</td> </tr> <tr> <td>-20.....1,504.00</td> <td>-TSI†..... POA</td> <td></td> </tr> <tr> <td>-49.....\$269.00</td> <td>-VP.....240.00</td> <td></td> </tr> </table>	LIST PRICE		PIPE SIZE	37800	2" - 4"	\$2,318.00	-7.....\$969.00	-50..... STD	-X.....0.00	-14.....393.00	-66.....356.00	-Y.....0.00	-18.....908.00	-92.....817.00	-YGTC (2"-4") 41.00	-19.....1,818.00	-T.....129.00	-Z.....0.00	-20.....1,504.00	-TSI†..... POA		-49.....\$269.00	-VP.....240.00		 <p>37900</p>	<p>14" PACKING HOUSE DRAIN</p> <table border="1"> <thead> <tr> <th colspan="2">LIST PRICE</th> </tr> </thead> <tbody> <tr> <td>PIPE SIZE</td> <td>37900</td> </tr> <tr> <td>2" - 6" 8"</td> <td>\$4,895.00 5,519.00</td> </tr> </tbody> </table> <p>ADD FOR OPTIONS:</p> <table> <tr> <td>-4.....\$310.00</td> <td>-84.....\$694.00</td> <td>-VP.....\$245.00</td> </tr> <tr> <td>-15.....402.00</td> <td>-88.....127.00</td> <td>-X.....0.00</td> </tr> <tr> <td>-19.....2,225.00</td> <td>-92.....2,802.00</td> <td>-Y.....0.00</td> </tr> <tr> <td>-20.....2,117.00</td> <td>-T.....129.00</td> <td>-YGTC (2"-4") 41.00</td> </tr> <tr> <td>-70.....Ded. 300.00</td> <td>-TSI†..... POA</td> <td>-Z.....0.00</td> </tr> </table>	LIST PRICE		PIPE SIZE	37900	2" - 6" 8"	\$4,895.00 5,519.00	-4.....\$310.00	-84.....\$694.00	-VP.....\$245.00	-15.....402.00	-88.....127.00	-X.....0.00	-19.....2,225.00	-92.....2,802.00	-Y.....0.00	-20.....2,117.00	-T.....129.00	-YGTC (2"-4") 41.00	-70.....Ded. 300.00	-TSI†..... POA	-Z.....0.00															
LIST PRICE																																																															
PIPE SIZE	37800																																																														
2" - 4"	\$2,318.00																																																														
-7.....\$969.00	-50..... STD	-X.....0.00																																																													
-14.....393.00	-66.....356.00	-Y.....0.00																																																													
-18.....908.00	-92.....817.00	-YGTC (2"-4") 41.00																																																													
-19.....1,818.00	-T.....129.00	-Z.....0.00																																																													
-20.....1,504.00	-TSI†..... POA																																																														
-49.....\$269.00	-VP.....240.00																																																														
LIST PRICE																																																															
PIPE SIZE	37900																																																														
2" - 6" 8"	\$4,895.00 5,519.00																																																														
-4.....\$310.00	-84.....\$694.00	-VP.....\$245.00																																																													
-15.....402.00	-88.....127.00	-X.....0.00																																																													
-19.....2,225.00	-92.....2,802.00	-Y.....0.00																																																													
-20.....2,117.00	-T.....129.00	-YGTC (2"-4") 41.00																																																													
-70.....Ded. 300.00	-TSI†..... POA	-Z.....0.00																																																													
 <p>37810</p>	<p>MEDIUM SUMP, 12" HEAVY-DUTY TOP</p> <table border="1"> <thead> <tr> <th colspan="2">LIST PRICE</th> </tr> </thead> <tbody> <tr> <td>PIPE SIZE</td> <td>37810</td> </tr> <tr> <td>2" - 6"</td> <td>\$2,464.00</td> </tr> </tbody> </table> <p>ADD FOR OPTIONS:</p> <table> <tr> <td>-4*.....\$310.00</td> <td>-49.....\$246.00</td> <td>-AE.....\$1,174.00</td> </tr> <tr> <td>-7.....996.00</td> <td>-50.....246.00</td> <td>-ARE.....1,524.00</td> </tr> <tr> <td>-14.....393.00</td> <td>-66.....612.00</td> <td>-T.....129.00</td> </tr> <tr> <td>-18.....908.00</td> <td>-70.....Ded. 274.00</td> <td>-TSI†.....POA</td> </tr> <tr> <td>-19.....1,818.00</td> <td>-84.....694.00</td> <td>-VP.....240.00</td> </tr> <tr> <td>-20.....1,504.00</td> <td>-88.....154.00</td> <td>-X.....0.00</td> </tr> <tr> <td>-39.....686.00</td> <td>-92.....1,471.00</td> <td>-Y.....0.00</td> </tr> <tr> <td></td> <td></td> <td>-YGTC (2"-4") 41.00</td> </tr> <tr> <td></td> <td></td> <td>-Z.....0.00</td> </tr> </table> <p>* Available on -AE only †Available up to 4" only</p>	LIST PRICE		PIPE SIZE	37810	2" - 6"	\$2,464.00	-4*.....\$310.00	-49.....\$246.00	-AE.....\$1,174.00	-7.....996.00	-50.....246.00	-ARE.....1,524.00	-14.....393.00	-66.....612.00	-T.....129.00	-18.....908.00	-70.....Ded. 274.00	-TSI†.....POA	-19.....1,818.00	-84.....694.00	-VP.....240.00	-20.....1,504.00	-88.....154.00	-X.....0.00	-39.....686.00	-92.....1,471.00	-Y.....0.00			-YGTC (2"-4") 41.00			-Z.....0.00	 <p>37960</p>	<p>SUPER-FLO® 16" TOP</p> <table border="1"> <thead> <tr> <th colspan="2">LIST PRICE</th> </tr> </thead> <tbody> <tr> <td>PIPE SIZE</td> <td>37960</td> </tr> <tr> <td>2" - 6"</td> <td>\$4,213.00</td> </tr> </tbody> </table> <p>ADD FOR OPTIONS:</p> <table> <tr> <td>-1.....\$4,875.00</td> <td>-81.....\$972.00</td> <td>-LF.....Ded. \$614.00</td> </tr> <tr> <td>-2.....4,381.00</td> <td>-84.....694.00</td> <td>-LG.....Ded. 936.00</td> </tr> <tr> <td>-7.....1,007.00</td> <td>-92.....2,082.00</td> <td>-LG-1Ded. 1,955.00</td> </tr> <tr> <td>-11.....1,007.00</td> <td>-92-LF.....1,750.00</td> <td>-LG-2.....Ded. 1,822.00</td> </tr> <tr> <td>-15.....402.00</td> <td>-92-LG-LF.....1,594.00</td> <td>-TSI†.....POA</td> </tr> <tr> <td>-49.....312.00</td> <td>-ARE.....See 49405</td> <td>-VP*.....127.00</td> </tr> <tr> <td>-50.....312.00</td> <td>-C.....930.00</td> <td>-X.....0.00</td> </tr> </table> <p>†Available up to 4" only *Only available with -1 or -2</p>	LIST PRICE		PIPE SIZE	37960	2" - 6"	\$4,213.00	-1.....\$4,875.00	-81.....\$972.00	-LF.....Ded. \$614.00	-2.....4,381.00	-84.....694.00	-LG.....Ded. 936.00	-7.....1,007.00	-92.....2,082.00	-LG-1Ded. 1,955.00	-11.....1,007.00	-92-LF.....1,750.00	-LG-2.....Ded. 1,822.00	-15.....402.00	-92-LG-LF.....1,594.00	-TSI†.....POA	-49.....312.00	-ARE.....See 49405	-VP*.....127.00	-50.....312.00	-C.....930.00	-X.....0.00
LIST PRICE																																																															
PIPE SIZE	37810																																																														
2" - 6"	\$2,464.00																																																														
-4*.....\$310.00	-49.....\$246.00	-AE.....\$1,174.00																																																													
-7.....996.00	-50.....246.00	-ARE.....1,524.00																																																													
-14.....393.00	-66.....612.00	-T.....129.00																																																													
-18.....908.00	-70.....Ded. 274.00	-TSI†.....POA																																																													
-19.....1,818.00	-84.....694.00	-VP.....240.00																																																													
-20.....1,504.00	-88.....154.00	-X.....0.00																																																													
-39.....686.00	-92.....1,471.00	-Y.....0.00																																																													
		-YGTC (2"-4") 41.00																																																													
		-Z.....0.00																																																													
LIST PRICE																																																															
PIPE SIZE	37960																																																														
2" - 6"	\$4,213.00																																																														
-1.....\$4,875.00	-81.....\$972.00	-LF.....Ded. \$614.00																																																													
-2.....4,381.00	-84.....694.00	-LG.....Ded. 936.00																																																													
-7.....1,007.00	-92.....2,082.00	-LG-1Ded. 1,955.00																																																													
-11.....1,007.00	-92-LF.....1,750.00	-LG-2.....Ded. 1,822.00																																																													
-15.....402.00	-92-LG-LF.....1,594.00	-TSI†.....POA																																																													
-49.....312.00	-ARE.....See 49405	-VP*.....127.00																																																													
-50.....312.00	-C.....930.00	-X.....0.00																																																													
 <p>37820</p>	<p>DEEP SUMP, 12" HEAVY-DUTY TOP w/BUCKET</p> <table border="1"> <thead> <tr> <th colspan="2">LIST PRICE</th> </tr> </thead> <tbody> <tr> <td>PIPE SIZE</td> <td>37820</td> </tr> <tr> <td>2" - 8"</td> <td>\$2,832.00</td> </tr> </tbody> </table> <p>ADD FOR OPTIONS:</p> <table> <tr> <td>-4*.....\$310.00</td> <td>-49.....\$246.00</td> <td>-AE.....\$1,174.00</td> </tr> <tr> <td>-7.....996.00</td> <td>-50.....246.00</td> <td>-ARE.....1,610.00</td> </tr> <tr> <td>-14.....393.00</td> <td>-66**.....612.00</td> <td>-TSI†.....POA</td> </tr> <tr> <td>-18.....908.00</td> <td>-70.....Ded. 274.00</td> <td>-VP.....240.00</td> </tr> <tr> <td>-19.....1,818.00</td> <td>-84.....694.00</td> <td>-X.....0.00</td> </tr> <tr> <td>-20.....1,504.00</td> <td>-88.....154.00</td> <td>-Z.....0.00</td> </tr> <tr> <td>-39.....686.00</td> <td>-92.....1,471.00</td> <td></td> </tr> </table> <p>* Available on -AE only †Available up to 4" only ** 2" - 6"</p>	LIST PRICE		PIPE SIZE	37820	2" - 8"	\$2,832.00	-4*.....\$310.00	-49.....\$246.00	-AE.....\$1,174.00	-7.....996.00	-50.....246.00	-ARE.....1,610.00	-14.....393.00	-66**.....612.00	-TSI†.....POA	-18.....908.00	-70.....Ded. 274.00	-VP.....240.00	-19.....1,818.00	-84.....694.00	-X.....0.00	-20.....1,504.00	-88.....154.00	-Z.....0.00	-39.....686.00	-92.....1,471.00		 <p>38040</p>	<p>ROUND TOP & CLEANOUT</p> <table border="1"> <thead> <tr> <th colspan="2">LIST PRICE</th> </tr> </thead> <tbody> <tr> <td>PIPE SIZE</td> <td>38040</td> </tr> <tr> <td>2"</td> <td>\$2,079.00</td> </tr> <tr> <td>3"</td> <td>3,268.00</td> </tr> <tr> <td>4"</td> <td>3,432.00</td> </tr> </tbody> </table> <p>ADD FOR OPTIONS:</p> <table> <tr> <td>-1.....\$1,263.00</td> <td>-51.....\$572.00</td> <td>-84.....478.00</td> </tr> <tr> <td>-2.....1,156.00</td> <td>-52.....572.00</td> <td>-88.....69.00</td> </tr> <tr> <td>-7.....416.00</td> <td>-60* (2").....993.00</td> <td>-92.....1,244.00</td> </tr> <tr> <td>-11.....106.00</td> <td>-60* (3").....1,096.00</td> <td>-TSI.....POA</td> </tr> <tr> <td>-15.....389.00</td> <td>-60* (4").....1,197.00</td> <td>-VP.....240.00</td> </tr> <tr> <td>-49.....246.00</td> <td>-81.....205.00</td> <td>-Z.....0.00</td> </tr> <tr> <td>-50.....246.00</td> <td>-81-92.....\$345.00</td> <td></td> </tr> </table> <p>Note: When ordering/using a -81 option, the -7 and -11 options can not be used. *Can not be used with TSI</p>	LIST PRICE		PIPE SIZE	38040	2"	\$2,079.00	3"	3,268.00	4"	3,432.00	-1.....\$1,263.00	-51.....\$572.00	-84.....478.00	-2.....1,156.00	-52.....572.00	-88.....69.00	-7.....416.00	-60* (2").....993.00	-92.....1,244.00	-11.....106.00	-60* (3").....1,096.00	-TSI.....POA	-15.....389.00	-60* (4").....1,197.00	-VP.....240.00	-49.....246.00	-81.....205.00	-Z.....0.00	-50.....246.00	-81-92.....\$345.00			
LIST PRICE																																																															
PIPE SIZE	37820																																																														
2" - 8"	\$2,832.00																																																														
-4*.....\$310.00	-49.....\$246.00	-AE.....\$1,174.00																																																													
-7.....996.00	-50.....246.00	-ARE.....1,610.00																																																													
-14.....393.00	-66**.....612.00	-TSI†.....POA																																																													
-18.....908.00	-70.....Ded. 274.00	-VP.....240.00																																																													
-19.....1,818.00	-84.....694.00	-X.....0.00																																																													
-20.....1,504.00	-88.....154.00	-Z.....0.00																																																													
-39.....686.00	-92.....1,471.00																																																														
LIST PRICE																																																															
PIPE SIZE	38040																																																														
2"	\$2,079.00																																																														
3"	3,268.00																																																														
4"	3,432.00																																																														
-1.....\$1,263.00	-51.....\$572.00	-84.....478.00																																																													
-2.....1,156.00	-52.....572.00	-88.....69.00																																																													
-7.....416.00	-60* (2").....993.00	-92.....1,244.00																																																													
-11.....106.00	-60* (3").....1,096.00	-TSI.....POA																																																													
-15.....389.00	-60* (4").....1,197.00	-VP.....240.00																																																													
-49.....246.00	-81.....205.00	-Z.....0.00																																																													
-50.....246.00	-81-92.....\$345.00																																																														
 <p>37830</p>	<p>12" TOP w/LATCHING GRATE</p> <table border="1"> <thead> <tr> <th colspan="2">LIST PRICE</th> </tr> </thead> <tbody> <tr> <td>PIPE SIZE</td> <td>37830</td> </tr> <tr> <td>2" - 6"</td> <td>\$3,375.00</td> </tr> </tbody> </table> <p>ADD FOR OPTIONS:</p> <table> <tr> <td>-7.....\$996.00</td> <td>-39.....\$686.00</td> <td>-84.....\$694.00</td> </tr> <tr> <td>-19.....1,818.00</td> <td>-49.....246.00</td> <td>-92.....1,471.00</td> </tr> <tr> <td>-20.....1,504.00</td> <td>-50.....246.00</td> <td>-TSI†.....POA</td> </tr> <tr> <td>-21.....Ded. 775.00</td> <td>-66.....612.00</td> <td>-X.....0.00</td> </tr> <tr> <td>-22.....Ded. 512.00</td> <td>-69.....129.00</td> <td>-Z.....0.00</td> </tr> </table> <p>†Available up to 4" only</p>	LIST PRICE		PIPE SIZE	37830	2" - 6"	\$3,375.00	-7.....\$996.00	-39.....\$686.00	-84.....\$694.00	-19.....1,818.00	-49.....246.00	-92.....1,471.00	-20.....1,504.00	-50.....246.00	-TSI†.....POA	-21.....Ded. 775.00	-66.....612.00	-X.....0.00	-22.....Ded. 512.00	-69.....129.00	-Z.....0.00	 <p>38250A</p>	<p>ROUND TOP w/CLEANOUT & BWV</p> <table border="1"> <thead> <tr> <th colspan="2">LIST PRICE</th> </tr> </thead> <tbody> <tr> <td>PIPE SIZE</td> <td>38250A</td> </tr> <tr> <td>2"</td> <td>\$1,401.00</td> </tr> <tr> <td>3"</td> <td>1,919.00</td> </tr> <tr> <td>4"</td> <td>2,700.00</td> </tr> </tbody> </table> <p>ADD FOR OPTIONS:</p> <table> <tr> <td>-1 (2" - 3").....\$683.00</td> <td>-61 (2").....Deduct \$154.00</td> </tr> <tr> <td>-1 (4").....1,610.00</td> <td>-61 (3", 4").....Deduct 315.00</td> </tr> <tr> <td>-2 (2" - 3").....614.00</td> <td>-92.....807.00</td> </tr> <tr> <td>-2 (4").....1,454.00</td> <td>-VP.....240.00</td> </tr> <tr> <td>-15.....393.00</td> <td>-Z.....0.00</td> </tr> </table>	LIST PRICE		PIPE SIZE	38250A	2"	\$1,401.00	3"	1,919.00	4"	2,700.00	-1 (2" - 3").....\$683.00	-61 (2").....Deduct \$154.00	-1 (4").....1,610.00	-61 (3", 4").....Deduct 315.00	-2 (2" - 3").....614.00	-92.....807.00	-2 (4").....1,454.00	-VP.....240.00	-15.....393.00	-Z.....0.00																			
LIST PRICE																																																															
PIPE SIZE	37830																																																														
2" - 6"	\$3,375.00																																																														
-7.....\$996.00	-39.....\$686.00	-84.....\$694.00																																																													
-19.....1,818.00	-49.....246.00	-92.....1,471.00																																																													
-20.....1,504.00	-50.....246.00	-TSI†.....POA																																																													
-21.....Ded. 775.00	-66.....612.00	-X.....0.00																																																													
-22.....Ded. 512.00	-69.....129.00	-Z.....0.00																																																													
LIST PRICE																																																															
PIPE SIZE	38250A																																																														
2"	\$1,401.00																																																														
3"	1,919.00																																																														
4"	2,700.00																																																														
-1 (2" - 3").....\$683.00	-61 (2").....Deduct \$154.00																																																														
-1 (4").....1,610.00	-61 (3", 4").....Deduct 315.00																																																														
-2 (2" - 3").....614.00	-92.....807.00																																																														
-2 (4").....1,454.00	-VP.....240.00																																																														
-15.....393.00	-Z.....0.00																																																														
 <p>37840</p>	<p>12" TOP w/BUCKET</p> <table border="1"> <thead> <tr> <th colspan="2">LIST PRICE</th> </tr> </thead> <tbody> <tr> <td>PIPE SIZE</td> <td>37840</td> </tr> <tr> <td>2" - 8"</td> <td>\$4,895.00</td> </tr> </tbody> </table> <p>ADD FOR OPTIONS:</p> <table> <tr> <td>-7.....\$996.00</td> <td>-50.....\$246.00</td> <td>-TSI†.....POA</td> </tr> <tr> <td>-14.....393.00</td> <td>-66*.....612.00</td> <td>-VP.....240.00</td> </tr> <tr> <td>-19.....1,818.00</td> <td>-70.....Ded. 274.00</td> <td>-X.....0.00</td> </tr> <tr> <td>-20.....1,504.00</td> <td>-84.....694.00</td> <td>-Z.....0.00</td> </tr> <tr> <td>-39.....686.00</td> <td>-88.....154.00</td> <td></td> </tr> <tr> <td>-49.....246.00</td> <td>-92.....1,471.00</td> <td></td> </tr> </table> <p>* 2" - 6" †Available up to 4" only</p>	LIST PRICE		PIPE SIZE	37840	2" - 8"	\$4,895.00	-7.....\$996.00	-50.....\$246.00	-TSI†.....POA	-14.....393.00	-66*.....612.00	-VP.....240.00	-19.....1,818.00	-70.....Ded. 274.00	-X.....0.00	-20.....1,504.00	-84.....694.00	-Z.....0.00	-39.....686.00	-88.....154.00		-49.....246.00	-92.....1,471.00																																							
LIST PRICE																																																															
PIPE SIZE	37840																																																														
2" - 8"	\$4,895.00																																																														
-7.....\$996.00	-50.....\$246.00	-TSI†.....POA																																																													
-14.....393.00	-66*.....612.00	-VP.....240.00																																																													
-19.....1,818.00	-70.....Ded. 274.00	-X.....0.00																																																													
-20.....1,504.00	-84.....694.00	-Z.....0.00																																																													
-39.....686.00	-88.....154.00																																																														
-49.....246.00	-92.....1,471.00																																																														

FLOOR DRAINS

	NON-CLOG w/CLEANOUT & BUCKET		
	LIST PRICE		
	PIPE SIZE	38420	
	3", 4"	\$26,441.00	
ADD FOR OPTIONS:			
-1	\$6,603.00	-92	\$5,745.00
-2	5,939.00	-C	879.00
-15	402.00	-IGS	31,481.00
-60	1,610.00	-VP	393.00
-84	694.00		

	22" x 14" TOP, INTERNAL DOME STRAINER		
	LIST PRICE		
	PIPE SIZE	38850	
	3" - 6"	\$10,166.00	
ADD FOR OPTIONS:			
-7	\$3,268.00	-TSH	POA
-15	402.00	-VP	393.00
-92	5,453.00	-X	0.00
†Available up to 4" only			

	13" X 11" TOP w/HINGED GRATE		
	LIST PRICE		
	PIPE SIZE	38620-40	
	3" 4"	\$8,099.00 8,929.00	
ADD FOR OPTIONS:			
-1 (3")	\$2,430.00	-33	\$612.00
-1 (4")	2,645.00	-49	246.00
-2 (3")	1,972.00	-50	246.00
-2 (4")	2,176.00	-60* (3")	1,100.00
-7	1,007.00	-60* (4")	1,199.00
		-70	Ded. \$274.00
		-84	694.00
		-92	3,159.00
		-TSI	POA
		-VP	240.00
*Can not be used with TSI			

	21" x 14 1/2" TOP, CLEANOUT & BUCKET		
	LIST PRICE		
	PIPE SIZE	38930	
	3", 4"	\$5,883.00	
ADD FOR OPTIONS:			
-7	\$1,015.00	-C	\$647.00
-15	402.00	-VP	245.00
-84	694.00	-X	0.00
-92	2,646.00		





	13" x 11" TOP w/BUCKET		
	LIST PRICE		
	PIPE SIZE	38640	
	2" - 4"	\$3,689.00	
ADD FOR OPTIONS:			
-1	\$2,221.00	-84	\$694.00
-2	1,843.00	-92	1,652.00
-7	1,015.00	-VP	245.00
-70	Ded. 263.00		

Option Descriptions

- AE LEVELEZE® Adjustable Extension
- ARE Acid Resisting Epoxy
- C Bolted Flashing Clamp Device
- IGS Internal Gas Seal
- LF Less Double Drainage Flange
- LG Less Grate, Cast Iron
- LG-1 Less Grate, Nikaloy
- LG-2 Less Grate, Bronze
- TSI Trap Seal Insert
- VP Secured Grate, Vandal-Proof Screws
- 1 Satin Finish Nikaloy Top
- 2 Satin Finish Bronze Top
- 4 Secondary Flashing Clamp (use with -AE only)
- 7 Ductile Iron Grate
- 11 Extra-Heavy Grate, Cast Iron
- 14 Hinged Grate
- 15 Chained Grate
- 18 Hinged Grate with Latching Device
- 19 C.I. Undergrate with Satin Finish Nikaloy Top
- 20 C.I. Undergrate with Satin Finish Bronze Top
- 21 Loose-Set Grate
- 22 Less Latching Device
- 33 Galvanized Bucket Only
- 39 Solid Cast Iron Cover
- 49 3/4" Primer Tap
- 50 1/2" Primer Tap
- 51 1-1/2" Auxiliary Threaded Inlet
- 52 2" Auxiliary Threaded Inlet
- 60 Backwater Valve
- 61 Less Backwater Valve
- 69 Lift Handle for Sediment Bucket
- 70 Less Bucket
- 74 Aluminum Bucket
- 81 Slotted Cast Iron Bucket
- 81-92 Slotted Cast Iron Bucket, Galvanized
- 84 Stainless Steel Mesh Bucket Liner
- 88 Supplementary Strainer
- 92 Galvanized Cast Iron Parts
- 92-LF Galv. C.I. Parts, Less Double Drainage Flange
- 92-LG-LF Galv. C.I. Parts, Less Grate and Flange
- Outlets**
- 66 No-Hub Side Outlet
- T Threaded Outlet
- X Inside Caulk Outlet
- Y Hub Outlet with Gasket, 2" - 4"
- Z No-Hub Outlet

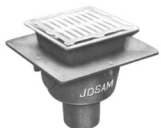
	15" x 13" TOP, TRACTOR GRATE		
	LIST PRICE		
	PIPE SIZE	38820	
	3", 4"	\$5,725.00	
ADD FOR OPTIONS:			
-1	\$2,426.00	-49	\$246.00
-2	2,187.00	-50	246.00
-7	996.00	-66	612.00
-15	402.00	-74	614.00
		-84	\$694.00
		-92	1,535.00
		-TSI	POA
		-X	0.00
		-Z	0.00

	13-3/4" x 14-1/8" TOP w/HINGED GRATE		
	LIST PRICE		
	PIPE SIZE	38830	
	3", 4"	\$6,119.00	
ADD FOR OPTIONS:			
-1	\$1,818.00	-50	\$246.00
-2	1,358.00	-84	694.00
-7	1,015.00	-92	2,415.00
-49	246.00	-VP	240.00

 <p>39240</p>	<p align="center">SQUARE CAN WASH DRAIN</p> <table border="1"> <thead> <tr> <th colspan="2">LIST PRICE</th> </tr> </thead> <tbody> <tr> <td>PIPE SIZE</td> <td align="center">39240</td> </tr> <tr> <td>3" - 4"</td> <td align="center">\$4,669.00</td> </tr> </tbody> </table> <p>ADD FOR OPTIONS:</p> <table> <tr> <td>-1.....\$1,315.00</td> <td>-C.....\$0.00</td> <td>-92.....\$1,710.00</td> </tr> <tr> <td>-2.....1,156.00</td> <td>-TSI.....POA</td> <td>-X.....0.00</td> </tr> <tr> <td>-15.....402.00</td> <td>-66.....612.00</td> <td>-Z.....0.00</td> </tr> <tr> <td></td> <td>-84.....775.00</td> <td></td> </tr> </table>	LIST PRICE		PIPE SIZE	39240	3" - 4"	\$4,669.00	-1.....\$1,315.00	-C.....\$0.00	-92.....\$1,710.00	-2.....1,156.00	-TSI.....POA	-X.....0.00	-15.....402.00	-66.....612.00	-Z.....0.00		-84.....775.00		 <p>49300</p>	<p align="center">SUPER-FLO® 8" SQUARE TOP, 6" DEEP</p> <table border="1"> <thead> <tr> <th colspan="5">LIST PRICE</th> </tr> </thead> <tbody> <tr> <td>PIPE SIZE</td> <td>49300</td> <td>49300-LF</td> <td>49300-NB</td> <td>49300-LF-NB</td> </tr> <tr> <td>2" - 4"</td> <td align="center">\$2,912.00</td> <td align="center">\$2,612.00</td> <td align="center">\$3,618.00</td> <td align="center">\$3,318.00</td> </tr> </tbody> </table> <p>ADD FOR OPTIONS:</p> <table> <tr> <td>-3.....\$0.00</td> <td>-43.....\$516.00</td> </tr> <tr> <td>-4.....0.00</td> <td>-45.....Deduct 100.00</td> </tr> <tr> <td>-7.....296.00</td> <td>-55**.....312.00</td> </tr> <tr> <td>-8.....312.00</td> <td>-C.....245.00</td> </tr> <tr> <td>-16 (ARE).....627.00</td> <td>-HG.....584.00</td> </tr> <tr> <td>-16 (NB).....702.00</td> <td>-LF.....Deduct 299.00</td> </tr> <tr> <td>-17 (ARE).....807.00</td> <td>-LG (ARE).....Deduct 312.00</td> </tr> <tr> <td>-17 (NB).....1,038.00</td> <td>-LG (NB).....Deduct 501.00</td> </tr> <tr> <td>-18 (ARE).....874.00</td> <td>-NB.....707.00</td> </tr> <tr> <td>-18 (NB).....1,457.00</td> <td>-PFB.....260.00</td> </tr> <tr> <td>-20 (NB).....373.00</td> <td>-TSI.....POA</td> </tr> <tr> <td>-24 (NB).....356.00</td> <td>-VP (NB).....127.00</td> </tr> <tr> <td>-31.....333.00</td> <td>-X.....0.00</td> </tr> <tr> <td>-33.....707.00</td> <td>-Y†.....0.00</td> </tr> <tr> <td>-35*.....775.00</td> <td>-YGTC (3"-4").....41.00</td> </tr> <tr> <td></td> <td>-Z.....0.00</td> </tr> </table> <p>*Specify -31 or -33 Bucket ** 88450 Provided † -Y Outlet only available on 3" -LF and 4" -LF</p>	LIST PRICE					PIPE SIZE	49300	49300-LF	49300-NB	49300-LF-NB	2" - 4"	\$2,912.00	\$2,612.00	\$3,618.00	\$3,318.00	-3.....\$0.00	-43.....\$516.00	-4.....0.00	-45.....Deduct 100.00	-7.....296.00	-55**.....312.00	-8.....312.00	-C.....245.00	-16 (ARE).....627.00	-HG.....584.00	-16 (NB).....702.00	-LF.....Deduct 299.00	-17 (ARE).....807.00	-LG (ARE).....Deduct 312.00	-17 (NB).....1,038.00	-LG (NB).....Deduct 501.00	-18 (ARE).....874.00	-NB.....707.00	-18 (NB).....1,457.00	-PFB.....260.00	-20 (NB).....373.00	-TSI.....POA	-24 (NB).....356.00	-VP (NB).....127.00	-31.....333.00	-X.....0.00	-33.....707.00	-Y†.....0.00	-35*.....775.00	-YGTC (3"-4").....41.00		-Z.....0.00																																														
LIST PRICE																																																																																																																		
PIPE SIZE	39240																																																																																																																	
3" - 4"	\$4,669.00																																																																																																																	
-1.....\$1,315.00	-C.....\$0.00	-92.....\$1,710.00																																																																																																																
-2.....1,156.00	-TSI.....POA	-X.....0.00																																																																																																																
-15.....402.00	-66.....612.00	-Z.....0.00																																																																																																																
	-84.....775.00																																																																																																																	
LIST PRICE																																																																																																																		
PIPE SIZE	49300	49300-LF	49300-NB	49300-LF-NB																																																																																																														
2" - 4"	\$2,912.00	\$2,612.00	\$3,618.00	\$3,318.00																																																																																																														
-3.....\$0.00	-43.....\$516.00																																																																																																																	
-4.....0.00	-45.....Deduct 100.00																																																																																																																	
-7.....296.00	-55**.....312.00																																																																																																																	
-8.....312.00	-C.....245.00																																																																																																																	
-16 (ARE).....627.00	-HG.....584.00																																																																																																																	
-16 (NB).....702.00	-LF.....Deduct 299.00																																																																																																																	
-17 (ARE).....807.00	-LG (ARE).....Deduct 312.00																																																																																																																	
-17 (NB).....1,038.00	-LG (NB).....Deduct 501.00																																																																																																																	
-18 (ARE).....874.00	-NB.....707.00																																																																																																																	
-18 (NB).....1,457.00	-PFB.....260.00																																																																																																																	
-20 (NB).....373.00	-TSI.....POA																																																																																																																	
-24 (NB).....356.00	-VP (NB).....127.00																																																																																																																	
-31.....333.00	-X.....0.00																																																																																																																	
-33.....707.00	-Y†.....0.00																																																																																																																	
-35*.....775.00	-YGTC (3"-4").....41.00																																																																																																																	
	-Z.....0.00																																																																																																																	
 <p>39600</p>	<p align="center">PLANTING AREA DRAIN</p> <table border="1"> <thead> <tr> <th colspan="2">LIST PRICE</th> </tr> </thead> <tbody> <tr> <td>PIPE SIZE</td> <td align="center">39600</td> </tr> <tr> <td>2" - 6"</td> <td align="center">\$1,808.00</td> </tr> </tbody> </table> <p>ADD FOR OPTIONS:</p> <table> <tr> <td>-66.....\$612.00</td> <td>-T.....\$129.00</td> <td>-Z.....\$0.00</td> </tr> <tr> <td>-89.....246.00</td> <td>-TS†.....POA</td> <td></td> </tr> <tr> <td>-92.....647.00</td> <td>-X.....0.00</td> <td></td> </tr> </table> <p>†Available up to 4" only</p>	LIST PRICE		PIPE SIZE	39600	2" - 6"	\$1,808.00	-66.....\$612.00	-T.....\$129.00	-Z.....\$0.00	-89.....246.00	-TS†.....POA		-92.....647.00	-X.....0.00																																																																																																			
LIST PRICE																																																																																																																		
PIPE SIZE	39600																																																																																																																	
2" - 6"	\$1,808.00																																																																																																																	
-66.....\$612.00	-T.....\$129.00	-Z.....\$0.00																																																																																																																
-89.....246.00	-TS†.....POA																																																																																																																	
-92.....647.00	-X.....0.00																																																																																																																	
 <p>39720</p>	<p align="center">11" TOP COMPOSITION DECK FLANGE</p> <table border="1"> <thead> <tr> <th colspan="2">LIST PRICE</th> </tr> </thead> <tbody> <tr> <td>PIPE SIZE</td> <td align="center">39720</td> </tr> <tr> <td>2" - 4"</td> <td align="center">\$3,341.00</td> </tr> </tbody> </table> <p>ADD FOR OPTIONS:</p> <table> <tr> <td>-1.....\$1,247.00</td> <td>-13-2.....\$1,763.00</td> <td>-84.....\$775.00</td> </tr> <tr> <td>-2.....1,089.00</td> <td>-15.....402.00</td> <td>-92.....1,504.00</td> </tr> <tr> <td>-7.....436.00</td> <td>-TSI.....POA</td> <td>-T.....129.00</td> </tr> <tr> <td>-13.....228.00</td> <td>-VP.....245.00</td> <td>-X.....0.00</td> </tr> <tr> <td>-13-1.....2,056.00</td> <td>-70.....Ded. 512.00</td> <td></td> </tr> </table>	LIST PRICE		PIPE SIZE	39720	2" - 4"	\$3,341.00	-1.....\$1,247.00	-13-2.....\$1,763.00	-84.....\$775.00	-2.....1,089.00	-15.....402.00	-92.....1,504.00	-7.....436.00	-TSI.....POA	-T.....129.00	-13.....228.00	-VP.....245.00	-X.....0.00	-13-1.....2,056.00	-70.....Ded. 512.00		 <p>49320A</p>	<p align="center">12" SQUARE TOP, 6" DEEP</p> <table border="1"> <thead> <tr> <th colspan="5">LIST PRICE</th> </tr> </thead> <tbody> <tr> <td>PIPE SIZE</td> <td>49320A</td> <td>49320A-LF</td> <td>49320A-NB</td> <td>49320A-LF-NB</td> </tr> <tr> <td>2", 3", 4", 6"</td> <td align="center">\$4,139.00</td> <td align="center">\$3,503.00</td> <td align="center">\$5,387.00</td> <td align="center">\$4,751.00</td> </tr> </tbody> </table> <p>ADD FOR OPTIONS:</p> <table> <tr> <td>-3.....\$0.00</td> <td>-43.....561.00</td> </tr> <tr> <td>-4.....0.00</td> <td>-45.....Deduct 100.00</td> </tr> <tr> <td>-5.....1,802.00</td> <td>-55**.....312.00</td> </tr> <tr> <td>-7.....296.00</td> <td>-C.....310.00</td> </tr> <tr> <td>-8.....312.00</td> <td>-LF.....Deduct 636.00</td> </tr> <tr> <td>-15.....2,007.00</td> <td>-LG (ARE).....Deduct 374.00</td> </tr> <tr> <td>-16 (ARE).....627.00</td> <td>-LG (NB).....Deduct 815.00</td> </tr> <tr> <td>-16 (NB).....702.00</td> <td>-NB.....1,247.00</td> </tr> <tr> <td>-17 (ARE).....807.00</td> <td>-PFB.....260.00</td> </tr> <tr> <td>-17 (NB).....1,038.00</td> <td>-HG.....584.00</td> </tr> <tr> <td>-18 (ARE).....874.00</td> <td>-TS†.....POA</td> </tr> <tr> <td>-18 (NB).....1,457.00</td> <td>-VP (NB).....127.00</td> </tr> <tr> <td>-20 (NB).....373.00</td> <td>-X.....0.00</td> </tr> <tr> <td>-24 (NB).....356.00</td> <td>-Y (2" - 4").....0.00</td> </tr> <tr> <td>-31.....516.00</td> <td>-YGTC (2"-4").....41.00</td> </tr> <tr> <td>-33.....993.00</td> <td>-Z.....0.00</td> </tr> <tr> <td>-35*.....\$775.00</td> <td></td> </tr> </table> <p>*Specify -31 or -33 Bucket †Available up to 4" only **88450 Provided for 2" - 4" Body Primer Tapped for 6"</p>	LIST PRICE					PIPE SIZE	49320A	49320A-LF	49320A-NB	49320A-LF-NB	2", 3", 4", 6"	\$4,139.00	\$3,503.00	\$5,387.00	\$4,751.00	-3.....\$0.00	-43.....561.00	-4.....0.00	-45.....Deduct 100.00	-5.....1,802.00	-55**.....312.00	-7.....296.00	-C.....310.00	-8.....312.00	-LF.....Deduct 636.00	-15.....2,007.00	-LG (ARE).....Deduct 374.00	-16 (ARE).....627.00	-LG (NB).....Deduct 815.00	-16 (NB).....702.00	-NB.....1,247.00	-17 (ARE).....807.00	-PFB.....260.00	-17 (NB).....1,038.00	-HG.....584.00	-18 (ARE).....874.00	-TS†.....POA	-18 (NB).....1,457.00	-VP (NB).....127.00	-20 (NB).....373.00	-X.....0.00	-24 (NB).....356.00	-Y (2" - 4").....0.00	-31.....516.00	-YGTC (2"-4").....41.00	-33.....993.00	-Z.....0.00	-35*.....\$775.00																																										
LIST PRICE																																																																																																																		
PIPE SIZE	39720																																																																																																																	
2" - 4"	\$3,341.00																																																																																																																	
-1.....\$1,247.00	-13-2.....\$1,763.00	-84.....\$775.00																																																																																																																
-2.....1,089.00	-15.....402.00	-92.....1,504.00																																																																																																																
-7.....436.00	-TSI.....POA	-T.....129.00																																																																																																																
-13.....228.00	-VP.....245.00	-X.....0.00																																																																																																																
-13-1.....2,056.00	-70.....Ded. 512.00																																																																																																																	
LIST PRICE																																																																																																																		
PIPE SIZE	49320A	49320A-LF	49320A-NB	49320A-LF-NB																																																																																																														
2", 3", 4", 6"	\$4,139.00	\$3,503.00	\$5,387.00	\$4,751.00																																																																																																														
-3.....\$0.00	-43.....561.00																																																																																																																	
-4.....0.00	-45.....Deduct 100.00																																																																																																																	
-5.....1,802.00	-55**.....312.00																																																																																																																	
-7.....296.00	-C.....310.00																																																																																																																	
-8.....312.00	-LF.....Deduct 636.00																																																																																																																	
-15.....2,007.00	-LG (ARE).....Deduct 374.00																																																																																																																	
-16 (ARE).....627.00	-LG (NB).....Deduct 815.00																																																																																																																	
-16 (NB).....702.00	-NB.....1,247.00																																																																																																																	
-17 (ARE).....807.00	-PFB.....260.00																																																																																																																	
-17 (NB).....1,038.00	-HG.....584.00																																																																																																																	
-18 (ARE).....874.00	-TS†.....POA																																																																																																																	
-18 (NB).....1,457.00	-VP (NB).....127.00																																																																																																																	
-20 (NB).....373.00	-X.....0.00																																																																																																																	
-24 (NB).....356.00	-Y (2" - 4").....0.00																																																																																																																	
-31.....516.00	-YGTC (2"-4").....41.00																																																																																																																	
-33.....993.00	-Z.....0.00																																																																																																																	
-35*.....\$775.00																																																																																																																		
 <p>39960</p>	<p align="center">SQUARE TOP w/HINGED GRATE</p> <table border="1"> <thead> <tr> <th colspan="2">LIST PRICE</th> </tr> </thead> <tbody> <tr> <td>PIPE SIZE</td> <td align="center">39960</td> </tr> <tr> <td>2"</td> <td align="center">\$630.00</td> </tr> <tr> <td>3"</td> <td align="center">770.00</td> </tr> </tbody> </table> <p>ADD FOR OPTIONS:</p> <table> <tr> <td>-VP.....\$245.00</td> <td>-92.....\$539.00</td> </tr> <tr> <td>-ARE.....663.00</td> <td>-X.....0.00</td> </tr> <tr> <td>-TSI.....POA</td> <td></td> </tr> </table>	LIST PRICE		PIPE SIZE	39960	2"	\$630.00	3"	770.00	-VP.....\$245.00	-92.....\$539.00	-ARE.....663.00	-X.....0.00	-TSI.....POA																																																																																																				
LIST PRICE																																																																																																																		
PIPE SIZE	39960																																																																																																																	
2"	\$630.00																																																																																																																	
3"	770.00																																																																																																																	
-VP.....\$245.00	-92.....\$539.00																																																																																																																	
-ARE.....663.00	-X.....0.00																																																																																																																	
-TSI.....POA																																																																																																																		
<p>Floor Drain Option Descriptions</p> <table> <tr> <td>-ARE</td> <td>Acid Resisting Epoxy</td> </tr> <tr> <td>-C</td> <td>Bolted Flushing Clamp Device</td> </tr> <tr> <td>-TSI</td> <td>Trap Seal Insert</td> </tr> <tr> <td>-VP</td> <td>Secured Grate, Vandal-Proof Screws</td> </tr> <tr> <td>-1</td> <td>Satin Finish Nikaloy Top</td> </tr> <tr> <td>-2</td> <td>Satin Finish Bronze Top</td> </tr> <tr> <td>-7</td> <td>Ductile Iron Grate</td> </tr> <tr> <td>-13</td> <td>Dome Grate, Cast Iron</td> </tr> <tr> <td>-13-1</td> <td>Dome Grate, Nikaloy</td> </tr> <tr> <td>-13-2</td> <td>Dome Grate, Bronze</td> </tr> <tr> <td>-15</td> <td>Chained Grate</td> </tr> <tr> <td>-70</td> <td>Less Bucket</td> </tr> <tr> <td>-84</td> <td>Stainless Steel Mesh Bucket Liner</td> </tr> <tr> <td>-89</td> <td>Deck Clamp Assembly</td> </tr> <tr> <td>-92</td> <td>Galvanized Cast Iron Parts</td> </tr> </table> <p>Outlets</p> <table> <tr> <td>-66</td> <td>No-Hub Side Outlet</td> </tr> <tr> <td>-T</td> <td>Threaded Outlet</td> </tr> <tr> <td>-X</td> <td>Inside Caulk Outlet</td> </tr> <tr> <td>-Z</td> <td>No-Hub Outlet</td> </tr> </table>		-ARE	Acid Resisting Epoxy	-C	Bolted Flushing Clamp Device	-TSI	Trap Seal Insert	-VP	Secured Grate, Vandal-Proof Screws	-1	Satin Finish Nikaloy Top	-2	Satin Finish Bronze Top	-7	Ductile Iron Grate	-13	Dome Grate, Cast Iron	-13-1	Dome Grate, Nikaloy	-13-2	Dome Grate, Bronze	-15	Chained Grate	-70	Less Bucket	-84	Stainless Steel Mesh Bucket Liner	-89	Deck Clamp Assembly	-92	Galvanized Cast Iron Parts	-66	No-Hub Side Outlet	-T	Threaded Outlet	-X	Inside Caulk Outlet	-Z	No-Hub Outlet	<p align="center">Sanitary Floor Sink Option Descriptions</p> <table> <tr> <td>-C</td> <td>Clamp Device</td> <td>-31</td> <td>Sediment Bucket (Aluminum)</td> </tr> <tr> <td>-LF</td> <td>Less Flange</td> <td>-32</td> <td>Shallow Sediment Bucket (Alum.)</td> </tr> <tr> <td>-LG</td> <td>Less Grate</td> <td>-33</td> <td>Sediment Bucket (A.R. Finish)</td> </tr> <tr> <td>-HG</td> <td>Hinged Grate (-NB Only)</td> <td>-35</td> <td>Stainless Steel Mesh Bucket Liner</td> </tr> <tr> <td>-NB</td> <td>Nickel Bronze Traffic Top</td> <td>-43</td> <td>Internal Dome Strainer (A.R. Finish)</td> </tr> <tr> <td>-TSI</td> <td>Trap Seal Insert</td> <td>-45</td> <td>Less Internal Dome Strainer</td> </tr> <tr> <td>-VP</td> <td>Secured Grate, Vandal-Proof Screws</td> <td>-51</td> <td>Galvanized Cast Iron Inside and Outside</td> </tr> <tr> <td>-3</td> <td>1/2 Grate</td> <td>-52</td> <td>Painted Inside and Outside</td> </tr> <tr> <td>-4</td> <td>3/4 Grate</td> <td>-55</td> <td>1/2" Primer Tap or Adapter Outlets</td> </tr> <tr> <td>-5</td> <td>Nikaloy Extra Heavy-Duty Grate & Rim (Not SUPER-FLO® Design)</td> <td>-X</td> <td>Inside Caulk Outlet</td> </tr> <tr> <td>-7</td> <td>Full Grate w/ 2-1/2" Center Opening</td> <td>-Y</td> <td>Hub Outlet w/Gasket 2" - 4"</td> </tr> <tr> <td>-8</td> <td>Stainless Steel Depressed Grate</td> <td>-YGTC</td> <td>-Y Outlet Gasket with Test Cap</td> </tr> <tr> <td>-15</td> <td>Stainless Steel Rim and Grate</td> <td>-Z</td> <td>No-Hub Outlet</td> </tr> <tr> <td>-16</td> <td>Grate with 4" Round Funnel</td> <td></td> <td></td> </tr> <tr> <td>-17</td> <td>Grate with 6" Round Funnel</td> <td></td> <td></td> </tr> <tr> <td>-18</td> <td>Grate with 9" x 3-1/2" Oval Funnel</td> <td></td> <td></td> </tr> <tr> <td>-20</td> <td>Solid Nikaloy Cover</td> <td></td> <td></td> </tr> <tr> <td>-24</td> <td>Chained Grate</td> <td></td> <td></td> </tr> </table>			-C	Clamp Device	-31	Sediment Bucket (Aluminum)	-LF	Less Flange	-32	Shallow Sediment Bucket (Alum.)	-LG	Less Grate	-33	Sediment Bucket (A.R. Finish)	-HG	Hinged Grate (-NB Only)	-35	Stainless Steel Mesh Bucket Liner	-NB	Nickel Bronze Traffic Top	-43	Internal Dome Strainer (A.R. Finish)	-TSI	Trap Seal Insert	-45	Less Internal Dome Strainer	-VP	Secured Grate, Vandal-Proof Screws	-51	Galvanized Cast Iron Inside and Outside	-3	1/2 Grate	-52	Painted Inside and Outside	-4	3/4 Grate	-55	1/2" Primer Tap or Adapter Outlets	-5	Nikaloy Extra Heavy-Duty Grate & Rim (Not SUPER-FLO® Design)	-X	Inside Caulk Outlet	-7	Full Grate w/ 2-1/2" Center Opening	-Y	Hub Outlet w/Gasket 2" - 4"	-8	Stainless Steel Depressed Grate	-YGTC	-Y Outlet Gasket with Test Cap	-15	Stainless Steel Rim and Grate	-Z	No-Hub Outlet	-16	Grate with 4" Round Funnel			-17	Grate with 6" Round Funnel			-18	Grate with 9" x 3-1/2" Oval Funnel			-20	Solid Nikaloy Cover			-24	Chained Grate		
-ARE	Acid Resisting Epoxy																																																																																																																	
-C	Bolted Flushing Clamp Device																																																																																																																	
-TSI	Trap Seal Insert																																																																																																																	
-VP	Secured Grate, Vandal-Proof Screws																																																																																																																	
-1	Satin Finish Nikaloy Top																																																																																																																	
-2	Satin Finish Bronze Top																																																																																																																	
-7	Ductile Iron Grate																																																																																																																	
-13	Dome Grate, Cast Iron																																																																																																																	
-13-1	Dome Grate, Nikaloy																																																																																																																	
-13-2	Dome Grate, Bronze																																																																																																																	
-15	Chained Grate																																																																																																																	
-70	Less Bucket																																																																																																																	
-84	Stainless Steel Mesh Bucket Liner																																																																																																																	
-89	Deck Clamp Assembly																																																																																																																	
-92	Galvanized Cast Iron Parts																																																																																																																	
-66	No-Hub Side Outlet																																																																																																																	
-T	Threaded Outlet																																																																																																																	
-X	Inside Caulk Outlet																																																																																																																	
-Z	No-Hub Outlet																																																																																																																	
-C	Clamp Device	-31	Sediment Bucket (Aluminum)																																																																																																															
-LF	Less Flange	-32	Shallow Sediment Bucket (Alum.)																																																																																																															
-LG	Less Grate	-33	Sediment Bucket (A.R. Finish)																																																																																																															
-HG	Hinged Grate (-NB Only)	-35	Stainless Steel Mesh Bucket Liner																																																																																																															
-NB	Nickel Bronze Traffic Top	-43	Internal Dome Strainer (A.R. Finish)																																																																																																															
-TSI	Trap Seal Insert	-45	Less Internal Dome Strainer																																																																																																															
-VP	Secured Grate, Vandal-Proof Screws	-51	Galvanized Cast Iron Inside and Outside																																																																																																															
-3	1/2 Grate	-52	Painted Inside and Outside																																																																																																															
-4	3/4 Grate	-55	1/2" Primer Tap or Adapter Outlets																																																																																																															
-5	Nikaloy Extra Heavy-Duty Grate & Rim (Not SUPER-FLO® Design)	-X	Inside Caulk Outlet																																																																																																															
-7	Full Grate w/ 2-1/2" Center Opening	-Y	Hub Outlet w/Gasket 2" - 4"																																																																																																															
-8	Stainless Steel Depressed Grate	-YGTC	-Y Outlet Gasket with Test Cap																																																																																																															
-15	Stainless Steel Rim and Grate	-Z	No-Hub Outlet																																																																																																															
-16	Grate with 4" Round Funnel																																																																																																																	
-17	Grate with 6" Round Funnel																																																																																																																	
-18	Grate with 9" x 3-1/2" Oval Funnel																																																																																																																	
-20	Solid Nikaloy Cover																																																																																																																	
-24	Chained Grate																																																																																																																	

SANITARY FLOOR SINKS





A WATTS Brand

	12" SQUARE TOP, 8" DEEP			
	LIST PRICE			
PIPE SIZE	49340A	49340A -LF	49340A -NB	49340A -LF-NB
2"- 4"	\$4,316.00	\$3,679.00	\$5,563.00	\$4,925.00
ADD FOR OPTIONS:				
-3	\$0.00	-43	\$561.00	
-4	0.00	-45	Deduct 100.00	
-5	1,802.00	-55**	312.00	
-7	296.00	-C	310.00	
-8	312.00	-HG	584.00	
-15	2,007.00	-LF	Deduct 636.00	
-16 (ARE)	627.00	-LG (ARE)	Deduct 374.00	
-16 (NB)	702.00	-LG (NB)	Deduct 815.00	
-17 (ARE)	807.00	-NB	1,247.00	
-17 (NB)	1,038.00	-PFB	260.00	
-18 (ARE)	874.00	-TSI	POA	
-18 (NB)	1,457.00	-VP (NB)	127.00	
-20 (NB)	373.00	-X	0.00	
-24 (NB)	356.00	-Y	0.00	
-31	516.00	-YGTC (2"-4")	41.00	
-33	993.00	-Z	0.00	
-35*	\$775.00			
* Specify -31 or -33 Bucket **88450 Provided				





	49420				SUPER-FLO® 16" SQUARE TOP, 12" DEEP			
	LIST PRICE							
PIPE SIZE	49420	49420 -LF	49420 -NB	49420 -LF-NB				
3", 4", 6"	\$7,775.00	\$6,948.00	\$9,794.00	\$8,965.00				
ADD FOR OPTIONS:								
-3	\$0.00	-43	\$516.00					
-4	0.00	-45	Deduct 100.00					
-7	296.00	-55**	312.00					
-16 (ARE)	627.00	-C	930.00					
-16 (NB)	702.00	-LF	Deduct 830.00					
-17 (ARE)	807.00	-LG (ARE)	Deduct 622.00					
-17 (NB)	1,038.00	-LG (NB)	Deduct 1,721.00					
-18 (ARE)	874.00	-NB	2,017.00					
-18 (NB)	1,454.00	-TSI†	POA					
-31	1,376.00	-VP (NB)	127.00					
-33	3,870.00	-X	0.00					
-35*	1,556.00	-Z (4" & 6")	0.00					
* Specify -31 or -33 Bucket ** 88450 Provided for 3" & 4". Body Primer Tapped for 6" † Available up to 4" only								

	12" SQUARE TOP, 10" DEEP			
	LIST PRICE			
PIPE SIZE	49360A	49360A -LF	49360A -NB	49360A -LF-NB
2"- 4"	\$4,527.00	\$3,889.00	\$5,775.00	\$5,138.00
ADD FOR OPTIONS:				
-3	\$0.00	-35*	\$775.00	
-4	0.00	-43	561.00	
-5	1,802.00	-45	Deduct 100.00	
-7	296.00	-55**	312.00	
-8	312.00	-C	310.00	
-15	2,007.00	-HG	584.00	
-16 (ARE)	627.00	-LF	Deduct 637.00	
-16 (NB)	702.00	-LG (ARE)	Deduct 374.00	
-17 (ARE)	807.00	-LG (NB)	Deduct 815.00	
-17 (NB)	1,038.00	-NB	1,248.00	
-18 (ARE)	874.00	-PFB	260.00	
-18 (NB)	1,457.00	-TSI	POA	
-20 (NB)	373.00	-VP (NB)	127.00	
-24 (NB)	356.00	-X	0.00	
-31	516.00	-Y	0.00	
-32	516.00	-YGTC (2"-4")	41.00	
-33	993.00	-Z	0.00	
* Specify -31 or -33 Bucket **88450 Provided				

	49500				SUPER-FLO® 8" ROUND TOP, 3" DEEP			
	LIST PRICE							
PIPE SIZE	49500	49500 -LF	49500 -NB	49500 -LF-NB				
2"- 4"	\$2,584.00	\$2,111.00	\$2,990.00	\$2,518.00				
ADD FOR OPTIONS:								
-3	\$0.00	-43	\$516.00					
-4	0.00	-45	Deduct 100.00					
-7	296.00	-51	0.00					
-8	310.00	-52	Deduct 296.00					
-16 (ARE)	627.00	-55**	312.00					
-16 (NB)	702.00	-C	310.00					
-17 (ARE)	807.00	-LF	Deduct 474.00					
-17 (NB)	1,038.00	-LG (ARE)	Deduct 312.00					
-18 (ARE)	874.00	-LG (NB)	Deduct 342.00					
-18 (NB)	1,454.00	-NB	406.00					
-31	373.00	-TSI	POA					
-33	897.00	-X	0.00					
-35*	775.00	-VP (NB)	127.00					
* Specify -31 or -33 Bucket **88450 Provided								

	49400				SUPER-FLO® 16" SQUARE TOP, 6" DEEP			
	LIST PRICE							
PIPE SIZE	49400	49400 -LF	49400 -NB	49400 -LF-NB				
2", 4", 6"	\$7,775.00	\$7,162.00	\$9,794.00	\$9,179.00				
ADD FOR OPTIONS:								
-3	\$0.00	-43	\$517.00					
-4	0.00	-45	Deduct 100.00					
-7	296.00	-55**	312.00					
-16 (ARE)	627.00	-C	930.00					
-16 (NB)	702.00	-LF	Deduct 613.00					
-17 (ARE)	807.00	-LG (ARE)	Deduct 622.00					
-17 (NB)	1,038.00	-LG (NB)	Deduct 1,721.00					
-18 (ARE)	874.00	-NB	2,017.00					
-18 (NB)	1,454.00	-TSI†	POA					
-31	1,376.00	-VP (NB)	127.00					
-33	3,870.00	-X	0.00					
-35*	1,556.00	-Z (4" & 6")	0.00					
* Specify -31 or -33 Bucket ** 88450 Provided for 3" & 4". Body Primer Tapped for 6" † Available up to 4" only								

	49520A				SUPER-FLO® 8" ROUND TOP, 6" DEEP			
	LIST PRICE							
PIPE SIZE	49520A	49520A -LF	49520A -NB	49520A -LF-NB				
2"- 4"	\$2,663.00	\$2,187.00	\$3,415.00	\$2,940.00				
ADD FOR OPTIONS:								
-3	\$0.00	-45	Deduct \$100.00					
-4	0.00	-51	0.00					
-7	296.00	-52	Deduct 274.00					
-8	310.00	-55**	312.00					
-16 (ARE)	627.00	-C	310.00					
-16 (NB)	702.00	-LF	Deduct 476.00					
-17 (ARE)	807.00	-LG (ARE)	Deduct 312.00					
-17 (NB)	1,038.00	-LG (NB)	Deduct 342.00					
-18 (ARE)	874.00	-NB	752.00					
-18 (NB)	1,454.00	-TSI	POA					
-31	373.00	-VP (NB)	127.00					
-33	897.00	-X	0.00					
-35*	775.00	-Z	0.00					
-43	516.00							
* Specify -31 or -33 Bucket **88450 Provided								

 <p>49580A</p>	<p>SUPER-FLO® 12" ROUND TOP, 8" DEEP</p> <table border="1"> <thead> <tr> <th colspan="5">LIST PRICE</th> </tr> <tr> <th>PIPE SIZE</th> <th>49580A</th> <th>49580A -LF</th> <th>49580A -NB</th> <th>49580A -LF-NB</th> </tr> </thead> <tbody> <tr> <td>2"- 4"</td> <td>\$3,400.00</td> <td>\$2,780.00</td> <td>\$5,056.00</td> <td>\$4,434.00</td> </tr> </tbody> </table> <p>ADD FOR OPTIONS:</p> <table> <tbody> <tr> <td>-3</td> <td>\$0.00</td> <td>-45</td> <td>Deduct \$100.00</td> </tr> <tr> <td>-4</td> <td>0.00</td> <td>-51</td> <td>0.00</td> </tr> <tr> <td>-7</td> <td>296.00</td> <td>-52</td> <td>Deduct 475.00</td> </tr> <tr> <td>-8</td> <td>312.00</td> <td>-55**</td> <td>312.00</td> </tr> <tr> <td>-16 (ARE).....</td> <td>627.00</td> <td>-C.....</td> <td>310.00</td> </tr> <tr> <td>-16 (NB)</td> <td>702.00</td> <td>-LF</td> <td>Deduct 620.00</td> </tr> <tr> <td>-17 (ARE).....</td> <td>807.00</td> <td>-LG (ARE).....</td> <td>Deduct 434.00</td> </tr> <tr> <td>-17 (NB)</td> <td>1,038.00</td> <td>-LG (NB)</td> <td>Deduct 841.00</td> </tr> <tr> <td>-18 (ARE).....</td> <td>874.00</td> <td>-NB</td> <td>1,656.00</td> </tr> <tr> <td>-18 (NB)</td> <td>1,454.00</td> <td>-TSl</td> <td>POA</td> </tr> <tr> <td>-31</td> <td>516.00</td> <td>-VP (NB).....</td> <td>127.00</td> </tr> <tr> <td>-33</td> <td>897.00</td> <td>-X</td> <td>0.00</td> </tr> <tr> <td>-35*.....</td> <td>775.00</td> <td>-Z</td> <td>0.00</td> </tr> <tr> <td>-43</td> <td>516.00</td> <td></td> <td></td> </tr> </tbody> </table> <p>* Specify -31 or -33 Bucket</p> <p>** 88450 Provided</p>	LIST PRICE					PIPE SIZE	49580A	49580A -LF	49580A -NB	49580A -LF-NB	2"- 4"	\$3,400.00	\$2,780.00	\$5,056.00	\$4,434.00	-3	\$0.00	-45	Deduct \$100.00	-4	0.00	-51	0.00	-7	296.00	-52	Deduct 475.00	-8	312.00	-55**	312.00	-16 (ARE).....	627.00	-C.....	310.00	-16 (NB)	702.00	-LF	Deduct 620.00	-17 (ARE).....	807.00	-LG (ARE).....	Deduct 434.00	-17 (NB)	1,038.00	-LG (NB)	Deduct 841.00	-18 (ARE).....	874.00	-NB	1,656.00	-18 (NB)	1,454.00	-TSl	POA	-31	516.00	-VP (NB).....	127.00	-33	897.00	-X	0.00	-35*.....	775.00	-Z	0.00	-43	516.00			 <p>49850</p>	<p>12" ROUND FLUSHING RIM TOP</p> <table border="1"> <thead> <tr> <th colspan="2">LIST PRICE</th> </tr> <tr> <th>PIPE SIZE</th> <th>49850</th> </tr> </thead> <tbody> <tr> <td>2", 3"*</td> <td>\$4,322.00</td> </tr> <tr> <td>4", 6"</td> <td>4,322.00</td> </tr> </tbody> </table> <p>ADD FOR OPTIONS:</p> <table> <tbody> <tr> <td>-13</td> <td>\$163.00</td> <td>-C</td> <td>\$312.00</td> </tr> <tr> <td>-14</td> <td>476.00</td> <td>-TSl†</td> <td>POA</td> </tr> <tr> <td>-51</td> <td>0.00</td> <td>-VP</td> <td>0.00</td> </tr> <tr> <td>-98</td> <td>9,270.00</td> <td>-X</td> <td>0.00</td> </tr> <tr> <td></td> <td></td> <td>-Z (6")</td> <td>0.00</td> </tr> </tbody> </table> <p>*The 49852 and 49853 use a 49854 Body with a Reducing Coupling.</p> <p>†Available up to 4" only</p>	LIST PRICE		PIPE SIZE	49850	2", 3"*	\$4,322.00	4", 6"	4,322.00	-13	\$163.00	-C	\$312.00	-14	476.00	-TSl†	POA	-51	0.00	-VP	0.00	-98	9,270.00	-X	0.00			-Z (6")	0.00
LIST PRICE																																																																																																						
PIPE SIZE	49580A	49580A -LF	49580A -NB	49580A -LF-NB																																																																																																		
2"- 4"	\$3,400.00	\$2,780.00	\$5,056.00	\$4,434.00																																																																																																		
-3	\$0.00	-45	Deduct \$100.00																																																																																																			
-4	0.00	-51	0.00																																																																																																			
-7	296.00	-52	Deduct 475.00																																																																																																			
-8	312.00	-55**	312.00																																																																																																			
-16 (ARE).....	627.00	-C.....	310.00																																																																																																			
-16 (NB)	702.00	-LF	Deduct 620.00																																																																																																			
-17 (ARE).....	807.00	-LG (ARE).....	Deduct 434.00																																																																																																			
-17 (NB)	1,038.00	-LG (NB)	Deduct 841.00																																																																																																			
-18 (ARE).....	874.00	-NB	1,656.00																																																																																																			
-18 (NB)	1,454.00	-TSl	POA																																																																																																			
-31	516.00	-VP (NB).....	127.00																																																																																																			
-33	897.00	-X	0.00																																																																																																			
-35*.....	775.00	-Z	0.00																																																																																																			
-43	516.00																																																																																																					
LIST PRICE																																																																																																						
PIPE SIZE	49850																																																																																																					
2", 3"*	\$4,322.00																																																																																																					
4", 6"	4,322.00																																																																																																					
-13	\$163.00	-C	\$312.00																																																																																																			
-14	476.00	-TSl†	POA																																																																																																			
-51	0.00	-VP	0.00																																																																																																			
-98	9,270.00	-X	0.00																																																																																																			
		-Z (6")	0.00																																																																																																			
 <p>49700</p>	<p>4" x 8" RECTANGULAR TOP, 4" DEEP</p> <table border="1"> <thead> <tr> <th colspan="5">LIST PRICE</th> </tr> <tr> <th>PIPE SIZE</th> <th>49700</th> <th>49700 -LF</th> <th>49700 -NB</th> <th>49700 -LF-NB</th> </tr> </thead> <tbody> <tr> <td>2", 3"</td> <td>\$3,012.00</td> <td>\$2,700.00</td> <td>\$3,554.00</td> <td>\$3,240.00</td> </tr> </tbody> </table> <p>ADD FOR OPTIONS:</p> <table> <tbody> <tr> <td>-3</td> <td>\$0.00</td> <td>-52</td> <td>Deduct \$274.00</td> </tr> <tr> <td>-4</td> <td>0.00</td> <td>-55*</td> <td>312.00</td> </tr> <tr> <td>-7</td> <td>296.00</td> <td>-C.....</td> <td>310.00</td> </tr> <tr> <td>-8</td> <td>312.00</td> <td>-LF</td> <td>Deduct 312.00</td> </tr> <tr> <td>-16 (ARE).....</td> <td>627.00</td> <td>-LG (ARE).....</td> <td>Deduct 246.00</td> </tr> <tr> <td>-16 (NB)</td> <td>702.00</td> <td>-LG (NB).....</td> <td>Deduct 499.00</td> </tr> <tr> <td>-30</td> <td>775.00</td> <td>-NB</td> <td>542.00</td> </tr> <tr> <td>-43</td> <td>516.00</td> <td>-TSl</td> <td>POA</td> </tr> <tr> <td>-45</td> <td>Deduct 100.00</td> <td>-VP (NB).....</td> <td>127.00</td> </tr> <tr> <td>-51</td> <td>0.00</td> <td>-X</td> <td>0.00</td> </tr> </tbody> </table> <p>* 88450 Provided</p>	LIST PRICE					PIPE SIZE	49700	49700 -LF	49700 -NB	49700 -LF-NB	2", 3"	\$3,012.00	\$2,700.00	\$3,554.00	\$3,240.00	-3	\$0.00	-52	Deduct \$274.00	-4	0.00	-55*	312.00	-7	296.00	-C.....	310.00	-8	312.00	-LF	Deduct 312.00	-16 (ARE).....	627.00	-LG (ARE).....	Deduct 246.00	-16 (NB)	702.00	-LG (NB).....	Deduct 499.00	-30	775.00	-NB	542.00	-43	516.00	-TSl	POA	-45	Deduct 100.00	-VP (NB).....	127.00	-51	0.00	-X	0.00	 <p>49870A</p>	<p>12" SQUARE CAN WASH DRAIN</p> <table border="1"> <thead> <tr> <th colspan="2">LIST PRICE</th> </tr> <tr> <th>PIPE SIZE</th> <th>49870A</th> </tr> </thead> <tbody> <tr> <td>3", 4"</td> <td>\$8,403.00</td> </tr> </tbody> </table> <p>ADD FOR OPTIONS:</p> <table> <tbody> <tr> <td>-35</td> <td>\$484.00</td> <td>-C</td> <td>\$310.00</td> </tr> <tr> <td>-51</td> <td>0.00</td> <td>-TSl</td> <td>POA</td> </tr> <tr> <td>-55*.....</td> <td>312.00</td> <td>-VP</td> <td>127.00</td> </tr> <tr> <td>-98</td> <td>9,270.00</td> <td>-X</td> <td>0.00</td> </tr> <tr> <td></td> <td></td> <td>-Z</td> <td>0.00</td> </tr> </tbody> </table> <p>* 88450 Provided</p>	LIST PRICE		PIPE SIZE	49870A	3", 4"	\$8,403.00	-35	\$484.00	-C	\$310.00	-51	0.00	-TSl	POA	-55*.....	312.00	-VP	127.00	-98	9,270.00	-X	0.00			-Z	0.00																		
LIST PRICE																																																																																																						
PIPE SIZE	49700	49700 -LF	49700 -NB	49700 -LF-NB																																																																																																		
2", 3"	\$3,012.00	\$2,700.00	\$3,554.00	\$3,240.00																																																																																																		
-3	\$0.00	-52	Deduct \$274.00																																																																																																			
-4	0.00	-55*	312.00																																																																																																			
-7	296.00	-C.....	310.00																																																																																																			
-8	312.00	-LF	Deduct 312.00																																																																																																			
-16 (ARE).....	627.00	-LG (ARE).....	Deduct 246.00																																																																																																			
-16 (NB)	702.00	-LG (NB).....	Deduct 499.00																																																																																																			
-30	775.00	-NB	542.00																																																																																																			
-43	516.00	-TSl	POA																																																																																																			
-45	Deduct 100.00	-VP (NB).....	127.00																																																																																																			
-51	0.00	-X	0.00																																																																																																			
LIST PRICE																																																																																																						
PIPE SIZE	49870A																																																																																																					
3", 4"	\$8,403.00																																																																																																					
-35	\$484.00	-C	\$310.00																																																																																																			
-51	0.00	-TSl	POA																																																																																																			
-55*.....	312.00	-VP	127.00																																																																																																			
-98	9,270.00	-X	0.00																																																																																																			
		-Z	0.00																																																																																																			
 <p>49720</p>	<p>6" x 12" RECTANGULAR TOP, 7" DEEP</p> <table border="1"> <thead> <tr> <th colspan="5">LIST PRICE</th> </tr> <tr> <th>PIPE SIZE</th> <th>49720</th> <th>49720 -LF</th> <th>49720 -NB</th> <th>49720 -LF-NB</th> </tr> </thead> <tbody> <tr> <td>3", 4", 6"</td> <td>\$4,009.00</td> <td>\$3,554.00</td> <td>\$4,816.00</td> <td>\$4,359.00</td> </tr> </tbody> </table> <p>ADD FOR OPTIONS:</p> <table> <tbody> <tr> <td>-LF</td> <td>Deduct \$457.00</td> <td>-16 (NB)</td> <td>\$702.00</td> </tr> <tr> <td>-NB.....</td> <td>807.00</td> <td>-18 (ARE).....</td> <td>874.00</td> </tr> <tr> <td>-LG (ARE).....</td> <td>Deduct 312.00</td> <td>-18 (NB)</td> <td>1,450.00</td> </tr> <tr> <td>-LG (NB)</td> <td>Deduct 561.00</td> <td>-30</td> <td>775.00</td> </tr> <tr> <td>-3</td> <td>0.00</td> <td>-43</td> <td>516.00</td> </tr> <tr> <td>-4</td> <td>0.00</td> <td>-45</td> <td>Deduct 100.00</td> </tr> <tr> <td>-7</td> <td>296.00</td> <td>-51</td> <td>0.00</td> </tr> <tr> <td>-8</td> <td>312.00</td> <td>-52</td> <td>Deduct 475.00</td> </tr> <tr> <td>-TSl†</td> <td>POA</td> <td>-55*</td> <td>312.00</td> </tr> <tr> <td>-VP (NB).....</td> <td>127.00</td> <td>-C.....</td> <td>310.00</td> </tr> <tr> <td>-16 (ARE).....</td> <td>627.00</td> <td>-X</td> <td>0.00</td> </tr> </tbody> </table> <p>* 88450 Provided 3" & 4". Body Primer Tapped for 6".</p> <p>† Available up to 4" only</p>	LIST PRICE					PIPE SIZE	49720	49720 -LF	49720 -NB	49720 -LF-NB	3", 4", 6"	\$4,009.00	\$3,554.00	\$4,816.00	\$4,359.00	-LF	Deduct \$457.00	-16 (NB)	\$702.00	-NB.....	807.00	-18 (ARE).....	874.00	-LG (ARE).....	Deduct 312.00	-18 (NB)	1,450.00	-LG (NB)	Deduct 561.00	-30	775.00	-3	0.00	-43	516.00	-4	0.00	-45	Deduct 100.00	-7	296.00	-51	0.00	-8	312.00	-52	Deduct 475.00	-TSl†	POA	-55*	312.00	-VP (NB).....	127.00	-C.....	310.00	-16 (ARE).....	627.00	-X	0.00	<p>Option Descriptions</p> <ul style="list-style-type: none"> -C Clamp Device -LF Less Flange -LG Less Grate -NB Nickel Bronze Traffic Top -TSl Trap Seal Insert -VP Secured Grate, Vandal-Proof Screws -3 1/2 Grate -4 3/4 Grate -7 Full Grate with 2-1/2" Center Opening -8 Stainless Steel Depressed Grate -13 One-Piece Satin Nikaloy Grate -14 Loose-Set Satin Nikaloy Grate -16 Grate with 4" Round Funnel -17 Grate with 6" Round Funnel -18 Grate with 9" x 3-1/2" Oval Funnel -30 Stainless Steel Sediment Bucket -31 Sediment Bucket (Aluminum) -33 Sediment Bucket (A.R. Finish) -35 Stainless Steel Mesh Bucket Liner -43 Internal Dome Strainer (A.R. Finish) -45 Less Internal Dome Strainer -51 Galvanized Cast Iron Inside and Outside -52 Painted Inside and Outside -55 1/2" Primer Tap or Adapter -98 Water Supply Control Box <p>Outlets</p> <ul style="list-style-type: none"> -X Inside Caulk Outlet -Z No-Hub Outlet 																																									
LIST PRICE																																																																																																						
PIPE SIZE	49720	49720 -LF	49720 -NB	49720 -LF-NB																																																																																																		
3", 4", 6"	\$4,009.00	\$3,554.00	\$4,816.00	\$4,359.00																																																																																																		
-LF	Deduct \$457.00	-16 (NB)	\$702.00																																																																																																			
-NB.....	807.00	-18 (ARE).....	874.00																																																																																																			
-LG (ARE).....	Deduct 312.00	-18 (NB)	1,450.00																																																																																																			
-LG (NB)	Deduct 561.00	-30	775.00																																																																																																			
-3	0.00	-43	516.00																																																																																																			
-4	0.00	-45	Deduct 100.00																																																																																																			
-7	296.00	-51	0.00																																																																																																			
-8	312.00	-52	Deduct 475.00																																																																																																			
-TSl†	POA	-55*	312.00																																																																																																			
-VP (NB).....	127.00	-C.....	310.00																																																																																																			
-16 (ARE).....	627.00	-X	0.00																																																																																																			

SS RETROFIT LINERS FOR SANITARY FLOOR SINKS



A WATTS Brand











STAINLESS STEEL RETROFIT LINER				
NOM. PIPE SIZE	TOP SIZE	GRATE TYPE	BODY DEPTH	LIST PRICE
2"	8"	Reinforced Perforated	6"	POA
3"	8"	Reinforced Perforated	6"	POA
4"	8"	Reinforced Perforated	6"	POA
2"	12"	Reinforced Perforated	6"	POA
3"	12"	Reinforced Perforated	6"	POA
4"	12"	Reinforced Perforated	6"	POA
2"	12"	Reinforced Perforated	8"	POA
3"	12"	Reinforced Perforated	8"	POA
4"	12"	Reinforced Perforated	8"	POA
2"	12"	Reinforced Perforated	10"	POA
3"	12"	Reinforced Perforated	10"	POA
4"	12"	Reinforced Perforated	10"	POA
2"	16"	Reinforced Perforated	6"	POA
3"	16"	Reinforced Perforated	6"	POA
4"	16"	Reinforced Perforated	6"	POA
6"	16"	Reinforced Perforated	6"	POA
8"	16"	Reinforced Perforated	6"	POA
2"	16"	Reinforced Perforated	12"	POA
3"	16"	Reinforced Perforated	12"	POA
4"	16"	Reinforced Perforated	12"	POA
6"	16"	Reinforced Perforated	12"	POA
8"	16"	Reinforced Perforated	12"	POA

ADD FOR OPTIONS:

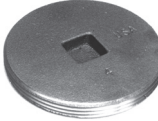
DESCRIPTION	LIST ADD	LIST ADD	LIST ADD	LIST ADD	LIST ADD	LIST ADD
BENT EDGE	POA	POA	POA	POA	POA	POA
BENT EDGE - for 4" Pipe Size	N/A	N/A	N/A	POA	N/A	N/A
BENT EDGE - for 6" Pipe Size	N/A	N/A	N/A	N/A	POA	POA
3/4 GRATE	N/C	N/C	N/C	N/C	N/C	N/C
1/2 GRATE	N/C	N/C	N/C	N/C	N/C	N/C
No Grate	(POA)	(POA)	(POA)	(POA)	(POA)	(POA)
Anti-Slip Mesh Grate	N/A	POA	POA	POA	POA	POA
Perimeter Slot Plate Grate	POA	POA	POA	POA	POA	POA
Ladder Grate	POA	POA	POA	POA	POA	POA
Filter Basket	POA	POA	POA	POA	POA	POA
Solid Bucket	POA	POA	POA	POA	POA	POA
Secured Grate	POA	POA	POA	POA	POA	POA
316L Stainless Steel	PLUS 20%	PLUS 20%	PLUS 20%	PLUS 20%	PLUS 20%	PLUS 20%

For part numbers and pricing on Josam's Stainless Steel Retrofit Liners please refer to the Stainless Steel Drains Price Guide.

	LEVELEZE® KLEENATRON® II SPECIAL-DUTY													
	LIST PRICE													
	PIPE SIZE	55000	55000-1 55000-2	55000-1-12 55000-2-12	55000-1-SQ 55000-2-SQ	55000-SS 55000-SS-SQ	55000-1-SD 55000-2-SD	55000-1-13 55000-2-13						
	2"	\$846.00	\$1,041.00	\$1,041.00	\$1,041.00	\$1,800.00	\$1,293.00	\$1,559.00						
	3"	967.00	1,096.00	1,096.00	1,096.00	1,857.00	1,356.00	1,679.00						
	4"	1,146.00	1,466.00	1,466.00	1,466.00	2,224.00	1,720.00	2,053.00						
	5" (Z)	2,006.00	2,386.00	2,386.00	2,386.00	3,148.00	2,646.00	3,032.00						
	6" (Z)	2,006.00	2,386.00	2,386.00	2,386.00	3,148.00	2,646.00	3,032.00						
	ADD FOR OPTIONS:													
	-1.....	ABOVE	-14.....	\$129.00	-PFB.....	\$272.00								
-1-12.....	ABOVE	-22 (2"- 4").....	315.00	-SS.....	ABOVE									
-1-13.....	ABOVE	-22 (5"- 6").....	1,013.00	-SS-SD**.....	898.00									
-1-SD.....	ABOVE	-31.....	362.00	-SS-SQ.....	ABOVE									
-1-SQ.....	ABOVE	-41.....	176.00	-WF*.....	778.00									
-2.....	ABOVE	-ARE.....	584.00	-X.....	0.00									
-2-12.....	ABOVE	-CFC.....	475.00	-Y.....	0.00									
-2-13.....	ABOVE	-DBCL (4"X, 6"Z).....	103.00	-YGTC (2"-4").....	41.00									
-2-SD.....	ABOVE	-DBCS.....	101.00	-Z.....	0.00									
-2-SQ.....	ABOVE	-F.....	159.00	-VP.....	159.00									
-5.....	507.00	-GC.....	505.00											
<p>*Not Available on Cast Iron **When choosing option -SS-SD, the price should be added to the 55000-SS List Price shown above.</p>														
	SPANNER TYPE FLOOR CLEANOUT						FLOOR CLEANOUT							
	LIST PRICE						LIST PRICE							
	PIPE SIZE	2"	3"	4"	5"		6"	PIPE SIZE	2", 3"	4"				
		\$815.00	\$1,129.00	1,254.00	\$1,971.00		\$2,157.00		\$1,625.00	\$1,684.00				
ADD FOR OPTIONS:														
-2..... Deduct \$127.00			-24..... \$246.00			-1..... \$663.00			-20..... \$0.00					
-14..... 129.00			-ARE..... 584.00			-2..... 572.00			-31..... 737.00					
			-X..... 0.00			-6..... 533.00			-ARE..... 584.00					
						-6-1..... 1,197.00			-AE..... 393.00					
						-6-2..... 1,106.00			-VP..... 246.00					
						-12..... 589.00			-X..... 0.00					
						-14..... 129.00								
	LEVELEZE® KLEENATRON® SPECIAL-DUTY CAST IRON TOP 57008-Z-CI Standard							THREADED BRONZE PLUG						
	LIST PRICE							LIST PRICE						
	PIPE SIZE	8"			\$2,336.00			PIPE SIZE	1"	1-1/4"	1-1/2"	2"	2-1/2"	3"
									69.00	69.00	69.00	90.00	112.00	154.00
ADD FOR OPTIONS:														
-1..... \$382.00			-14..... \$129.00			-1-1/2"			3"			154.00		
-1-12..... 389.00			-31..... 356.00			-2"			8"			1,750.00		
-1-SD..... 644.00			-ARE..... 584.00			-2-1/2"			*10"					
-1-SQ..... 382.00			-CFC..... 475.00			-3"								
-2..... 287.00			-DBC..... 177.00			-4"								
-2-12..... 287.00			-LT..... Deduct 1,042.00			-5"								
-2-SD..... 550.00			-VP..... 154.00			-6"								
-2-SQ..... 287.00			-Z..... STD			-7"								
<p>*For 10" Size, Specify 58549-20. 10" Size Available with Raised Head Plug Only</p>														
	DEBRIS COVER													
	LIST PRICE													
	SERIES	COVER	ADD FOR OPTION:											
	55000	-DBCS	\$103.00											
55004-X	-DBCL	103.00												
55006-Z	-DBCL	103.00												
57008	-DBC	177.00												
	ADJUSTABLE FLOOR CLEANOUT						ACCESS HOUSING AND COVER							
	LIST PRICE						LIST PRICE							
	PIPE SIZE	2"	3"	4"	5"		6"	PIPE SIZE	58580	58580-1 58580-1-SQ	58580-2	58580-5		
		\$821.00	\$942.00	\$1,076.00	1,213.00		1,237.00		2"	\$501.00	\$689.00	\$626.00	\$1,001.00	
ADD FOR OPTIONS:														
-2..... Deduct \$61.00			-VP..... \$154.00			-1 (2")..... \$188.00			-5..... \$501.00					
-31..... 148.00			-Y..... 0.00			-1 (3", 4")..... 274.00			-14..... 129.00					
-14..... 129.00			-YGTC (2"-4")..... 41.00			-1 (5", 6")..... 309.00			-SD..... 261.00					
-ARE..... 584.00			-Z..... 0.00			-2 (2")..... 127.00			-SQ (2")..... 188.00					
						-2 (3", 4")..... 188.00			-SQ (3", 4")..... 274.00					
						-2 (5", 6")..... 243.00			-SQ (5", 6")..... 309.00					

58600 WALL ACCESS COVER

LIST PRICE			
TYPE NO.	58604	58606	58608
	\$231.00	\$288.00	\$783.00

ADD FOR OPTIONS:

-17 \$30.00	-COT6..... \$2,079.00
-20* 0.00	-PLG1-1/2 69.00
-31** 261.00	-PLG2 90.00
-CO2 154.00	-PLG2-1/2 112.00
-CO3 246.00	-PLG3 154.00
-CO4 341.00	-PLG3-1/2 257.00
-CO6 696.00	-PLG4 288.00
-COT2 374.00	-PLG5 428.00
-COT3 468.00	-PLG6 589.00
-COT4 736.00	-VP 113.00

*Specify -PLG, -CO or -COT.
**Specify -CO or -COT.

58640 WALL ACCESS COVER

LIST PRICE			
TYPE NO.	58642	58644	58646
	\$996.00	\$1,466.00	\$1,580.00

ADD FOR OPTIONS:

-2 (58642)Deduct 131.00	-CO3..... \$246.00
-2 (58644)Deduct 192.00	-CO4..... 341.00
-2 (58646)Deduct 208.00	-CO6..... 696.00
-10 0.00	-COT2..... 374.00
-2-10 0.00	-COT3..... 468.00
-20* 0.00	-COT4..... 736.00
-31* 261.00	-COT6..... 2,079.00
-CO2 154.00	-VP 154.00

*Specify -CO or -COT.

58610 WALL OR FLOOR ACCESS COVER

LIST PRICE			
TYPE NO.	58614	58616	58618
	\$589.00	\$1,012.00	\$1,457.00

ADD FOR OPTIONS:

-2 (58614)Deduct \$58.00	-CO3..... \$246.00
-2 (58616)Deduct 181.00	-CO4..... 341.00
-2 (58618)Deduct 181.00	-CO6..... 696.00
-10 0.00	-COT2..... 374.00
-14 129.00	-COT3..... 468.00
-20* 0.00	-COT4 736.00
-31* 261.00	-COT6 2,079.00
-CO2 154.00	-VP 154.00

*Specify -CO or -COT.

58620 WALL OR FLOOR ACCESS COVER

LIST PRICE		
TYPE NO.	58624	58626
	\$1,358.00	\$1,763.00

ADD FOR OPTIONS:

-2 (58624)Deduct \$92.00	-CO3..... \$246.00
-2 (58626)Deduct 192.00	-CO4..... 341.00
-10 0.00	-CO6..... 696.00
-14 129.00	-COT2..... 374.00
-20* 0.00	-COT3..... 468.00
-31* 261.00	-COT4 736.00
-VP 154.00	-COT6 2,079.00
-CO2 154.00	

*Specify -CO or -COT.

58630 WALL OR FLOOR ACCESS COVER

LIST PRICE		
TYPE NO.	58631	58632
	\$1,315.00	\$1,937.00

ADD FOR OPTIONS:

-2 (58631)Deduct 127.00	-CO6..... \$696.00
-2 (58632)Deduct 208.00	-COT2..... 374.00
-20* 0.00	-COT3..... 468.00
-31* 261.00	-COT4 736.00
-CO2 154.00	-COT6 2,079.00
-CO3 246.00	-VP 154.00
-CO4 341.00	

*Specify -CO or -COT.

- ### Option Descriptions
- AE Adjustable Extension
 - ARE Acid-Resisting Epoxy
 - CFC Carpet Cleanout Flange Cover
 - CO2 No-Hub Cleanout, 2"
 - CO3 No-Hub Cleanout, 3"
 - CO4 No-Hub Cleanout, 4"
 - CO6 No-Hub Cleanout, 6"
 - COT2 No-Hub Cleanout Tee, 2"
 - COT3 No-Hub Cleanout Tee, 3"
 - COT4 No-Hub Cleanout Tee, 4"
 - COT6 No-Hub Cleanout Tee, 6"
 - DBC Debris Cover
 - DBCS Debris Cover Small
 - DBCL Debris Cover Large
 - F Flange Only
 - GC Gasket Cover
 - LT Less Top
 - PLG Bronze N.P.T. Plug (Specify Plug Size)
 - SS Stainless Steel Top
 - SS-SD Stainless Steel, Special Duty Top
 - SS-SQ Square Top, Stainless Steel
 - VP Secured Cover, Vandal-Proof Screws
 - WF Wide Flange (not available on Cl)
 - 1 Satin Finish Nikaloy Top
 - 1-SD Special Duty Satin Finish Nikaloy Top
 - 1-SQ Square Top, Satin Finish Nikaloy
 - 1-12 Cover Recessed for Tile, Satin Finish Nikaloy
 - 1-13 Terrazzo Tile Cover, Satin Finish Nikaloy
 - 2 Satin Finish Bronze Top
 - 2-SD Special Duty Satin Finish Bronze Top
 - 2-SQ Square Top, Satin Finish Bronze
 - 2-10 Satin Finish Bronze Scoriated Cover
 - 2-12 Cover Recessed for Tile, Satin Finish Bronze
 - 2-13 Terrazzo Tile Cover, Satin Finish Bronze
 - 5 Ductile Iron Top
 - 6 Square Top, Cast Iron
 - 6-1 Square Top, Nikaloy
 - 6-2 Square Top, Bronze
 - 10 Scoriated Cover
 - 11 Smooth Top
 - 12 Cover Recessed for Tile
 - 14 Carpet Cleanout Marker
 - 19 Plug Tapped for Center Screw
 - 20 Raised Head Bronze Plug
 - 22 Taper Thread Bronze Plug
 - 24 Spanner Wrench
 - 31 Galvanized Cast Iron Parts
 - 41 Clamp Ring and Flange
- Outlets**
- X Inside Caulk Outlet
 - Y Hub Outlet w/Gasket 2" - 4"
 - Z No-Hub Outlet

	58650 STAINLESS STEEL WALL ACCESS COVER		
	LIST PRICE		
TYPE NO.	58656	\$1,466.00	
ADD FOR OPTIONS:			
-20*	\$0.00	-COT2	\$374.00
-31*	263.00	-COT3	468.00
-CO2	154.00	-COT4	736.00
-CO3	246.00	-COT6	2,079.00
-CO4	341.00	-VP	154.00
-CO6	696.00		
*Specify -CO or -COT.			

	58680 ACCESS COVER		
	LIST PRICE		
TYPE NO.	58680	\$2,303.00	
ADD FOR OPTIONS:			
-1	\$1,015.00	-ARE	\$584.00
-2	905.00	-CO2	154.00
-5	764.00	-CO3	246.00
-20*	0.00	-CO4	341.00
-26	276.00	-CO6	696.00
-31	924.00	-VP	154.00
Special Wording on Cover, SAN. or STORM. Specify on Order\$245.00			
*Specify -CO or -COT.			

	58900 NO-HUB CLEANOUT FERRULE			
	LIST PRICE			
PIPE SIZE	2"	3"	4"	6"
	\$154.00	\$246.00	\$341.00	\$696.00
ADD FOR OPTIONS:				
-19	\$76.00	-31	\$261.00	
-20	0.00	-Z	0.00	

	58910 NO-HUB CLEANOUT TEE w/PLUG			
	LIST PRICE			
PIPE SIZE	2"	3"	4"	6"
	\$374.00	\$468.00	\$736.00	\$2,079.00
ADD FOR OPTIONS:				
-19	\$76.00	-31	\$261.00	
-20	0.00	-Z	0.00	

Cleanout Option Descriptions

- ARE Acid-Resisting Epoxy
- CO2 No-Hub Cleanout, 2"
- CO3 No-Hub Cleanout, 3"
- CO4 No-Hub Cleanout, 4"
- CO6 No-Hub Cleanout, 6"
- COT2 No-Hub Cleanout Tee, 2"
- COT3 No-Hub Cleanout Tee, 3"
- COT4 No-Hub Cleanout Tee, 4"
- COT6 No-Hub Cleanout Tee, 6"
- PLG1-1/2 Bronze NPT Plug, 1-1/2"
- PLG2 Bronze NPT Plug, 2"
- PLG2-1/2 Bronze NPT Plug, 2-1/2"
- PLG3 Bronze NPT Plug, 3"
- PLG3-1/2 Bronze NPT Plug, 3-1/2"
- PLG4 Bronze NPT Plug, 4"
- PLG5 Bronze NPT Plug, 5"
- PLG6 Bronze NPT Plug, 6"
- SD Special-Duty Top, Nikaloy
- SQ Square Top
- VP Secured Cover, Vandal-Proof Screws
- 1 Satin Finish Nikaloy Top
- 2 Satin Finish Bronze Top
- 5 Ductile Iron Top
- 10 Scoriated Cover
- 14 Carpet Cleanout Marker
- 17 Center Screw Longer than Standard
- 19 Plug Tapped for Center Screw
- 20 Raised Head Bronze Plug
- 26 Gasketed Cover
- 31 Galvanized Cast Iron Parts

- Outlets
- Z No-Hub Outlet

GREASE INTERCEPTORS



A WATTS Brand

60100H	MANUAL CLEANING, ON-FLOOR TYPE													
	TYPE NO.	PIPE SIZE	FLOW RATE GPM	GR. CAP. LBS	LIST PRICE	FOR OPTIONS, ADD TO LIST PRICE								
						-40	-61	-ISI	-EXT 6"	Ea. Add'l Inch Ext.	-RT	-ET	-HD	-AC
60102H	2	7	14	\$5,786.00	N/A	N/A	\$3,277.00	N/A	N/A	N/A	12,181.00	\$14,046.00	\$10,206.00	\$2,259.00
60103H	2	10	20	6,799.00	\$9,406.00	3,154.00	3,277.00	8,432.00	420.00	12,668.00	14,714.00	10,976.00	2,259.00	
60104H	2	15	30	10,063.00	11,410.00	3,154.00	3,277.00	8,551.00	474.00	13,590.00	16,029.00	11,802.00	2,259.00	
60105H	3	20	40	12,323.00	12,763.00	3,154.00	3,277.00	8,551.00	536.00	14,462.00	17,280.00	12,501.00	3,164.00	
60106H	3	25	50	13,844.00	14,750.00	3,522.00	3,363.00	8,551.00	601.00	14,769.00	17,865.00	13,188.00	3,164.00	
60107H	3	35	70	17,110.00	18,107.00	3,660.00	3,806.00	10,357.00	665.00	14,769.00	19,473.00	14,576.00	3,164.00	
60108H	3	50	100	22,659.00	25,176.00	4,156.00	5,686.00	11,202.00	775.00	16,370.00	20,505.00	15,275.00	3,164.00	
60109H	3	75	150	46,571.00	POA	6,596.00	6,130.00	11,641.00	852.00	20,339.00	22,256.00	16,296.00	4,430.00	
60110H	4	100	200	52,388.00	POA	7,373.00	6,713.00	13,193.00	971.00	32,339.00	34,257.00	21,733.00	4,430.00	

ADD FOR OPTIONS:

-40 ABOVE -ET ABOVE -RT ABOVE

-61 ABOVE -EXT ABOVE -SS POA•

-85 \$252.00 -HD ABOVE

-AC ABOVE -ISI ABOVE

• PRICE ON APPLICATION

60100-SA	SEMI-AUTOMATIC						
	TYPE NO.	PIPE SIZE	FLOW RATE GPM	GREASE CAP. LBS	LIST PRICE	FOR OPTIONS, ADD TO LIST PRICE	
						-RT	-ET
60102-SA	2	7	14	\$14,860.00	\$11,918.00	\$14,600.00	
60103-SA	2	10	20	17,530.00	13,845.00	16,588.00	
60104-SA	2	15	30	18,678.00	15,379.00	18,446.00	
60105-SA	2	20	40	22,954.00	15,635.00	19,093.00	
60106-SA	3*	25	50	27,843.00	15,926.00	19,841.00	
60107-SA	3*	35	70	28,575.00	17,023.00	21,282.00	
60108-SA	3*	50	100	32,617.00	17,178.00	22,007.00	
60109-SA	3*	75	150	37,661.00	22,365.00	23,753.00	

ADD FOR OPTIONS:

-62 \$0.00 -66 \$512.00 -85 \$252.00



-65 366.00 -67 728.00 -ET ABOVE

-RT ABOVE

*3" Sizes Normally Furnished with 4" x 3" Reducing Bushings.

Grease Interceptor Option Descriptions

- | | |
|--|---|
| -ET Enclosed Type | -40 Cover Recess for Floor Finish |
| -EXT Extension, 6" Standard, Specify Extension Height | -61 Flange and Clamp Device |
| -AC Aluminum Cover | -62 4" Inlet and Outlet Available on Standard 3" Sizes |
| -HD Heavy-Duty Cover | -65 Hub Inlet, Spigot Outlet, 2 |
| -ISI Integrated Solids Interceptor | -66 Hub Inlet, Spigot Outlet, 3 |
| -RT Recessed Type | -67 Hub Inlet, Spigot Outlet, 4" |
| -SS Stainless Steel | -85 Enzymatic Port |

60110A 	MANUAL CLEANING, LOW TYPE					60115A-SA 	SEMI-AUTOMATIC, LOW TYPE				
	TYPE NO.	PIPE SIZE	FLOW RATE GPM	GREASE CAP. LBS.	LIST PRICE		TYPE NO.	PIPE SIZE	FLOW RATE GPM	GREASE CAP. LBS.	LIST PRICE
	60115A	2"	20	40	\$16,648.00		60115A-SA	3	35	70	\$39,043.00
	60117A	3	35	70	21,439.00		ADD FOR OPTIONS:				
	ADD FOR OPTIONS: -65 \$366.00 -85 252.00 -66 512.00 -68 \$0.00 *2" Sizes Normally Furnished with 3" x 2" Reducing Bushings						-65 \$366.00 -66 \$495.00				

60210A 	MANUAL CLEANING TYPE, HIGH VOLUME										
	TYPE NO.	PIPE SIZE	FLOW RATE GPM	GREASE CAP. LBS.	LIST PRICE	-EXT 6"	Ea. Add'l Inch Ext.	-60	-61	-ISI	-HD
	60213A	4	150	300	\$57,164.00	\$6,789.00	\$524.00	\$5,216.00	\$8,397.00	\$6,459.00	\$25,687.00
	60214A	5	200	400	82,925.00	12,223.00	551.00	5,586.00	9,809.00	6,788.00	29,292.00
	60215A	5	250	500	96,533.00	15,185.00	592.00	7,451.00	13,233.00	7,162.00	40,441.00
60216A	6	350	700	126,398.00	21,091.00	760.00	9,427.00	15,831.00	9,045.00	61,215.00	
60217A	6	500	1000	164,809.00	31,693.00	902.00	11,195.00	18,821.00	10,719.00	86,135.00	
ADD FOR OPTIONS:											
-60 ABOVE -85 \$252.00 -HD ABOVE -61 ABOVE -EXT ABOVE -ISI ABOVE											

Grease Interceptor Option Descriptions

- | | | | |
|------|--|-----|--|
| -EXT | Extension, 6" Standard, Specify Extension Height | -62 | 4" Inlet and Outlet Available on Standard 3" Sizes |
| -HD | Heavy-Duty Cover | -65 | Hub Inlet, Spigot Outlet, 2 |
| -ISI | Integrated Solids Interceptor | -66 | Hub Inlet, Spigot Outlet, 3 |
| -60 | Anchor Flange | -68 | 3" Inlet and Outlet Avail on Std 2" Sizes |
| -61 | Flange and Clamp Device | -85 | Enzymatic Port |

60500B 	DRAW-OFF, GRAVITY TYPE								
	TYPE NO.	PIPE SIZE	FLOW RATE GPM	LIST PRICE	FOR OPTIONS, ADD TO LIST PRICE				
					-EXT 6"	Ea. Add'l Inch Ext.	-60†	-61†	-HD
60503B	2	10	\$9,294.00	\$8,700.00	\$382.00	\$2,374.00	\$2,852.00	\$9,895.00	
60504B	2	15	12,765.00	8,815.00	426.00	2,374.00	2,852.00	10,640.00	
60505B	3*	20	15,440.00	9,075.00	476.00	2,562.00	2,852.00	11,269.00	
60506B	3*	25	16,756.00	9,339.00	551.00	2,668.00	3,177.00	11,894.00	
60507B	3*	35	20,369.00	9,687.00	592.00	2,802.00	3,304.00	13,141.00	
60508B	3*	50	27,406.00	11,566.00	694.00	2,856.00	3,761.00	13,769.00	
ADD FOR OPTIONS:									
-60 ABOVE -EXT ABOVE -HD ABOVE									
-61 ABOVE									
* 3" Sizes Normally Furnished with 4" x 3" Reducing Bushings. †Only Available with -EXT Option									

60500B-EST 	DRAW-OFF, GRAVITY TYPE w/EXTERNAL STORAGE TANK									
	TYPE NO.	PIPE SIZE	FLOW RATE GPM	TANK CAP. GAL.	LIST PRICE	FOR OPTIONS, ADD TO LIST PRICE				
						-EXT 6"	Ea. Add'l Inch Ext.	-60	-61	-HD
60503B-EST-5	2	10	5	\$13,955.00	\$13,050.00	\$538.00	\$3,534.00	\$4,270.00	\$15,744.00	
60503B-EST-50	2	10	50	19,723.00	15,008.00	623.00	4,057.00	4,905.00	18,107.00	
60504B-EST-6	2	15	6	19,139.00	13,225.00	647.00	3,534.00	4,270.00	16,758.00	
60504B-EST-50	2	15	50	20,811.00	15,219.00	740.00	4,057.00	4,905.00	19,278.00	
60505B-EST-8	3*	20	8	23,160.00	13,628.00	736.00	3,534.00	4,270.00	17,740.00	
60505B-EST-50	3*	20	50	25,638.00	15,672.00	847.00	4,057.00	4,905.00	20,396.00	
60506B-EST-50	3*	25	50	25,119.00	13,749.00	805.00	4,007.00	4,670.00	18,386.00	
60506B-EST-100	3*	25	100	27,954.00	14,432.00	824.00	4,007.00	4,670.00	20,223.00	
60507B-EST-50	3*	35	50	30,539.00	14,238.00	874.00	4,095.00	4,830.00	19,349.00	
60507B-EST-100	3*	35	100	33,376.00	14,958.00	893.00	4,095.00	4,830.00	21,271.00	
60508B-EST-50	3*	50	50	34,611.00	16,251.00	993.00	4,162.00	5,529.00	18,493.00	
60508B-EST-100	3*	50	100	40,375.00	16,969.00	1,015.00	4,162.00	5,529.00	20,325.00	
ADD FOR OPTIONS:										
-19 \$3,848.00 -61 ABOVE -HD ABOVE										
-60† ABOVE -EXT ABOVE										
* 3" Sizes Normally Furnished with 4" x 3" Reducing Bushings. †Only Available with -EXT Option										

60610A 	DRAW-OFF TYPE, HIGH VOLUME								
	TYPE NO.	PIPE SIZE	FLOW RATE GPM	LIST PRICE	FOR OPTIONS, ADD TO LIST PRICE				
					-EXT 6"	Ea. Add'l Inch Ext.	-60*	-61*	-HD
60611A	3	75	\$47,475.00	\$6,521.00	\$426.00	\$2,830.00	\$5,643.00	\$14,543.00	
60612A	4	100	51,488.00	6,789.00	455.00	3,479.00	6,311.00	19,993.00	
60613A	4	150	63,748.00	7,335.00	524.00	4,857.00	7,827.00	25,687.00	
60614A	5	200	90,064.00	10,495.00	551.00	5,210.00	9,137.00	29,292.00	
60615A	5	250	104,305.00	13,647.00	592.00	6,960.00	11,847.00	40,441.00	
60616A	6	350	131,823.00	19,650.00	760.00	8,770.00	14,729.00	61,215.00	
60617A	6	500	191,515.00	30,596.00	902.00	10,410.00	17,530.00	86,135.00	
ADD FOR OPTIONS:									
-60* ABOVE -EXT ABOVE -HD ABOVE									
-61* ABOVE									
* Only Available with -EXT Option									

Oil Separator Option Descriptions

-EXT	Extension, 6" Standard, Specify Extension Height	-60	Anchor Flange
-HD	Heavy-Duty Cover	-61	Flange and Clamp Device
-19	Reclaim Tank Alarm		

 <p>EXTERNAL STORAGE TANK NOT SHOWN</p>	DRAW-OFF, GRAVITY TYPE w/EXTERNAL STORAGE TANK									
	TYPE NO.	PIPE SIZE	FLOW RATE GPM	TANK CAP. GAL	LIST PRICE	FOR OPTIONS, ADD TO LIST PRICE				
						-EXT 6"	Ea. Add'l Inch Ext.	-60*	-61*	-HD
	60611-EST	3	75	100	\$69,935.00	\$9,584.00	\$647.00	\$4,603.00	\$8,328.00	\$21,372.00
	60612-EST	4	100	250	77,250.00	10,184.00	694.00	5,264.00	9,446.00	30,021.00
	60613-EST	4	150	250	95,617.00	10,987.00	790.00	7,279.00	11,719.00	38,518.00
	60614-EST	5	200	250	126,615.00	14,781.00	790.00	7,786.00	13,697.00	41,247.00
	60615-EST	5	250	500	146,661.00	19,174.00	858.00	9,761.00	16,618.00	56,676.00
	60616-EST	6	350	500	185,390.00	27,639.00	1,067.00	12,317.00	20,673.00	81,936.00
	60617-EST	6	500	500	255,747.00	41,110.00	1,258.00	14,657.00	24,629.00	121,051.00
ADD FOR OPTIONS:										
-19 \$3,848.00 -61* ABOVE -HD ABOVE										
-60 ABOVE -EXT ABOVE										
* Only Available with -Ext Option										

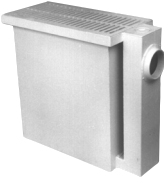
	OIL SEDIMENT INTERCEPTOR		
	TYPE NO.	PIPE SIZE	LIST PRICE
	60816	2	\$6,117.00
	60817	4	16,497.00
	60818	4	23,459.00
60819	4	34,763.00	

	SOLIDS INTERCEPTOR TOP ACCESS ON-FLOOR TRAP TYPE		
	TYPE NO.	PIPE SIZE	LIST PRICE
	61042A	2	\$8,256.00
	61043A	3	8,256.00
	61044A	4	8,256.00
ADD FOR OPTIONS:			
-15 \$2,034.00 -EXT* \$1,402.00			
-16 1,327.00			
*6" Standard, Each Add'l. Inch..... \$154.00			

	SOLIDS INTERCEPTOR BOTTOM ACCESS FIXTURE TRAP TYPE			
	TYPE NO.	INLET	OUTLET	LIST PRICE
	61001-1/4	1-1/4	1-1/2	\$2,872.00
	61001-1/2	1-1/2	1-1/2	2,872.00
	ADD FOR OPTIONS:			
-1 Deduct \$1,302.00 -30 Deduct \$380.00				
-3 0.00 -CP POA*				
• PRICE ON APPLICATION				

	SOLIDS INTERCEPTOR TOP ACCESS IN-LINE TYPE		
	TYPE NO.	PIPE SIZE	LIST PRICE
	61072	2	\$5,150.00
	61073	3	8,527.00
	61074	4	11,883.00
-4 \$2,039.00 -86 \$0.00			
-15 \$2,525.00			

	SOLIDS INTERCEPTOR CAST IRON TOP ACCESS FIXTURE TRAP TYPE		
	TYPE NO.	PIPE SIZE	LIST PRICE
	61031-1/2-1	1-1/2	\$2,135.00
	61032-1	2	2,135.00
	-26 \$1,180.00 -30 \$609.00		

	SOLIDS INTERCEPTOR TOP ACCESS IN-LINE TYPE		
	TYPE NO.	PIPE SIZE	LIST PRICE
	61084	4	\$20,159.00
	61085	5	20,159.00
	61086	6	20,159.00
-4 \$4,511.00 -86 \$0.00			
-15 \$3,303.00			

Oil & Solids Interceptor Option Descriptions

- | | |
|--|--|
| -EXT Extension, 6" Standard, Specify Extension Height | -16 Monel Screens |
| -HD Heavy-Duty Cover | -19 Reclaim Tank Alarm |
| -CP Chrome Plated Bronze | -26 Cast Aluminum |
| -1 Painted Cast Iron | -30 Acid-Resisting Cast Iron Inside and Outside |
| -3 Polished Bronze | -60 Anchor Flange |
| -4 Galvanized Cast Iron Parts | -61 Flange and Clamp Device |
| -15 Stainless Steel Basket | -86 Flat Bottom Basket |

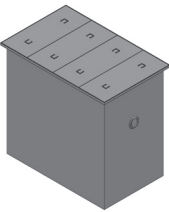
	SAND INTERCEPTOR					
	TYPE NO.	CAPACITY CUBIC FT.	SIZE GALLONS	LIST PRICE	FOR OPTIONS, ADD TO LIST PRICE	
					-EXT UP TO 6"	-HD
	61091	45	340	\$70,169.00	\$2,133.00	\$2,738.00
	61092	54	400	103,506.00	2,618.00	3,442.00
	61093	72	540	POA•	POA•	POA•
	61094	81	610	POA•	POA•	POA•
	61095	90	670	POA•	POA•	POA•
61096	108	810	POA•	POA•	POA•	
61097	135	1,010	POA•	POA•	POA•	
ADD FOR OPTIONS:						
-EXT ABOVE -HD ABOVE						
• PRICE ON APPLICATION						

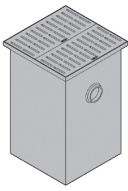
	SAND/SEDIMENT INTERCEPTOR										
	TYPE NO.	PIPE SIZE	FLOW RATE GPM	# OF GRATES	LIST PRICE	FOR OPTIONS, ADD TO LIST PRICE					
						-EXT 6"	Each Add'l Inch Ext.	-HD	-61	-7	-17-H20
	61103	4	20	2	\$21,911.00	\$1,344.00	\$150.00	\$4,211.00	\$3,661.00	\$4,495.00	\$6,687.00
	61104	4	50	4	37,158.00	2,087.00	222.00	8,420.00	6,596.00	8,990.00	12,707.00
	61105	4	150	8	112,292.00	3,733.00	383.00	16,848.00	9,809.00	17,980.00	29,210.00
	61106	6	250	12	155,961.00	5,612.00	570.00	30,407.00	15,831.00	26,972.00	42,568.00
	61107	8	500	20	208,996.00	9,515.00	963.00	42,100.00	18,821.00	44,953.00	65,854.00
ADD FOR OPTIONS:											
-61 ABOVE -EXT ABOVE -HD ABOVE											

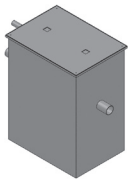
	RICE INTERCEPTOR		
	TYPE NO.	PIPE SIZE	LIST PRICE
	61202	3	POA•
	61203	4	POA•
	61204	4	POA•
	61205	4	POA•
	61207	6	POA•
	ADD FOR OPTIONS:		
-SS POA• -T NC			
• PRICE ON APPLICATION			

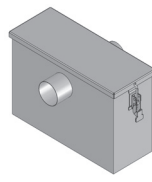
	SOLIDS INTERCEPTOR IN-LINE TYPE			
	TYPE NO.	PIPE SIZE	FLOW RATE GPM	LIST PRICE
	61303	3	50	POA•
	61304	4	100	POA•
	ADD FOR OPTIONS:			
	-SS POA•			
	• PRICE ON APPLICATION			

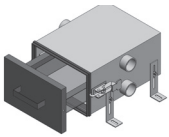

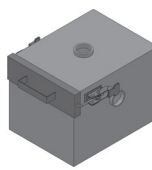





	SOLIDS INTERCEPTOR DRAWER TYPE, SIDE INLET		
	TYPE NO.	PIPE SIZE	LIST PRICE
	61402	2	\$13,752.00
	ADD FOR OPTIONS:		
	-316 \$2,749.00 -T POA•		
	• PRICE ON APPLICATION		

	SOLIDS INTERCEPTOR DRAWER TYPE, TOP INLET		
	TYPE NO.	PIPE SIZE	LIST PRICE
	61502	2	\$13,752.00
	ADD FOR OPTIONS:		
	-316 \$2,749.00 -T POA•		
	• PRICE ON APPLICATION		

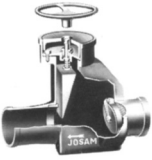
	LINT INTERCEPTOR						
	TYPE NO.	PIPE SIZE	FLOW RATE GPM	MAX. NUMBER OF WASHERS	LIST PRICE	FOR OPTIONS, ADD TO LIST PRICE	
						-EXT 6"	Ea. Add'l Inch Ext.
	61805	3	70	7	\$21,366.00	\$7,710.00	\$481.00
	61806	4	200	20	30,420.00	7,710.00	542.00
	61807	6	300	30	35,370.00	9,339.00	600.00
	61808	6	400	40	40,332.00	10,099.00	699.00

Interceptors Option Descriptions

- | | | | |
|---------|---|------|--|
| -316 | Type 316 L Stainless Steel | -EXT | Extension, 6" Standard, Specify Extension Height |
| -61 | Flange and Clamp Device | -HD | Heavy-Duty Cover |
| -7 | Ductile Iron Grates | -SS | Stainless Steel |
| -17-H20 | Ductile Iron Grates with Additional Welded Supports | -T | NPT Threaded Connections |

<p>67100A</p> 	<p>BALL-FLOAT ADAPTER TYPE</p> <table border="1"> <thead> <tr> <th colspan="3">LIST PRICE</th> </tr> <tr> <th>PIPE SIZE</th> <th>2", 3", 4"</th> <th>6"</th> </tr> </thead> <tbody> <tr> <td></td> <td>\$962.00</td> <td>\$1,996.00</td> </tr> </tbody> </table> <p>ADD FOR OPTIONS:</p> <table> <tr> <td>-5 (2" - 4")</td> <td>\$154.00</td> <td>-35</td> <td>\$257.00</td> </tr> <tr> <td>-5 (6")</td> <td>393.00</td> <td></td> <td></td> </tr> </table>	LIST PRICE			PIPE SIZE	2", 3", 4"	6"		\$962.00	\$1,996.00	-5 (2" - 4")	\$154.00	-35	\$257.00	-5 (6")	393.00			<p>67650</p> 	<p>COMBINED DRAIN/SWING-CHECK TYPE</p> <table border="1"> <thead> <tr> <th colspan="3">LIST PRICE</th> </tr> <tr> <th>PIPE SIZE</th> <th>3", 4"</th> <th>6"</th> </tr> </thead> <tbody> <tr> <td></td> <td>\$3,032.00</td> <td>\$4,563.00</td> </tr> </tbody> </table> <p>ADD FOR OPTIONS:</p> <table> <tr> <td>-1 (3", 4")</td> <td>\$1,435.00</td> <td>-25</td> <td>\$436.00</td> </tr> <tr> <td>-1 (6")</td> <td>1,247.00</td> <td>-LBV (3", 4")</td> <td>Ded. 639.00</td> </tr> <tr> <td>-2 (3", 4")</td> <td>962.00</td> <td>-LBV (6")</td> <td>Ded. 1,122.00</td> </tr> <tr> <td>-2 (6")</td> <td>795.00</td> <td>-VP</td> <td>240.00</td> </tr> <tr> <td>-5</td> <td>962.00</td> <td></td> <td></td> </tr> </table>	LIST PRICE			PIPE SIZE	3", 4"	6"		\$3,032.00	\$4,563.00	-1 (3", 4")	\$1,435.00	-25	\$436.00	-1 (6")	1,247.00	-LBV (3", 4")	Ded. 639.00	-2 (3", 4")	962.00	-LBV (6")	Ded. 1,122.00	-2 (6")	795.00	-VP	240.00	-5	962.00		
LIST PRICE																																																	
PIPE SIZE	2", 3", 4"	6"																																															
	\$962.00	\$1,996.00																																															
-5 (2" - 4")	\$154.00	-35	\$257.00																																														
-5 (6")	393.00																																																
LIST PRICE																																																	
PIPE SIZE	3", 4"	6"																																															
	\$3,032.00	\$4,563.00																																															
-1 (3", 4")	\$1,435.00	-25	\$436.00																																														
-1 (6")	1,247.00	-LBV (3", 4")	Ded. 639.00																																														
-2 (3", 4")	962.00	-LBV (6")	Ded. 1,122.00																																														
-2 (6")	795.00	-VP	240.00																																														
-5	962.00																																																
<p>67360</p> 	<p>SHEAR-GATE & SWING-CHECK TYPE</p> <table border="1"> <thead> <tr> <th colspan="3">LIST PRICE</th> </tr> <tr> <th>PIPE SIZE</th> <th>67360</th> <th>67360-DH</th> </tr> </thead> <tbody> <tr> <td>3", 4"</td> <td>\$8,327.00</td> <td>\$8,327.00</td> </tr> <tr> <td>5", 6"</td> <td>12,258.00</td> <td>12,258.00</td> </tr> </tbody> </table> <p>ADD FOR OPTIONS:</p> <table> <tr> <td>-15</td> <td>\$0.00</td> <td>-29 (3", 4")</td> <td>\$4,803.00</td> </tr> <tr> <td>-28 (3", 4")</td> <td>3,432.00</td> <td>-29 (5", 6")</td> <td>5,255.00</td> </tr> <tr> <td>-28 (5", 6")</td> <td>3,936.00</td> <td>-DH</td> <td>0.00</td> </tr> </table>	LIST PRICE			PIPE SIZE	67360	67360-DH	3", 4"	\$8,327.00	\$8,327.00	5", 6"	12,258.00	12,258.00	-15	\$0.00	-29 (3", 4")	\$4,803.00	-28 (3", 4")	3,432.00	-29 (5", 6")	5,255.00	-28 (5", 6")	3,936.00	-DH	0.00	<p>67720</p> 	<p>HUB INLET, SWING-CHECK TYPE</p> <table border="1"> <thead> <tr> <th colspan="3">LIST PRICE</th> </tr> <tr> <th>PIPE SIZE</th> <th>3"</th> <th>4"</th> </tr> </thead> <tbody> <tr> <td></td> <td>\$901.00</td> <td>\$1,308.00</td> </tr> </tbody> </table> <p>ADD FOR OPTIONS:</p> <table> <tr> <td>-15</td> <td>\$0.00</td> </tr> </table>	LIST PRICE			PIPE SIZE	3"	4"		\$901.00	\$1,308.00	-15	\$0.00											
LIST PRICE																																																	
PIPE SIZE	67360	67360-DH																																															
3", 4"	\$8,327.00	\$8,327.00																																															
5", 6"	12,258.00	12,258.00																																															
-15	\$0.00	-29 (3", 4")	\$4,803.00																																														
-28 (3", 4")	3,432.00	-29 (5", 6")	5,255.00																																														
-28 (5", 6")	3,936.00	-DH	0.00																																														
LIST PRICE																																																	
PIPE SIZE	3"	4"																																															
	\$901.00	\$1,308.00																																															
-15	\$0.00																																																
<p>67400</p> 	<p>NO-HUB SWING-CHECK TYPE</p> <table border="1"> <thead> <tr> <th colspan="5">LIST PRICE</th> </tr> <tr> <th>PIPE SIZE</th> <th>2"</th> <th>3"</th> <th>4"</th> <th>6"</th> </tr> </thead> <tbody> <tr> <td></td> <td>\$2,157.00</td> <td>\$3,375.00</td> <td>\$4,155.00</td> <td>\$5,312.00</td> </tr> </tbody> </table>	LIST PRICE					PIPE SIZE	2"	3"	4"	6"		\$2,157.00	\$3,375.00	\$4,155.00	\$5,312.00	<p>67800</p> 	<p>HUB INLET, SWING-CHECK TYPE</p> <table border="1"> <thead> <tr> <th colspan="3">LIST PRICE</th> </tr> <tr> <th>PIPE SIZE</th> <th>6"</th> <th>8"</th> </tr> </thead> <tbody> <tr> <td></td> <td>\$3,734.00</td> <td>\$4,543.00</td> </tr> </tbody> </table> <p>ADD FOR OPTIONS:</p> <table> <tr> <td>-4</td> <td>\$1,315.00</td> <td>-15</td> <td>\$0.00</td> </tr> </table>	LIST PRICE			PIPE SIZE	6"	8"		\$3,734.00	\$4,543.00	-4	\$1,315.00	-15	\$0.00																		
LIST PRICE																																																	
PIPE SIZE	2"	3"	4"	6"																																													
	\$2,157.00	\$3,375.00	\$4,155.00	\$5,312.00																																													
LIST PRICE																																																	
PIPE SIZE	6"	8"																																															
	\$3,734.00	\$4,543.00																																															
-4	\$1,315.00	-15	\$0.00																																														
<p>67500</p> 	<p>HUB & SPIGOT SWING-CHECK TYPE</p> <table border="1"> <thead> <tr> <th colspan="4">LIST PRICE</th> </tr> <tr> <th>PIPE SIZE</th> <th>2"</th> <th>3"</th> <th>4"</th> </tr> </thead> <tbody> <tr> <td></td> <td>\$2,157.00</td> <td>\$3,375.00</td> <td>\$4,155.00</td> </tr> <tr> <th>PIPE SIZE</th> <th>6"</th> <th>8"</th> <td></td> </tr> <tr> <td></td> <td>\$5,970.00</td> <td>\$8,386.00</td> <td></td> </tr> </tbody> </table> <p>ADD FOR OPTIONS:</p> <table> <tr> <td>-5 (2" - 4")</td> <td>\$870.00</td> <td>-15</td> <td>\$0.00</td> </tr> <tr> <td>-5 (6" - 8")</td> <td>2,183.00</td> <td>-30</td> <td>673.00</td> </tr> <tr> <td>-10*</td> <td>0.00</td> <td></td> <td></td> </tr> </table> <p>* For Extension, Use -10 Option with Hub and Spigot Extension Pipe by Others.</p>	LIST PRICE				PIPE SIZE	2"	3"	4"		\$2,157.00	\$3,375.00	\$4,155.00	PIPE SIZE	6"	8"			\$5,970.00	\$8,386.00		-5 (2" - 4")	\$870.00	-15	\$0.00	-5 (6" - 8")	2,183.00	-30	673.00	-10*	0.00			<p>Backwater Valve Option Descriptions</p> <ul style="list-style-type: none"> -DH Double Hub -LBV Less Backwater Valve -VP Secured Face, Vandal-Proof Screws -1 Satin Finish Nikaloy Face -2 Satin Finish Bronze Face -4 Bronze Seat -5 Galvanized Cast Iron Parts -10 Threaded Bronze Cover -15 Open Flap -25 Flashing Clamp Device -28 12" Cast Iron Extension and Stem -29 24" Cast Iron Extension and Stem -30 2" Auxiliary Inlet with Bronze Plug -35 1/2" Primer Tap 															
LIST PRICE																																																	
PIPE SIZE	2"	3"	4"																																														
	\$2,157.00	\$3,375.00	\$4,155.00																																														
PIPE SIZE	6"	8"																																															
	\$5,970.00	\$8,386.00																																															
-5 (2" - 4")	\$870.00	-15	\$0.00																																														
-5 (6" - 8")	2,183.00	-30	673.00																																														
-10*	0.00																																																
<p>67600</p> 	<p>HUB & SPIGOT SWING-CHECK TYPE</p> <table border="1"> <thead> <tr> <th colspan="3">LIST PRICE</th> </tr> <tr> <th>TYPE NO.</th> <th>PIPE SIZE</th> <th></th> </tr> </thead> <tbody> <tr> <td>67610</td> <td>10"</td> <td>\$13,699.00</td> </tr> <tr> <td>67612</td> <td>12"</td> <td>17,775.00</td> </tr> </tbody> </table> <p>ADD FOR OPTIONS:</p> <table> <tr> <td>-15</td> <td>\$0.00</td> </tr> </table>	LIST PRICE			TYPE NO.	PIPE SIZE		67610	10"	\$13,699.00	67612	12"	17,775.00	-15	\$0.00																																		
LIST PRICE																																																	
TYPE NO.	PIPE SIZE																																																
67610	10"	\$13,699.00																																															
67612	12"	17,775.00																																															
-15	\$0.00																																																

	71300			QUARTER-TURN HYDRANT, BOX TYPE FOR NSF/ANSI 61		
	LIST PRICE					
	SIZE					
	6-1/4	71300-6-QTR	\$2,548.00			
	7-1/4	71300-7-QTR	2,548.00			
	9-1/4	71300-9-QTR	2,638.00			
	11-1/4	71300-11-QTR	2,638.00			
	13-1/4	71300-13-QTR	2,638.00			
	15-1/4	71300-15-QTR	2,775.00			
	17-1/4	71300-17-QTR	2,775.00			
ADD FOR OPTIONS:						
-52*	\$100.00	-91	\$348.00			
-54*	452.00	-95	348.00			
-72	0.00	-HD	2,041.00			
-74	150.00	-HD-52	2,139.00			
-81	231.00	-HD-54	2,041.00			
*SS Box Body						

	71600			YARD HYDRANT, BOX TYPE NON-FREEZE		
	LIST PRICE					
	SIZE	71600 3/4" Connection		71600-91 1" Connection		
	2' Bury	\$3,318.00		\$3,843.00		
	3' Bury	3,570.00		4,108.00		
	4' Bury	3,818.00		4,379.00		
	5' Bury	4,096.00		4,624.00		
	ADD FOR OPTIONS:					
	-52	\$0.00	-91	ABOVE		
	-80	3,351.00	-95	348.00		
-81*	231.00	-97	307.00			
*Requires -80						

	71350			QUARTER-TURN HYDRANT FOR NSF/ANSI 61		
	LIST PRICE					
	SIZE					
	3	71350-MC-QTR	\$1,432.00			
	4	71350-4-QTR	1,432.00			
	6	71350-6-QTR	1,432.00			
	8	71350-8-QTR	1,432.00			
	10	71350-10-QTR	1,516.00			
	12	71350-12-QTR	1,516.00			
	14	71350-14-QTR	1,516.00			
ADD FOR OPTIONS:						
-72	\$0.00	-91	348.00			
-74	151.00					
-EPCP	152.00					
-81	\$231.00					

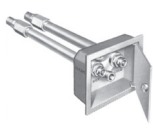
	71650			TRI-TEMP WALL HYDRANT, BOX TYPE NON-FREEZE		
	LIST PRICE					
	SIZE	71650 3/4" Connection		71650-91 1" Connection		
	6", 8" Wall	\$6,292.00		\$6,983.00		
	10", 12", 14" Wall	6,474.00		7,162.00		
	16", 18" Wall	7,025.00		7,716.00		
	20", 22", 24" Wall	7,378.00		8,069.00		
	ADD FOR OPTIONS:					
	-72	\$0.00	-81	\$231.00		
	-73	0.00	-91	ABOVE		
-74	150.00	-95	348.00			

	71400			YARD HYDRANT NON-FREEZE		
	LIST PRICE					
	SIZE		3/4" CONNECTION			
	2' Bury	\$1,919.00				
	3' Bury	2,022.00				
	4' Bury	2,133.00				
	5' Bury	2,233.00				
	6' Bury	2,334.00				

	71450			YARD HYDRANT, HEAVY-DUTY NON-FREEZE		
	LIST PRICE					
	SIZE	71450 3/4" Connection		71450 1" Connection		
	2' Bury	\$2,331.00		\$3,980.00		
	3' Bury	2,671.00		4,118.00		
	4' Bury	2,799.00		4,285.00		
	5' Bury	2,924.00		4,448.00		
	6' Bury	3,026.00		4,563.00		

Hydrant Option Descriptions					
-52	Satin Finish Bronze Face, SS Box				
-54	Satin Finish Nikaloy Face, SS Box				
-72	Wall Clamp				
-73	Solder Inlet Adapter				
-74	Union Elbow Assembly				
-80	Deep Box				
-81	Vacuum Breaker				
-91	1" Hose Pipe Threaded Outlet				
-95	Cylinder Vandal-Proof Lock				
-97	1/8" Tapped Drain Hole in Box				
-EPCP	Escutcheon Plate, Chrome-Plated				
-HD	Heavy Duty				
-HD-52	Heavy Duty Box, Satin Finish Bronze Face				
-HD-54	Heavy Duty Box, Satin Finish Nikaloy Face				

SHOCK ABSORBERS

75000



STAINLESS STEEL SHELL & ADAPTER

LIST PRICE

SIZE

- A
- B
- C
- D
- E
- F

- \$914.00
- 1,844.00
- 2,771.00
- 6,934.00
- 7,828.00
- 9,622.00

TRENCH DRAINS

76000



SUPER-FLO[®] 6" WIDE, RECTANGULAR

LIST PRICE

PIPE SIZE 2", 3", 4" \$1,717.00

ADD FOR OPTIONS:

- 1 \$1,836.00 -ARE \$1,061.00
- 2 1,583.00 -EXT 1,717.00
- 7 533.00 -VP 393.00
- 30 257.00 -X 0.00
- 40 531.00

2" and 3" Provided as 4" -X with Reducer.

76010



12" WIDE, RECTANGULAR

LIST PRICE

PIPE SIZE 3" - 6" \$4,026.00

ADD FOR OPTIONS:

- 1 \$2,272.00 -70 \$936.00
- 2 1,955.00 -70-40 1,520.00
- 7 1,466.00 -ARE 2,121.00
- 11 310.00 -EXT 4,026.00
- 30 246.00 -VP 393.00
- 40 1,063.00 -X 0.00

3" Provided as 4" -X with Reducer.

76200



FRAME & GRATE ASSEMBLY (C CLASS)

TYPE NO.

OVERALL WIDTH

LIST PRICE

- 76210
- 76220

- 6"
- 10"

- POA•
- POA•

• PRICE ON APPLICATION

76300

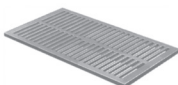

LIGHT-DUTY RECTANGULAR TRENCH DRAIN & ADDITIONAL SECTIONS

LIST PRICE

OPTIONS	76300 20" GRATE	76301 SINGLE GRATE & FRAME	76302 2-GRATE SECTION	76302 ADD'L. 20" 1-GRATE SECTION	76402 24" 2-GRATE SECTION	7640 ADD'L. 12" SECTIONS
	\$942.00	\$2,060.00	\$4,121.00	\$2,060.00	\$4,593.00	\$1,520.00

ADD FOR OPTIONS:

- | | | | | | | |
|------|------------|------------|------------|------------|------------|------------|
| -1 | \$3,534.00 | \$5,673.00 | \$8,990.00 | \$3,318.00 | \$9,348.00 | \$4,682.00 |
| -7 | 1,042.00 | 2,082.00 | 4,171.00 | 2,082.00 | 4,171.00 | 2,082.00 |
| -8-2 | 3,151.00 | 4,963.00 | 7,902.00 | 2,948.00 | 8,243.00 | 4,296.00 |
| -40 | 531.00 | 807.00 | 1,610.00 | 807.00 | 1,610.00 | 774.00 |
| -VP | N/A | 775.00 | 1,556.00 | 775.00 | 1,556.00 | 775.00 |

76500



MEDIUM-DUTY RECTANGULAR TRENCH DRAIN & ADDITIONAL SECTIONS

LIST PRICE

OPTIONS	76500 24" GRATE	76501 SINGLE GRATE & FRAME	76502 2-GRATE SECTION	76502 ADD'L. 24" 1-GRATE SECTION	76602 24" 2-GRATE SECTION	7660 ADD'L. 12" SECTIONS
	\$1,199.00	\$3,253.00	\$5,019.00	\$3,153.00	\$6,008.00	\$2,755.00

ADD FOR OPTIONS:

- | | | | | | | |
|------|------------|------------|-------------|------------|-------------|------------|
| -1 | \$4,492.00 | \$6,454.00 | \$11,467.00 | \$5,019.00 | \$13,440.00 | \$6,980.00 |
| -7 | 2,079.00 | 2,079.00 | 4,161.00 | 2,079.00 | 4,161.00 | 2,079.00 |
| -8-2 | 4,173.00 | 5,859.00 | 10,372.00 | 4,515.00 | 12,061.00 | 6,202.00 |
| -40 | 2,274.00 | 2,274.00 | 4,549.00 | 2,274.00 | 4,549.00 | 2,274.00 |
| -VP | N/A | 775.00 | 1,556.00 | 775.00 | 1,556.00 | 775.00 |

TRENCH DRAINS (cont'd)

76700 76800	HEAVY-DUTY RECTANGULAR TRENCH DRAIN & ADDITIONAL SECTIONS					
	LIST PRICE					
OPTIONS	76700 24" GRATE	76701 SINGLE GRATE & FRAME	76702 2-GRATE SECTION	76702 ADD'L. 24" 1-GRATE SECTION	76802 24" 2-GRATE SECTION	7680 ADD'L. 12" SECTIONS
	\$2,117.00	\$4,381.00	\$7,647.00	\$3,267.00	\$6,370.00	\$2,770.00
ADD FOR OPTIONS:						
-1	\$6,825.00	\$10,727.00	\$20,260.00	\$9,530.00	\$17,510.00	\$7,261.00
-7	2,248.00	2,248.00	4,491.00	2,248.00	4,491.00	2,248.00
-8-2	6,311.00	9,427.00	18,077.00	8,658.00	15,524.00	6,505.00
-40	2,128.00	2,550.00	5,104.00	2,550.00	5,104.00	2,550.00
-VP	N/A	775.00	1,556.00	775.00	1,556.00	775.00



Trench Drain Option Descriptions

- ARE Acid Resistant Coating on Cast Iron Parts
- EXT Extension Section
- VP * Secured Grate, Vandal-Proof Screws
- 1 Satin Finish Nikaloy Top
- 2 Satin Finish Bronze Top
- 7 Ductile Iron Grate
- 8-2 All Bronze with Satin Finish Top
- 11 Convex Grate
- 30 Flashing Clamp Device
- 40 Galvanized Cast Iron Parts
- 70 Sediment Bucket
- 70-40 Sediment Bucket, Galvanized
- Outlet
- X Inside Caulk Outlet

* For Installations Exposed to Vehicular Traffic, Specify -VP, Secured Grate











MISCELLANEOUS PRODUCTS

85220	5" x 7" 90° ANGLE STRAINER			85810	RECTANGULAR PATTERN DRAIN		
	LIST PRICE				LIST PRICE		
PIPE SIZE	2", 3", 4"	\$2,735.00		PIPE SIZE	2", 3", 4"	\$807.00	
ADD FOR OPTIONS:				ADD FOR OPTIONS:			
-3	\$1,116.00	-47	\$972.00	-1	\$996.00	-T	\$129.00
-41	457.00	-T	0.00	-2	894.00	-TSI	POA
-42	310.00	-VP	288.00	-3	1,100.00	-VP	240.00
				-42	245.00	-X	0.00
				-47	817.00		
85800	RECTANGULAR PATTERN DRAIN			85903-Z	CAST IRON DRAIN w/MEDIUM-DUTY SLOTTED GRATE		
	LIST PRICE				LIST PRICE		
PIPE SIZE	4", 5", 6"	\$1,116.00		PIPE SIZE	3"	\$269.00	
ADD FOR OPTIONS:				ADD FOR OPTIONS:			
-1	\$1,623.00	-47	\$972.00	-47	\$197.00	-TSI	POA
-2	1,454.00	-T	0.00	-F4-93	320.00	-Z	STD
-3	1,100.00	-TSI	POA				
-42	245.00	-VP	240.00				



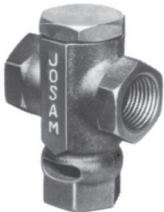

Miscellaneous Product Option Descriptions

- F4-93 Round Cast Iron Funnel
- TSI Trap Seal Insert
- VP Secured Grate, Vandal-Proof Screws
- 1 Satin Finish Nikaloy Top
- 2 Satin Finish Bronze Top
- 3 Chrome Plated Bronze Face
- 41 Clamp Device
- 42 Ground Screw
- 47 Galvanized Cast Iron Parts
- Outlets
- T Threaded Outlet
- X Inside Caulk Outlet
- Z No-Hub Outlet

<p>F52 & F53</p> 	<p>CAST IRON THREADED FUNNEL</p> <table border="1"> <thead> <tr> <th colspan="2">LIST PRICE</th> </tr> <tr> <th>F52</th> <th>F53</th> </tr> </thead> <tbody> <tr> <td>\$641.00</td> <td>\$719.00</td> </tr> </tbody> </table>	LIST PRICE		F52	F53	\$641.00	\$719.00	<p>88270</p> 	<p>PLASTIC PIPE SLEEVE</p> <table border="1"> <thead> <tr> <th colspan="3">LIST PRICE</th> </tr> <tr> <th>MODEL</th> <th>SLEEVE SIZE</th> <th></th> </tr> </thead> <tbody> <tr> <td>88273</td> <td>3"</td> <td>\$22.00</td> </tr> <tr> <td>88274</td> <td>4"</td> <td>32.00</td> </tr> <tr> <td>88276</td> <td>6"</td> <td>42.00</td> </tr> <tr> <td>88278</td> <td>8"</td> <td>68.00</td> </tr> </tbody> </table>	LIST PRICE			MODEL	SLEEVE SIZE		88273	3"	\$22.00	88274	4"	32.00	88276	6"	42.00	88278	8"	68.00			
LIST PRICE																														
F52	F53																													
\$641.00	\$719.00																													
LIST PRICE																														
MODEL	SLEEVE SIZE																													
88273	3"	\$22.00																												
88274	4"	32.00																												
88276	6"	42.00																												
88278	8"	68.00																												
<p>88100</p> 	<p>P TRAP</p> <table border="1"> <thead> <tr> <th colspan="2">LIST PRICE</th> </tr> <tr> <th>PIPE SIZE</th> <th></th> </tr> </thead> <tbody> <tr> <td>2"</td> <td>\$731.00</td> </tr> <tr> <td>3"</td> <td>1,116.00</td> </tr> <tr> <td>4"</td> <td>1,659.00</td> </tr> </tbody> </table> <p>ADD FOR OPTIONS:</p> <p>-51\$246.00 -60\$336.00</p>	LIST PRICE		PIPE SIZE		2"	\$731.00	3"	1,116.00	4"	1,659.00	<p>88300</p> 	<p>TRAP SEAL PRIMER VALVE</p> <table border="1"> <thead> <tr> <th colspan="2">LIST PRICE</th> </tr> <tr> <th>88300</th> <th>POA•</th> </tr> </thead> <tbody> <tr> <td colspan="2">88280 Less Distribution Unit.....\$2,240.00</td> </tr> </tbody> </table> <p>• PRICE ON APPLICATION</p>	LIST PRICE		88300	POA•	88280 Less Distribution Unit.....\$2,240.00												
LIST PRICE																														
PIPE SIZE																														
2"	\$731.00																													
3"	1,116.00																													
4"	1,659.00																													
LIST PRICE																														
88300	POA•																													
88280 Less Distribution Unit.....\$2,240.00																														
<p>88210</p> 	<p>DEEP SEAL TRAP, FUNNEL INLET</p> <table border="1"> <thead> <tr> <th colspan="2">LIST PRICE</th> </tr> <tr> <th>PIPE SIZE</th> <th></th> </tr> </thead> <tbody> <tr> <td>2"</td> <td>\$1,213.00</td> </tr> <tr> <td>3"</td> <td>1,402.00</td> </tr> </tbody> </table> <p>ADD FOR OPTIONS:</p> <p>-8 (2")\$947.00 -51\$246.00 -8 (3")2,106.00 -72336.00 -ARE.....475.00</p>	LIST PRICE		PIPE SIZE		2"	\$1,213.00	3"	1,402.00	<p>88400</p> 	<p>NO-HUB SPIGOT ADAPTER</p> <table border="1"> <thead> <tr> <th colspan="2">LIST PRICE</th> </tr> <tr> <th>PIPE SIZE</th> <th></th> </tr> </thead> <tbody> <tr> <td>2"</td> <td>\$154.00</td> </tr> <tr> <td>3"</td> <td>228.00</td> </tr> <tr> <td>4"</td> <td>361.00</td> </tr> <tr> <td>6"</td> <td>1,100.00</td> </tr> <tr> <td>8"</td> <td>1,233.00</td> </tr> </tbody> </table> <p>ADD FOR OPTIONS:</p> <p>-40\$141.00 -50\$246.00 -49246.00</p>	LIST PRICE		PIPE SIZE		2"	\$154.00	3"	228.00	4"	361.00	6"	1,100.00	8"	1,233.00					
LIST PRICE																														
PIPE SIZE																														
2"	\$1,213.00																													
3"	1,402.00																													
LIST PRICE																														
PIPE SIZE																														
2"	\$154.00																													
3"	228.00																													
4"	361.00																													
6"	1,100.00																													
8"	1,233.00																													
<p>88240</p> 	<p>TSI® - TRAP SEAL INSERT</p> <table border="1"> <thead> <tr> <th colspan="3">LIST PRICE</th> </tr> <tr> <th>MODEL</th> <th>PIPE SIZE</th> <th></th> </tr> </thead> <tbody> <tr> <td>88242</td> <td>2"</td> <td>POA</td> </tr> <tr> <td>88243</td> <td>3"</td> <td>POA</td> </tr> <tr> <td>88243-1/2</td> <td>3-1/2"</td> <td>POA</td> </tr> <tr> <td>88244</td> <td>4"</td> <td>POA</td> </tr> </tbody> </table>	LIST PRICE			MODEL	PIPE SIZE		88242	2"	POA	88243	3"	POA	88243-1/2	3-1/2"	POA	88244	4"	POA	<p>88450</p> 	<p>TRAP PRIMER ADAPTER</p> <table border="1"> <thead> <tr> <th colspan="3">LIST PRICE</th> </tr> <tr> <th>PIPE SIZE</th> <th>2", 3", 4"</th> <th></th> </tr> </thead> <tbody> <tr> <td></td> <td></td> <td>\$312.00</td> </tr> </tbody> </table>	LIST PRICE			PIPE SIZE	2", 3", 4"				\$312.00
LIST PRICE																														
MODEL	PIPE SIZE																													
88242	2"	POA																												
88243	3"	POA																												
88243-1/2	3-1/2"	POA																												
88244	4"	POA																												
LIST PRICE																														
PIPE SIZE	2", 3", 4"																													
		\$312.00																												
<p>88250</p> 	<p>TRAP SEAL PRIMER VALVE</p> <table border="1"> <thead> <tr> <th colspan="2">LIST PRICE</th> </tr> <tr> <th>88250</th> <th></th> </tr> </thead> <tbody> <tr> <td></td> <td>\$481.00</td> </tr> </tbody> </table> <p>ADD FOR OPTIONS:</p> <p>-10\$141.00</p>	LIST PRICE		88250			\$481.00	<p>88550</p> 	<p>HUB ADAPTER, THREADED OUTLET</p> <table border="1"> <thead> <tr> <th colspan="2">LIST PRICE</th> </tr> <tr> <th>PIPE SIZE</th> <th></th> </tr> </thead> <tbody> <tr> <td>3"</td> <td>\$246.00</td> </tr> <tr> <td>4"</td> <td>312.00</td> </tr> <tr> <td>5"</td> <td>647.00</td> </tr> <tr> <td>6"</td> <td>775.00</td> </tr> </tbody> </table> <p>ADD FOR OPTIONS:</p> <p>-40 (3", 4")\$113.00 -40 (6")\$197.00 -40 (5")171.00</p>	LIST PRICE		PIPE SIZE		3"	\$246.00	4"	312.00	5"	647.00	6"	775.00									
LIST PRICE																														
88250																														
	\$481.00																													
LIST PRICE																														
PIPE SIZE																														
3"	\$246.00																													
4"	312.00																													
5"	647.00																													
6"	775.00																													

	88560		HUB ADAPTER, THREADED OUTLET	
	LIST PRICE			
	PIPE SIZE			
	2"		\$154.00	
	3"		296.00	
	4"		393.00	
5"		647.00		
6"		753.00		
8"		1,378.00		
ADD FOR OPTIONS:				
-40 (2" - 4").....		\$129.00	-40 (5" - 8")	
			\$201.00	

	88950		FRESH AIR INLET	
	LIST PRICE			
	PIPE SIZE			
	2", 3", 4"		\$949.00	
	5", 6"		1,623.00	
	8"		2,586.00	
ADD FOR OPTIONS:				
-2 (2" - 4")		Deduct \$146.00		
-2 (5", 6")		Deduct \$348.00		
-2 (8")		Deduct \$614.00		

	88600		REDUCING HUB ADAPTER	
	LIST PRICE			
	TYPE NO.	PIPE SIZE		
	88603-2	2"	\$405.00	
	88604-2	2"	428.00	
	88604-2-1/2	2-1/2"	428.00	
88604-3	3"	432.00		
88606-4	4"	917.00		
ADD FOR OPTIONS:				
-40		\$129.00		







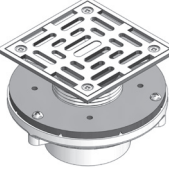

	88970		FRESH AIR INLET	
	LIST PRICE			
	PIPE SIZE			
	4"		\$1,504.00	
	5"		1,713.00	
	ADD FOR OPTIONS:			
-8-2.....		Deduct \$541.00	-VP	
			\$107.00	

	88900		AIR GAP	
	LIST PRICE			
	TYPE NO.			
	88900-1	\$499.00		
	88900-2	499.00		
	88900-3	595.00		
88900-4	879.00			
88900-5	2,078.00			
ADD FOR OPTIONS:				
-40		\$345.00		

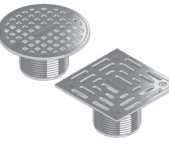
	88910		AIR GAP	
	LIST PRICE			
	PIPE SIZE			
	88910-1		\$512.00	
	88910-2		512.00	
	88910-3		561.00	
88910-4		714.00		
88910-5		714.00		
ADD FOR OPTIONS:				
-40		\$345.00		

Option Descriptions

- ARE Acid-Resisting Epoxy
- VP Secured Grate, Vandal-Proof Screws
- 2 Satin Finish Bronze Face
- 8 All Bronze
- 8-2 All Bronze with Satin Finish Face
- 10 Polished Chrome Plated
- 40 Galvanized Cast Iron Parts
- 49 3/4" Primer Tap
- 50 1/2" Primer Tap
- 51 Flushing Tap
- 60 Bronze Plug
- 72 Bronze Bucket
- 90 1/2" Female Copper Connection
- 91 1/2" Female Copper Union Connection

 <p>FD-100-A</p>	<p>LEVELEZE® II C.I. BODY w/5" ROUND TOP w/TWO-STAGE HEIGHT ADJUSTMENT</p> <table border="1"> <thead> <tr> <th colspan="2">LIST PRICE</th> </tr> </thead> <tbody> <tr> <td>PIPE SIZE</td> <td>FD-100-A</td> </tr> <tr> <td>2"-5"*</td> <td>\$702.00</td> </tr> </tbody> </table> <p>ADD FOR OPTIONS:</p> <table> <tr> <td>-TSI†</td> <td>POA</td> <td>-Y</td> <td>\$0.00</td> </tr> <tr> <td>-VP</td> <td>\$32.00</td> <td>-YGTC (2"-4")</td> <td>41.00</td> </tr> <tr> <td></td> <td></td> <td>-Z</td> <td>0.00</td> </tr> </table> <p>* 5" available in no-hub only †Available up to 4" only</p>	LIST PRICE		PIPE SIZE	FD-100-A	2"-5"*	\$702.00	-TSI†	POA	-Y	\$0.00	-VP	\$32.00	-YGTC (2"-4")	41.00			-Z	0.00	 <p>FD-210-4CP-SQ</p>	<p>PVC BODY w/SOLVENT WELD OUTLET AND 4" ADJUSTABLE SQUARE CHROME PLATED BRASS STRAINER</p> <table border="1"> <thead> <tr> <th colspan="2">LIST PRICE</th> </tr> </thead> <tbody> <tr> <td>PIPE SIZE</td> <td>FD-210-4CP-SQ</td> </tr> <tr> <td>2", 3", 4"</td> <td>\$404.00</td> </tr> </tbody> </table> <p>ADD FOR OPTIONS:</p> <table> <tr> <td>-TSI</td> <td>POA</td> </tr> </table>	LIST PRICE		PIPE SIZE	FD-210-4CP-SQ	2", 3", 4"	\$404.00	-TSI	POA																											
LIST PRICE																																																								
PIPE SIZE	FD-100-A																																																							
2"-5"*	\$702.00																																																							
-TSI†	POA	-Y	\$0.00																																																					
-VP	\$32.00	-YGTC (2"-4")	41.00																																																					
		-Z	0.00																																																					
LIST PRICE																																																								
PIPE SIZE	FD-210-4CP-SQ																																																							
2", 3", 4"	\$404.00																																																							
-TSI	POA																																																							
 <p>FD-100-S</p>	<p>LEVELEZE® II C.I. BODY w/5" SQUARE TOP w/TWO-STAGE HEIGHT ADJUSTMENT</p> <table border="1"> <thead> <tr> <th colspan="2">LIST PRICE</th> </tr> </thead> <tbody> <tr> <td>PIPE SIZE</td> <td>FD-100-S</td> </tr> <tr> <td>2"-5"*</td> <td>\$819.00</td> </tr> </tbody> </table> <p>ADD FOR OPTIONS:</p> <table> <tr> <td>-TSI†</td> <td>POA</td> <td>-Y</td> <td>\$0.00</td> </tr> <tr> <td>-VP</td> <td>\$32.00</td> <td>-YGTC (2"-4")</td> <td>41.00</td> </tr> <tr> <td></td> <td></td> <td>-Z</td> <td>0.00</td> </tr> </table> <p>* 5" available in no-hub only †Available up to 4" only</p>	LIST PRICE		PIPE SIZE	FD-100-S	2"-5"*	\$819.00	-TSI†	POA	-Y	\$0.00	-VP	\$32.00	-YGTC (2"-4")	41.00			-Z	0.00	 <p>4CP & 4CP-SQ</p>	<p>REPLACEMENT CHROME PLATED STRAINERS FOR FD-200 & FD-210 SE- RIES</p> <table border="1"> <thead> <tr> <th colspan="2">LIST PRICE</th> </tr> </thead> <tbody> <tr> <td>4CP</td> <td>\$257.00</td> </tr> <tr> <td>4CP-SQ</td> <td>297.00</td> </tr> </tbody> </table> <p>ADD FOR OPTIONS:</p> <table> <tr> <td>-TSI</td> <td>POA</td> </tr> </table>	LIST PRICE		4CP	\$257.00	4CP-SQ	297.00	-TSI	POA																											
LIST PRICE																																																								
PIPE SIZE	FD-100-S																																																							
2"-5"*	\$819.00																																																							
-TSI†	POA	-Y	\$0.00																																																					
-VP	\$32.00	-YGTC (2"-4")	41.00																																																					
		-Z	0.00																																																					
LIST PRICE																																																								
4CP	\$257.00																																																							
4CP-SQ	297.00																																																							
-TSI	POA																																																							
 <p>FD-200-4CP</p>	<p>CAST IRON BODY w/4" ADJUSTABLE ROUND CHROME PLATED BRASS STRAINER</p> <table border="1"> <thead> <tr> <th colspan="2">LIST PRICE</th> </tr> </thead> <tbody> <tr> <td>PIPE SIZE</td> <td>FD-200-4CP</td> </tr> <tr> <td>2"</td> <td>\$382.00</td> </tr> </tbody> </table> <p>ADD FOR OPTIONS:</p> <table> <tr> <td>-ST</td> <td>\$287.00</td> <td>-TSI</td> <td>POA</td> </tr> <tr> <td>-T</td> <td>0.00</td> <td>-Z</td> <td>0.00</td> </tr> </table>	LIST PRICE		PIPE SIZE	FD-200-4CP	2"	\$382.00	-ST	\$287.00	-TSI	POA	-T	0.00	-Z	0.00	 <p>FD-220</p>	<p>CAST IRON BODY w/6" SLOTTED CAST IRON, MEDIUM-DUTY GRATE</p> <table border="1"> <thead> <tr> <th colspan="2">LIST PRICE</th> </tr> </thead> <tbody> <tr> <td>PIPE SIZE</td> <td>FD-220</td> </tr> <tr> <td>2" Push-On (-Y)</td> <td>\$164.00</td> </tr> <tr> <td>3" No-Hub</td> <td>164.00</td> </tr> </tbody> </table> <p>ADD FOR OPTIONS:</p> <table> <tr> <td>-TSI</td> <td>POA</td> </tr> </table>	LIST PRICE		PIPE SIZE	FD-220	2" Push-On (-Y)	\$164.00	3" No-Hub	164.00	-TSI	POA																													
LIST PRICE																																																								
PIPE SIZE	FD-200-4CP																																																							
2"	\$382.00																																																							
-ST	\$287.00	-TSI	POA																																																					
-T	0.00	-Z	0.00																																																					
LIST PRICE																																																								
PIPE SIZE	FD-220																																																							
2" Push-On (-Y)	\$164.00																																																							
3" No-Hub	164.00																																																							
-TSI	POA																																																							
 <p>FD-200-4CP-SQ</p>	<p>CAST IRON BODY w/4" ADJUSTABLE SQUARE CHROME PLATED BRASS STRAINER</p> <table border="1"> <thead> <tr> <th colspan="2">LIST PRICE</th> </tr> </thead> <tbody> <tr> <td>PIPE SIZE</td> <td>FD-200-4CP-SQ</td> </tr> <tr> <td>2"</td> <td>\$423.00</td> </tr> </tbody> </table> <p>ADD FOR OPTIONS:</p> <table> <tr> <td>-ST</td> <td>\$287.00</td> <td>-TSI</td> <td>POA</td> </tr> <tr> <td>-T</td> <td>0.00</td> <td>-Z</td> <td>0.00</td> </tr> </table>	LIST PRICE		PIPE SIZE	FD-200-4CP-SQ	2"	\$423.00	-ST	\$287.00	-TSI	POA	-T	0.00	-Z	0.00	 <p>FD-250J-A</p>	<p>CAST IRON BODY w/ADJUSTABLE ROUND NIKALOY STRAINER AND NO-HUB BOTTOM OUTLET</p> <table border="1"> <thead> <tr> <th colspan="5">LIST PRICE</th> </tr> <tr> <th>PIPE SIZE</th> <th colspan="4">WITH STRAINER</th> </tr> </thead> <tbody> <tr> <td rowspan="2">4"</td> <td>5A</td> <td>6A</td> <td>7A</td> <td>8A</td> </tr> <tr> <td>\$508.00</td> <td>\$656.00</td> <td>\$775.00</td> <td>\$1,011.00</td> </tr> </tbody> </table> <p>ADD FOR OPTIONS:</p> <table> <tr> <td>-2</td> <td>Deduct \$44.00</td> <td>-CP (6A)</td> <td>\$171.00</td> </tr> <tr> <td>-80</td> <td>39.00</td> <td>-J</td> <td>184.00</td> </tr> <tr> <td>-92</td> <td>29.00</td> <td>-SS</td> <td>92.00</td> </tr> <tr> <td>-ARE</td> <td>35.00</td> <td>-TSI</td> <td>POA</td> </tr> <tr> <td>-CP (5A)</td> <td>171.00</td> <td>-VP</td> <td>32.00</td> </tr> </table>	LIST PRICE					PIPE SIZE	WITH STRAINER				4"	5A	6A	7A	8A	\$508.00	\$656.00	\$775.00	\$1,011.00	-2	Deduct \$44.00	-CP (6A)	\$171.00	-80	39.00	-J	184.00	-92	29.00	-SS	92.00	-ARE	35.00	-TSI	POA	-CP (5A)	171.00	-VP	32.00
LIST PRICE																																																								
PIPE SIZE	FD-200-4CP-SQ																																																							
2"	\$423.00																																																							
-ST	\$287.00	-TSI	POA																																																					
-T	0.00	-Z	0.00																																																					
LIST PRICE																																																								
PIPE SIZE	WITH STRAINER																																																							
4"	5A	6A	7A	8A																																																				
	\$508.00	\$656.00	\$775.00	\$1,011.00																																																				
-2	Deduct \$44.00	-CP (6A)	\$171.00																																																					
-80	39.00	-J	184.00																																																					
-92	29.00	-SS	92.00																																																					
-ARE	35.00	-TSI	POA																																																					
-CP (5A)	171.00	-VP	32.00																																																					
 <p>FD-210-4CP</p>	<p>PVC BODY w/SOLVENT WELD OUTLET AND 4" ADJUSTABLE ROUND CHROME PLATED BRASS STRAINER</p> <table border="1"> <thead> <tr> <th colspan="2">LIST PRICE</th> </tr> </thead> <tbody> <tr> <td>PIPE SIZE</td> <td>FD-210-4CP</td> </tr> <tr> <td>2", 3", 4"</td> <td>\$364.00</td> </tr> </tbody> </table> <p>ADD FOR OPTIONS:</p> <table> <tr> <td>-TSI</td> <td>POA</td> </tr> </table>	LIST PRICE		PIPE SIZE	FD-210-4CP	2", 3", 4"	\$364.00	-TSI	POA	 <p>FD-250J-S</p>	<p>CAST IRON BODY w/ADJUSTABLE SQUARE NIKALOY STRAINER AND NO-HUB BOTTOM OUTLET</p> <table border="1"> <thead> <tr> <th colspan="4">LIST PRICE</th> </tr> <tr> <th>PIPE SIZE</th> <th colspan="3">WITH STRAINER</th> </tr> </thead> <tbody> <tr> <td rowspan="2">4"</td> <td>5S</td> <td>6S</td> <td>8S</td> </tr> <tr> <td>\$728.00</td> <td>\$826.00</td> <td>\$1,262.00</td> </tr> </tbody> </table> <p>ADD FOR OPTIONS:</p> <table> <tr> <td>-2</td> <td>Deduct \$44.00</td> <td>-CP (6S)</td> <td>\$171.00</td> </tr> <tr> <td>-80</td> <td>39.00</td> <td>-J</td> <td>184.00</td> </tr> <tr> <td>-92</td> <td>29.00</td> <td>-SS</td> <td>92.00</td> </tr> <tr> <td>-ARE</td> <td>35.00</td> <td>-TSI</td> <td>POA</td> </tr> <tr> <td>-CP (5S)</td> <td>171.00</td> <td>-VP</td> <td>32.00</td> </tr> </table>	LIST PRICE				PIPE SIZE	WITH STRAINER			4"	5S	6S	8S	\$728.00	\$826.00	\$1,262.00	-2	Deduct \$44.00	-CP (6S)	\$171.00	-80	39.00	-J	184.00	-92	29.00	-SS	92.00	-ARE	35.00	-TSI	POA	-CP (5S)	171.00	-VP	32.00										
LIST PRICE																																																								
PIPE SIZE	FD-210-4CP																																																							
2", 3", 4"	\$364.00																																																							
-TSI	POA																																																							
LIST PRICE																																																								
PIPE SIZE	WITH STRAINER																																																							
4"	5S	6S	8S																																																					
	\$728.00	\$826.00	\$1,262.00																																																					
-2	Deduct \$44.00	-CP (6S)	\$171.00																																																					
-80	39.00	-J	184.00																																																					
-92	29.00	-SS	92.00																																																					
-ARE	35.00	-TSI	POA																																																					
-CP (5S)	171.00	-VP	32.00																																																					

LITE LINE FLOOR DRAINS



A WATTS Brand

FD-300J-A



PVC 2-PIECE FLOOR DRAIN w/1/2" PRIMER TAP w/PLUG, SOLVENT WELD BOTTOM OUTLET FOR SCH 40 PVC PIPE AND ADJUSTABLE ROUND NIKALOY STRAINER

LIST PRICE				
PIPE SIZE	WITH STRAINER			
	5A	6A	7A	8A
2", 3", 4"	\$609.00	\$755.00	\$876.00	\$1,112.00

ADD FOR OPTIONS:

-2.....Deduct \$44.00	-TSI..... POA
-49..... 128.00	-VP..... 32.00
-CP..... 171.00	

FD-370



PVC FLOOR DRAIN w/FLANGE, 9" PVC GRATE AND SOLVENT WELD BOTTOM OUTLET FOR SCH 40 PVC PIPE

LIST PRICE	
PIPE SIZE	FD-370
2", 3", 4"	\$601.00

ADD FOR OPTIONS:

-49..... \$128.00	-TSI..... POA
-50..... 128.00	
-B..... 135.00	
-HG..... \$0.00	

FD-300J-S

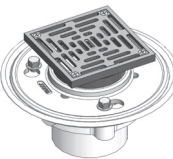

PVC 2-PIECE FLOOR DRAIN w/ 1/2" PRIMER TAP w/PLUG, SOLVENT WELD BOTTOM OUTLET FOR SCH 40 PVC PIPE AND ADJUSTABLE SQUARE NIKALOY STRAINER

LIST PRICE			
PIPE SIZE	WITH STRAINER		
	5S	6S	8S
2", 3", 4"	\$831.00	\$930.00	\$1,363.00

ADD FOR OPTIONS:

-2.....Deduct \$44.00	-VP..... 32.00
-49..... 128.00	
-CP..... 171.00	
-TSI..... POA	

Lite Line Floor Drain Option Descriptions

- ARE Acid-Resisting Epoxy
- B Bucket, PVC
- CP Chrome Plated
- HG 1/2 Grate, PVC
- J Backwater Valve
- MD PVC Clamp Collar with 3" Socket Connection
- SQ Square Rim
- SS Stainless Steel
- ST Shallow Trap
- TSI Trap Seal Insert
- VP Secured Grate, Vandal-Proof Screws
- 2 Satin Finish Bronze Top
- 49 3/4" Primer Tap
- 50 1/2" Primer Tap
- 80 Perforated Stainless Steel Basket
- 92 Galvanized Cast Iron Parts

Outlet

- T Threaded Outlet
- Y Hub Outlet with Gasket
- YGTC -Y Outlet Gasket with Test Cap
- Z No-Hub Outlet

FD-310



CAST IRON 2-PIECE FLOOR DRAIN w/1/2" TRAP PRIMER w/PLUG AND 5" ADJUSTABLE ROUND NIKALOY STRAINER

LIST PRICE		
TYPE NO.	PIPE SIZE	
FD-312-Y	2"	\$393.00
FD-312-Z	2"	393.00
FD-313-Z	3"	393.00
FD-313-Y	3"	393.00
FD-314-Z	4"	393.00

ADD FOR OPTIONS:

-80..... \$44.00	-VP..... \$32.00
-TSI..... POA	-YGTC (2"-3")..... 41.00

LITE LINE FLOOR DRAINS (cont'd.)

LITE LINE ROOF DRAINS

FD-450J-A



PVC FLOOR DRAIN w/SOLVENT WELD BOTTOM OUTLET FOR SCH 40 PVC PIPE AND ADJUSTABLE ROUND NIKALOY STRAINER

LIST PRICE				
PIPE SIZE	WITH STRAINER			
3" x 4"	5A	6A	7A	8A
	\$478.00	\$625.00	\$747.00	\$981.00

ADD FOR OPTIONS:
 -2Deduct \$44.00 -VP \$32.00
 -TSI POA

RD-300



PVC BODY w/CAST IRON CLAMP RING, CAST IRON DOME AND SOLVENT WELD BOTTOM OUTLET

LIST PRICE	
PIPE SIZE	RD-300
2", 3", 4"	\$610.00

ADD FOR OPTIONS:
 -17 \$246.00 -UC \$192.00
 -R 192.00 -VP 32.00
 -RC 107.00

FD-450J-S



PVC FLOOR DRAIN w/SOLVENT WELD BOTTOM OUTLET FOR SCH 40 PVC PIPE AND ADJUSTABLE SQUARE NIKALOY STRAINER

LIST PRICE			
PIPE SIZE	WITH STRAINER		
3" x 4"	5S	6S	8S
	\$697.00	\$797.00	\$1,232.00

ADD FOR OPTIONS:
 -2Deduct \$44.00 -VP \$32.00
 -TSI POA

RD-700



FITSALL CLAMP RING AND HARDWARE FOR BOLT CENTERS 7-1/2" TO 11"

LIST PRICE	
RD-700	
	\$595.00

FD-500



PVC FLOOR DRAIN w/SOLVENT WELD BOTTOM OUTLET FOR SCH 40 PVC PIPE AND 5" ADJUSTABLE ROUND STRAINER

LIST PRICE		
PIPE SIZE	WITH STRAINER	
2", 3", 4"	-JJ5PVC	\$148.00
2", 3", 4"	-J5NB Nickel Bronze	148.00
2", 3", 4"	-J5SC Scoriated Gasketed Solid Cover	164.00

ADD FOR OPTIONS:
 -TSI POA

RD-700 TOP ASSY.



FITSALL TOP ASSEMBLY w/CAST IRON CLAMP RING, LARGE DOME AND HARDWARE

LIST PRICE		
700-AD	Aluminum Dome	\$1,073.00
700-CD	Cast Iron Dome	1,044.00
700-PD	Polypropylene Dome	890.00

ADD FOR OPTIONS:
 -VP \$32.00

Lite Line Floor Drains Option Descriptions

- SQ Square Rim
- TSI Trap Seal Insert
- VP Secured Grate, Vandal-Proof Screws
- 2 Satin Finish Bronze Top

Lite Line Roof Drains Option Descriptions

- R Drain Receiver
- RC Drain Receiver and Clips
- UC Underdeck Clamp
- VP Secured Dome, Vandal-Proof Screws
- 17 2" High Overflow Collar

LITE LINE FLOOR SINKS

LITE LINE CLEANOUTS

	12x12x6 PVC FLOOR SINK w/ MEDIUM-DUTY FULL PVC GRATE, ALUMINUM INTERNAL DOME STRAINER AND SOLVENT WELD OUTLET FOR SCH 40 PVC PIPE	
	LIST PRICE	
	PIPE SIZE	FS-940
	2", 3", 4"	\$893.00
ADD FOR OPTIONS:		
-3Q.....	\$0.00	-NB\$1,247.00
-HG.....	0.00	-TSI..... POA
-LG.....	Deduct 223.00	

	8x8x6 ACID-RESISTING INTERIOR FLOOR SINK AND FULL GRATE w/ALUMINUM INTERNAL DOME STRAINER AND NO-HUB OUTLET	
	LIST PRICE	
	PIPE SIZE	FS-100
	2", 3", 4"	\$1,335.00
ADD FOR OPTIONS:		
-3.....	\$0.00	-33..... \$550.00
-4.....	0.00	-LG.....Deduct 347.00
-31.....	342.00	-TSI..... POA

	12x12x6 ACID-RESISTING INTERIOR FLOOR SINK AND FULL GRATE w/ALUMINUM INTERNAL DOME STRAINER AND NO-HUB OUTLET	
	LIST PRICE	
	PIPE SIZE	FS-120
	2", 3", 4"	\$1,409.00
ADD FOR OPTIONS:		
-3.....	\$0.00	-33..... \$601.00
-4.....	0.00	-LG.....Deduct 396.00
-31.....	434.00	-TSI..... POA

	12x12x8 ACID-RESISTING INTERIOR FLOOR SINK AND FULL GRATE w/ALUMINUM INTERNAL DOME STRAINER AND NO-HUB OUTLET	
	LIST PRICE	
	PIPE SIZE	FS-140
	2", 3", 4"	\$1,505.00
ADD FOR OPTIONS:		
-3.....	\$0.00	-33..... \$601.00
-4.....	0.00	-LG.....Deduct 396.00
-31.....	434.00	-TSI..... POA

	12x12x10 ACID-RESISTING INTERIOR FLOOR SINK AND FULL GRATE w/ALUMINUM INTERNAL DOME STRAINER AND NO-HUB OUTLET	
	LIST PRICE	
	PIPE SIZE	FS-160
	2", 3", 4"	\$2,007.00
ADD FOR OPTIONS:		
-3.....	\$0.00	-33..... \$601.00
-4.....	0.00	-LG.....Deduct 396.00
-31.....	434.00	-TSI..... POA

	LEVELEZE® II C.I. CLEANOUT w/5" ROUND TOP, INTERNAL PLUG AND TWO-STAGE HEIGHT ADJUSTMENT	
	LIST PRICE	
	PIPE SIZE	CO-100-A
	2"-5"*	\$702.00
ADD FOR OPTIONS:		
-VP.....	\$32.00	-YGTC (2"-4")..... 41.00
-Y.....	0.00	-Z..... \$0.00
*5" available in no-hub only		

	LEVELEZE® II C.I. CLEANOUT w/5" SQUARE TOP, INTERNAL PLUG AND TWO-STAGE HEIGHT ADJUSTMENT	
	LIST PRICE	
	PIPE SIZE	CO-100-S
	2"-5"*	\$819.00
ADD FOR OPTIONS:		
-VP.....	\$32.00	-YGTC (2"-4")..... 41.00
-Y.....	0.00	-Z..... \$0.00
*5" available in no-hub only		

	CAST IRON CLEANOUT, ADJUSTABLE NIKALOY RIM AND COVER AND INTEGRAL GAS-TIGHT THREADED PLUG	
	LIST PRICE	
	TYPE NO.	PIPE SIZE
	CO-312-Y	2"
CO-312-Z	2"	393.00
CO-313-Z	3"	393.00
CO-313-Y	3"	393.00
CO-314-Z	4"	393.00
ADD FOR OPTIONS:		
-SQ Square Nickel Bronze Rim and Cover		\$44.00
-VP Secured Cover, Vandal-Proof Screws		32.00
-YGTC (2"-3").....		41.00

	PVC CLEANOUT w/ROUND (NIKALOY or CAST IRON) TOP w/BRONZE PLUG AND SOLVENT WELD BOTTOM OUTLET FOR FITTING OVER 3" AND INSIDE 4" SCH 40 DWV	
	LIST PRICE	
	PIPE SIZE	CO-430
	3" x 4" - Nikaloy	\$669.00
3" x 4" - Cast Iron	852.00	
ADD FOR OPTIONS:		
-2*.....Deduct \$44.00		-VP..... \$32.00
-14.....		69.00
*For Nikaloy Top only		

	CAST IRON CLEANOUT w/SECURED ROUND CAST IRON RIM AND COVER w/INTEGRAL BRASS PLUG AND 4" NO-HUB OUTLET	
	LIST PRICE	
	PIPE SIZE	WITH STRAINER
	4"	-CI Rim and Cover (Std)
4"	-NB Nikaloy Rim and Cover	857.00
4"	-NB-SQ Square Nikaloy Rim and Cover	857.00

Lite Line Floor Sink Option Descriptions

- HG 1/2 Grate (PVC)
- 3Q 3/4 Grate (PVC)
- LG Less Grate
- NB Nickel Bronze
- TSI Trap Seal Insert
- 3 1/2 Grate (Acid-Resisting)
- 4 3/4 Grate (Acid-Resisting)
- 31 Aluminum Sediment Bucket
- 33 Acid-Resisting Finish Sediment Bucket

Lite Line Cleanout Option Descriptions

- 2 Satin Finish Bronze Top
- 14 Carpet Cleanout Marker
- SQ Square Nickel Bronze Rim and Cover
- VP Secured Cover, Vandal-Proof Screws
- Outlets
- Y Hub Outlet w/Gasket 2" - 4"
- YGTC -Y Outlet Gasket w/Test Cap
- Z No-Hub Outlet

LITE LINE GREASE INTERCEPTORS

 JG-0100S	MANUAL CLEANING ON-FLOOR TYPE					
	TYPE NO.	PIPE SIZE	FLOW RATE GPM	GREASE CAPACITY LBS.	LIST PRICE	FOR OPTION, ADD TO LIST PRICE
						-EXT 6"
JG-0102S	2	7	14	\$3,520.00		\$2,506.00
JG-0103S	2	10	20	4,016.00		3,178.00
JG-0104S	2	15	30	4,762.00		3,346.00
JG-0105S	3	20	40	5,354.00		3,624.00
JG-0106S	3	25	50	7,249.00		3,903.00
JG-0107S	3	35	70	8,693.00		4,574.00
JG-0108S	3	50	100	9,944.00		7,249.00
JG-0109S	3	75	150	20,751.00		12,264.00
JG-0110S	4	100	200	25,467.00		13,932.00
ADD FOR OPTIONS:						
-EXTABOVE						

LITE LINE SHOCK ABSORBERS

 SA	COPPER SHELL SHOCK ABSORBERS		
	SIZE	PIPE CONNECTION	LIST PRICE
SA-A	1/2	\$250.00	
SA-B	3/4	288.00	
SA-C	1	612.00	
SA-D	1	729.00	
SA-E	1	1,636.00	
SA-F	1	2,460.00	

LITE LINE SHALLOW TRENCH DRAIN PRODUCTS

Part Number	Channel Size	Grate	Grate Size	Load Class	ADA/HP	List Price Per Foot*
TD-130-ABS	39.4"	ABS Perforated	19.7"	A	ADA/HP	\$287.00
TD-130-GALV	39.4"	Galvanized Steel Slotted	39.4"	A	ADA	\$336.00
TD-130-SS	39.4"	Stainless Steel Slotted	39.4"	A	ADA	\$610.00
TD-130-CI	39.4"	Cast Iron Diagonal Slotted	19.7"	C	ADA	\$368.00

Above pricing includes Neutral HDPE Channel, Grate, and Lock Bar. *Pricing is estimated per foot price. Final orders are to be rounded to nearest 39.4".

ADD FOR OPTIONS:

-ECS..... \$268.00	-110GSKT.....\$16.00	-SSE.....\$285.00*	-GSE.....\$134.00*
-GABS.....\$209.00	-GGALV.....\$377.00	-GSS.....\$1,339.00	-GCI.....\$402.00
			-LBK**.....\$30.00

*This pricing is estimated per foot price. Final orders are to be rounded to nearest 39.4". **Required every 19.7" when ordering replacement grates.

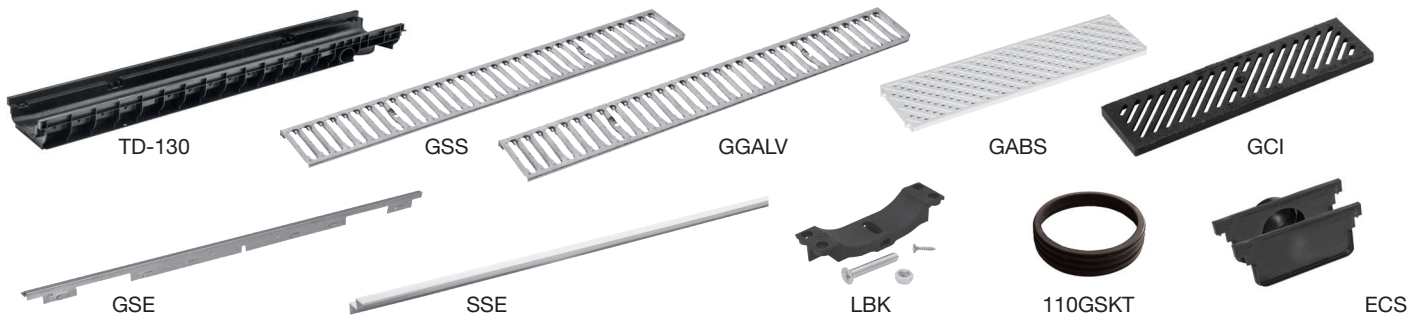

Lite Line Trench Drain Option Descriptions

-TD-130	Channel	-ECS	End Cap Set
-GABS	ABS Perforated Grate	-LBK	Lock Bar Kit
-GCI	Cast Iron Diagonal Slotted Grate	-110GSKT	Gasket
-GGALV	Galvanized Steel Slotted Grate	-SSE	Stainless Steel Edge
-GSS	Stainless Steel Slotted Grate	-GSE	Galvanized Steel Edge

Superior Packaging, Labeling and Shipping

Josam ships its products pre-packaged, labeled with part numbers, and partially assembled at no extra charge!



Each item is individually wrapped and upon request tagged with specific product designations for easy on-site identification and transportation

Shrink wrapping protects product from harsh weather conditions and reduces lost parts

All Josam shrink wrap material is environmentally friendly and biodegradable



A **WATTS** Brand

USA: T: (800) 365-6727 • Josam.com